

## Notice of Extraordinary General Meeting

12 March 2025

ASX Markets Announcement Office  
Exchange Centre  
20 Bridge Street  
Sydney NSW 2000

### Notice of Extraordinary General Meeting

Please find attached for release to the market, the following documents in relation to Xanadu Mining Ltd's Extraordinary General Meeting (EGM), to be held on **Friday, 11 April 2025 commencing at 11:00am (AEST) at the Royal Automotive Club of Victoria, Level 1 501 Bourke Street Melbourne VIC 3000.**

- *Notice of Meeting*
- *Proxy Form*
- *AGM Notice Letter* - to be sent to members in lieu of the full Notice of Meeting; and

The Notice of Meeting will be available on Xanadu's website at: <https://www.xanadumines.com/shareholder-meetings/>.

-ENDS-

#### For further information, please contact:

Colin Moorhead  
Executive Chairman & Managing Director  
P: +61 2 8280 7497  
E: [colin.moorhead@xanadumines.com](mailto:colin.moorhead@xanadumines.com)  
W: [www.xanadumines.com](http://www.xanadumines.com)

Spencer Cole  
Chief Financial Officer  
P: +61 2 8280 7497  
E: [spencer.cole@xanadumines.com](mailto:spencer.cole@xanadumines.com)

*This Announcement was authorised for release by Xanadu's Board of Directors.*

For information on Xanadu visit: [www.xanadumines.com](http://www.xanadumines.com).

XANADU MINES

---

# **EXTRAORDINARY GENERAL MEETING**

For personal use only

**11 April 2025**

# XANADU MINES

12 March 2025

Dear Shareholders,

On behalf of the Directors of Xanadu Mines Ltd (the **Company** or **Xanadu Mines**), I am pleased to invite you to participate in an Extraordinary General Meeting (**EGM** or **Meeting**) of the Company. Enclosed is the *Notice of Meeting* setting out the business of the EGM.

The Company's EGM will be held on Friday 11 April 2025 commencing at 11:00AM (Sydney/Melbourne time) at the Royal Automotive Club of Victoria, Level 1, 501 Bourke Street, Melbourne Victoria 3000.

Shareholders who cannot physically attend the EGM, will be able to participate in our EGM by:

- asking questions of the Board and the auditor before the EGM by lodging questions online at [www.investorvote.com.au/xam](http://www.investorvote.com.au/xam); and/or
- voting on the resolutions to be considered at the EGM by lodging the Proxy Form provided by the Share Registry before the EGM.

If you are physically attending the EGM, please bring your Proxy Form with you to facilitate a faster registration. If you are unable to physically attend the EGM, I encourage you to complete and return the enclosed Proxy Form no later than 11:00AM (Sydney time) on Wednesday 9 April 2025 in one of the ways specified in the Notice of Meeting and the Proxy Form.

I encourage you to read the enclosed Notice of Meeting (including the Explanatory Memorandum) and the Proxy Form and consider directing your proxy how to vote on the resolutions by marking either the **For** box, the **Against** box or the **Abstain** box on the Proxy Form. Subject to the abstentions noted in the Explanatory Memorandum, the Directors of Xanadu Mines recommend that shareholders vote in favour of the resolutions.

*If you have any questions after reading the Notice of Meeting, please call the Shareholder Information Line on 1300 855 080 (within Australia) or +61 (03) 9415 4000 (outside Australia), Monday to Friday between 8:30am and 8:00pm (Sydney time).*

Thank you for your continued support of Xanadu Mines.

Yours faithfully,



**Colin Moorhead**  
**Executive Chairman and Managing Director**  
**Xanadu Mines Ltd**

**AUSTRALIA**  
c/o Company Matters Pty Limited  
Level 12, 680 George Street  
Sydney NSW 2000  
T: +612 8280 7497

**MONGOLIA**  
Suite 23, Building 9B  
Olympic St, Sukhbaatar District  
Ulaanbaatar, Mongolia  
T: +967 7012 0211

Xanadu Mines Ltd ACN 114 249 026  
[www.xanadumines.com](http://www.xanadumines.com)

For personal use only

**XANADU MINES LTD**  
**ABN 92 114 249 026**

**NOTICE OF EXTRAORDINARY GENERAL MEETING**

Notice is given that an Extraordinary General Meeting (**EGM** or **Meeting**) of shareholders of Xanadu Mines Ltd (the **Company** or **Xanadu Mines**) will be held:

**Date:** Friday 11 April 2025

**Time:** 11:00 am (Melbourne time)

**Venue:** Royal Automotive Club of Victoria, Level 1, 501 Bourke Street, Melbourne Victoria 3000

The Explanatory Memorandum accompanying this Notice of Meeting provides additional information on matters to be considered at the EGM is hereby incorporated into and forms part of this Notice of Meeting.

**ORDINARY BUSINESS**

**RESOLUTIONS**

**Resolution 1 Approval to exercise 25% Put Option in respect of Khuiten Metals Pte Ltd**

To consider and, if thought fit, pass, with or without amendment, the following as an Ordinary Resolution of the Company:

*“That, for the purposes of Listing Rule 10.1 and for all other purposes, the Company be authorised to exercise the put option granted by Jinping (Singapore) Mining Pte. Ltd. (a wholly owned indirect subsidiary of Zijin Mining Group Co. Ltd) (Zijin) to:*

- a) *dispose of a 25% interest in Khuiten Metals Pte Ltd (25% Put Option); and*
- b) *grant security over its remaining 25% interest in Khuiten Metals Pte Ltd (Security) to give effect to the Funding Loan,*

**(Proposed Transaction)**, in accordance with the terms and conditions of the Joint Venture Shareholders' Agreement, the details of which are summarised in the Explanatory Memorandum.”

**Independent Expert's Report**

Shareholders should carefully consider the Independent Expert's Report included at Schedule 2 of this Notice of Meeting, prepared by BDO Corporate Finance Ltd (**Independent Expert**) for the purposes of Listing Rule 10.5.10.

The Independent Expert has concluded that the transaction being approved under Resolution 1 is fair and reasonable to the Non-Associated Shareholders.

**Voting exclusion statement**

The Company will disregard any votes cast in favour of this Resolution 1 by or on behalf of:

- Jinping (Singapore) Mining Pte. Ltd.; or
- an associate of Jinping (Singapore) Mining Pte. Ltd.

However, this does not apply to a vote cast in favour of Resolution 1 by:

- a person as proxy or attorney for a person who is entitled to vote on Resolution 1, in accordance with directions given to the proxy or attorney to vote on Resolution 1 in that way; or
- the chair of the Meeting as proxy or attorney for a person who is entitled to vote on Resolution 1, in accordance with a direction given to the chair of the Meeting to vote on Resolution 1 as the chair of the Meeting decides; or
- a holder acting solely in a nominee, trustee, custodial or other fiduciary capacity on behalf of a beneficiary provided the following conditions are met:
  - the beneficiary provides written confirmation to the holder that the beneficiary is not excluded from voting, and is not an associate of a person excluded from voting, on the Resolution; and
  - the holder votes on Resolution 1 in accordance with directions given by the beneficiary to the holder to vote in that way.

## **Resolution 2      Ratification of prior issue of 110,000,004 shares**

To consider and, if thought fit, pass, with or without amendment, the following as an Ordinary Resolution of the Company:

*“That, the issue on 8 November 2024 of a total of 100,00,004 fully paid ordinary shares in Xanadu Mines Ltd (**Shares**) and a further issue of 10,000,000 Shares on 15 November 2024 at an issue price of \$0.055 per Share to those unrelated professional, sophisticated or other investors that fall within one or more of the classes of exemptions specified in section 708 of the Corporations Act (**Participants**) on the terms and conditions set out in the Explanatory Memorandum accompanying this Notice, is approved under and for the purposes of ASX Listing Rule 7.4 and for all other purposes.”*

### Voting Exclusion Statement

The Company will disregard any votes cast in favour of this Resolution 2 by or on behalf of the Participants or an associate of any Participant.

However, this does not apply to a vote cast in favour of Resolution 2 by:

- a person as proxy or attorney for a person who is entitled to vote on Resolution 2, in accordance with the directions given to the proxy or attorney to vote on Resolution 2 in that way; or
- the chair of the Meeting as proxy or attorney for a person who is entitled to vote on Resolution 2 in accordance with a direction given to the chair of the Meeting to vote on Resolution 2 as the chair of the Meeting decides; or
- a holder acting solely in a nominee, trustee, custodial or other fiduciary capacity on behalf of a beneficiary provided the following conditions are met:
  - the beneficiary provides written confirmation to the holder that the beneficiary is not excluded from voting, and is not an associate of a person excluded from voting, on Resolution 2; and
  - the holder votes on Resolution 2 in accordance with directions given by the beneficiary to the holder to vote in that way.

### ENTITLEMENT TO ATTEND AND VOTE

In accordance with Regulation 7.11.37 of the *Corporations Regulations 2001 (Cth)*, the Board has determined that persons who are registered holders of shares of the Company as at 7pm (Sydney/Melbourne time) on 9 April 2025 will be entitled to attend and vote at the EGM as a shareholder. Accordingly, transactions registered after that time will be disregarded for determining which shareholders are entitled to participate and vote at the EGM.

If more than one joint holder of shares is present at the EGM (whether personally, by proxy or by attorney or by representative) and tenders a vote, only the vote of the joint holder whose name appears first on the register is counted.

### **All resolutions will be by poll**

In accordance with rule 27 of the Company's Constitution, the Chairman of the Meeting intends to demand a poll on each of the resolutions proposed at the EGM. Each resolution considered at the EGM will therefore be conducted by a poll, rather than on a show of hands. The Chairman of the Meeting considers voting by poll to be in the best interests of the shareholders as a whole and is a way to ensure the views of as many shareholders as possible are represented at the Meeting.

### **Appointment of Proxy**

If you are a shareholder entitled to attend and vote, you may appoint an individual or a body corporate as a proxy. If a body corporate is appointed as a proxy, that body corporate must ensure that it appoints a corporate representative in accordance with section 250D of the Corporations Act to exercise its powers as proxy at the EGM. A proxy need not be a shareholder of the Company.



**ENCLOSURES**

Enclosed with the copy of this Notice sent to you by the Share Registry (or accessed through its website) are the following documents:

- **Proxy Form** to be completed if you would like to be represented at the EGM by proxy. Shareholders are encouraged to use the online voting facility that can be accessed on Xanadu Mines' share registry's website at [www.investorvote.com.au/xam](http://www.investorvote.com.au/xam) to ensure the timely and cost-effective receipt of your proxy;
- a **reply-paid envelope** for you to return the Proxy Form.

*If you have any questions after reading the Notice of Meeting, please call the Shareholder Information Line on 1300 855 080 (within Australia) or +61 (03) 9415 4000 (outside Australia), Monday to Friday between 8:30am and 8:00pm (Sydney time).*

BY ORDER OF THE BOARD



**William Hundy**  
**Company Secretary**  
12 March 2025

For personal use only

## EXPLANATORY MEMORANDUM

This Explanatory Memorandum has been prepared to assist shareholders of the Company (**Shareholders**) in considering each of the Resolutions set out in the Company's *Notice of Extraordinary General Meeting*. This Explanatory Memorandum forms part of the Company's Notice of Extraordinary General Meeting to be held at **11:00 AM (Melbourne time) on 11 April 2025**.

The purpose of this Explanatory Memorandum is to provide Shareholders with information that is reasonably required by Shareholders to decide how to vote upon each Resolution. The Company's Notice of Extraordinary General Meeting and this Explanatory Memorandum should be read in their entirety and in conjunction with each other.

Subject to the abstentions noted below, the Directors unanimously recommend that Shareholders vote in favour of each Resolution. The Chairman of the Meeting intends to vote all available undirected proxies in favour of each Resolution.

Each Resolution is an ordinary resolution, which requires that a simple majority of votes cast by Shareholders present and entitled to vote on each Resolution must be in favour of the relevant Resolution.

### BACKGROUND TO THE ITEMS OF BUSINESS

#### Resolution 1 Approval to enter into Proposed Transaction with Zijin in respect of Khuiten Metals Pte Ltd

##### Joint Venture with Zijin

On 10 March 2023, the Company announced the completion of Phase 2 and Phase 3 of its strategic partnership with Zijin Mining Group Co., Ltd. (**Zijin**). Phase 3 of the strategic partnership involved the creation of a 50/50 joint venture in Khuiten Metals Pte Ltd (**Khuiten Metals**), which holds an effective interest of 76.5% in the Kharmagtai Copper-Gold Project (**Kharmagtai Project**), with Jinping (Singapore) Mining Pte. Ltd., a wholly owned indirect subsidiary of Zijin Mining Group Co. Ltd (**Zijin**), pursuant to the Joint Venture Shareholders' Agreement dated 21 December 2022 (**JV Shareholders' Agreement**).

##### Put Options

Under the JV Shareholders' Agreement, upon the Company delivering a Pre-Feasibility Study (**PFS**) which meets the required guidelines, the Company is entitled to exercise one of two put options to require Zijin to acquire from Xanadu:

- a. a further 25% interest in Khuiten Metals for a payment to the Company of US\$25,000,000 (**25% Put Option**); or
- b. its full 50% interest in Khuiten Metals for a payment to the Company of US\$50,000,000 (**50% Put Option**).

The Company may only exercise one of the above options, and the exercise must occur within six months following the delivery of the PFS (**Put Option Exercise Period**).

The PFS was delivered to Zijin and announced to the market on 14 October 2024. Accordingly, the Company is now entitled to exercise either of the above put options during the Put Option Exercise Period, which expires on 14 April 2025. The Company must obtain any shareholder approval or other regulatory approvals necessary in order to exercise either of the options.

The Company does not presently intend to exercise the 50% Put Option.

##### Funding Loan

In circumstances where Xanadu exercises the 25% Put Option, it will then remain liable for its respective proportion of the funding for the progression of the joint venture until commencement of commercial production at the Kharmagtai Project. This would be funded by way of a loan from Zijin (**Funding Loan**) to cover all of Xanadu's share of certain costs for the Kharmagtai Project, to be repaid out of operating dividends post construction, on the following key terms:

- *Facility limit:* up to Xanadu's respective proportion of funding amounts required under the JV Shareholders' Agreement until commencement of commercial production at the Kharmagtai Project;



- *Mandatory prepayments:* 90% of dividends and distributions due to Xanadu by Khuiten Metals will be directed to Zijin and applied in payment of the Funding Loan (interest before principal);
- *Repayment date:* 10 years from the date of the commencement of the commercial production of the Kharmagtai Project or upon earlier termination of the joint venture or default by Xanadu;
- *Interest rate:* the secured overnight financing rate (**SOFR**) (based on a 6-month term) + 5% per annum;
- *Security:* Xanadu's entire shareholding in Khuiten Metals (which would be a 25% interest following exercise of the 25% Put Option) (**Security**); and
- the Funding Loan will rank in priority to distributions to shareholders.

A more detailed summary of the JV Shareholders' Agreement and the Funding Loan is attached as Schedule 1.

### **Proposed Transaction**

In order to maintain flexibility with respect to its strategic options going forward, Xanadu is seeking shareholder pre-approval prior to the end of the Put Option Exercise Period, to enable it to:

- a) exercise the 25% Put Option to dispose of a 25% interest in Khuiten Metals; and
- b) grant the Security under the Funding Loan,

(**Proposed Transaction**), if resolved by the Company.

Exercise of the 25% Put Option and entry into the Funding Loan by the Company are conditional upon each other under the JV Shareholders' Agreement.

Accordingly, Resolution 1 seeks Shareholder approval to enter into the Proposed Transaction, comprising the exercise of the 25% Put Option and the granting of Security under the Funding Loan.

### **Rationale for the Proposed Transaction**

#### *Overview*

The Proposed Transaction was established to ensure that, in the absence of a better offer, Xanadu would be able to deliver value to Shareholders through long term exposure to the Kharmagtai Project. It addresses the risk of dilution if the project moves forward at a pace Xanadu cannot fund, or value deferral if the project is slowed due to decisions by either joint venture partner.

The Board would not execute the Proposed Transaction if there were a corporate or asset level transaction judged to provide greater value than the Proposed Transaction. A funding solution for the Feasibility Study does not achieve this, because while it does preserve Xanadu's existing 50% interest in the project until FID, Xanadu would no longer have the zero cash outlay put option available to it, and dilution during construction would result in far more dilution than what is contemplated under the Proposed Transaction.

#### *Key benefits of the Proposed Transaction*

The Proposed Transaction provides the following benefits to Xanadu, creating value for Shareholders in the absence of a better offer:

- avoids dilution;
- creates a long-term annuity for Xanadu in the generational Kharmagtai Copper-Gold Project;
- provides cash to the Company of US\$25 million; and
- results in the Kharmagtai Project being operated by a global mining major and top 5 copper and gold producer.

#### *Risks relating to the Proposed Transaction*

The risks of the Proposed Transaction are tied to Zijin's capability as the operator of the Kharmagtai Project. These include:

- Zijin as operator delays the project, which defers longer term value to Xanadu; and

- Zijin as operator is unable to deliver full project value, reducing the value of Xanadu's interest in the project.

*Use of funds*

Exercise of the 25% Put Option will result in a transformed Xanadu Mines, with a strong cash stake and 25% ownership in a long-term copper-gold producing mine. To prepare for this, Xanadu's next steps will be to re-establish its project portfolio via one or more transactions to acquire new projects. This could potentially include corporate as well as asset level acquisitions. In parallel, Xanadu would restructure for operation of its new projects and for careful technical and commercial monitoring of Kharmagtai Project progress under Zijin's operatorship, which would include a continued seat on the Khuiten Metals Board of Directors.

**Timetable of the Proposed Transaction**

It is anticipated that the Proposed Transaction will be implemented in accordance with the below timetable:

Event	Date
Dispatch of Notice of Extraordinary General Meeting	Wednesday, 12 March 2025
Extraordinary General Meeting held	Friday, 11 April 2025
Issue 25% Put Option Exercise Notice to Zijin (if exercised)	On or about Friday, 11 April 2025
25% Put Option expiry (if not exercised)	Monday, 14 April 2025
25% Put Option Completion Date and entry into the Funding Loan	On or about Wednesday, 11 June 2025

**Listing Rule 10.1**

Listing Rule 10.1 requires a listed entity to obtain Shareholder approval prior to the disposal of a substantial asset by the entity (or a subsidiary of the entity) to certain persons, including, relevantly:

- 10.1.3 - a person who is, or was at any time in the 6 months before the transaction or agreement, a substantial (10%+) holder in the entity;
- 10.1.4 - an associate of a person referred to in 10.1.3; or
- 10.1.5 - a person whose relationship to the entity or a person referred to in 10.1.1 to 10.1.4 is such that, in ASX's opinion, the transaction should be approved by security holders.

For the purposes of the Listing Rules, an asset is a substantial asset if its value or the value of the consideration being received by the entity for the asset is 5% or more of the equity interests of the Company, as set out in the latest accounts given to ASX by the Company.

Based on the Company's latest accounts given to the ASX, as at 30 June 2024, the Company's equity interests is AU\$64.5 million. The aggregate estimated value of the Proposed Transaction is over US\$25 million (being the Purchase Price for the 25% Put Option).

For the purposes of the Listing Rules, dispose is given a broad meaning and includes exercising an option to dispose of an asset, as well as granting a security interest over an asset.

Both limbs of the Proposed Transaction fall within Listing Rule 10.1, given that:

- Jinping (Singapore) Mining Pte. Ltd. is a wholly owned indirect subsidiary of Zijin and is therefore an associate for the purposes of the Listing Rules;
- Zijin holds approximately 18.82% of Xanadu's total issued share capital as at the date of this Notice and is therefore a substantial (10%+) holder; and
- the Proposed Transaction involves two interrelated disposals of substantial assets, given that the consideration payable for the Proposed Transaction and the associated disposals is US\$25 million plus the granting of the Funding Loan.

For personal use only

On the above basis, the Proposed Transaction will result in the disposal of a substantial asset to an associate of a substantial (10%+) holder, by way of the exercise of the 25% Put Option and the granting of Security under the Funding Loan. Accordingly, the Company is required to seek shareholder approval under Listing Rule 10.1.

### Information for Listing Rule 10.5

As set out above, Resolution 1 seeks the approval of two interrelated disposals under the Proposed Transaction, being the:

- a) exercise of the 25% Put Option to dispose of a 25% interest in Khuiten Metals; and
- b) grant of Security under the Funding Loan.

For the purposes of Listing Rule 10.5, the Company provides the following information as it relates to each disposal:

Listing Rule	Information	
	Exercise of the 25% Put Option	Grant of the Security
10.5.1 - The name of the person to whom the entity is disposing of the substantial asset.	Jinping (Singapore) Mining Pte. Ltd.	
10.5.2 - Which category in rules 10.1.1 – 10.1.5 the person falls within and why.	Jinping (Singapore) Mining Pte. Ltd. is a wholly owned indirect subsidiary of Zijin Mining Group Co. Ltd. Zijin (together with its associates) holds approximately 18.82% of Xanadu's total issued share capital. Accordingly, Jinping (Singapore) Mining Pte. Ltd falls within Listing Rule 10.1.4. as an associate of a substantial (10%+) holder.	
10.5.3 - Details of the asset being disposed of.	If the 25% Put Option is exercised, Xanadu will dispose of a 25% interest in Khuiten Metals to Jinping (Singapore) Mining Pte. Ltd.	Under the Funding Loan, Xanadu is required to grant security over its entire shareholding in Khuiten Metals, which will represent a 25% interest in Khuiten Metals following exercise of the 25% Put Option.
10.5.4 - The consideration for the disposal.	The purchase price under the 25% Put Option is US\$25 million.	The Company will be granted a loan facility for all funding amounts payable by the Company under the JV Shareholders' Agreement until commencement of commercial production at the Kharmagtai Project. In addition, the Company will receive the US\$25 million consideration as part of the Proposed Transaction.
10.5.5 - In the case of an acquisition, the intended source of funds (if any) to pay for the acquisition	Not applicable.	
10.5.6 - In the case of a disposal, the intended use of funds (if any) received for the disposal.	The intended use of funds for the exercise of the 25% Put Option is included under the heading " <b>Use of Funds</b> " in the section preceding this table.	The Funding Loan will be used to provide all funding amounts payable by the Company under the JV Shareholders' Agreement until commencement of commercial production at the Kharmagtai Project

For personal use only

Listing Rule	Information	
	Exercise of the 25% Put Option	Grant of the Security
10.5.7 - The timetable for completing the disposal.	The anticipated timetable for the Proposed Transaction is included under the heading “ <b>Timetable of the Proposed Transaction</b> ” in the section preceding this table.	
10.5.8 - If the disposal is occurring under an agreement, a summary of any other material terms of the agreement	Summaries of the JV Shareholders’ Agreement and the Funding Loan are included in Schedule 1.	
10.5.9 - A voting exclusion statement.	A voting exclusion statement is included in the Notice of Meeting.	
10.5.10 - A report on the transaction from an independent expert	The Independent Expert’s Report is summarised under the heading “ <b>Independent Expert’s Report</b> ” in the section following this table and set out in full in Schedule 2.	

### Independent Expert’s Report

Accompanying this Explanatory Memorandum at Schedule 2 is an Independent Expert’s Report (**IER**) prepared by BDO Corporate Finance Ltd (**Independent Expert**). The IER provides a detailed analysis of the Proposed Transaction, and the Independent Expert has concluded that the Proposed Transaction is fair and reasonable to Non-Associated Shareholders.

The Independent Expert Report is in part for the purpose of assisting the Non-Associated Shareholders’ consideration and assessment of the merits of the Proposed Transaction and the making of their decision whether to vote in favour of Resolution 1. Shareholders are urged to carefully read the Independent Expert Report, to understand the scope of the report, the methodology of the valuation and the assumptions made.

A copy of the Independent Expert Report has been provided or made available to each Shareholder entitled to receive this Notice of Meeting and Explanatory Memorandum. Irrespective of this, a copy of the Independent Expert Report is available on the Company’s website at [www.xanadumines.com/asx-announcements/](http://www.xanadumines.com/asx-announcements/) and hard copies, free of charge, may be requested by a Shareholder by contacting the Company’s registered office.

### Implications if Resolution 1 is passed

If Resolution 1 is passed, the Company will be able to proceed with the Proposed Transaction, which is anticipated to have the advantages summarised under the heading “**Rationale for the Proposed Transaction**” in the Background to Resolutions 1 and 2.

### Implications if Resolution 1 is not passed

If Resolution 1 is not passed, the Company will not be able to proceed with the Proposed Transaction. In those circumstances, the Company will retain its 50% interest in Khuiten Metals and will need to consider other means available for the Company to fund the progression of the joint venture until commencement of commercial production at the Kharmagtai Project. The Directors consider that if the Proposed Transaction is not completed, then other sources of funding will be required which may be on less favourable terms to the Company and to Shareholders.

If Resolution 1 is not passed, then as 50% shareholder in the Kharmagtai Project, Xanadu would need an estimated US\$25-30 million for its share of the Bankable Feasibility Study (**BFS**) stage, running into late 2026 or early 2027, to be followed by 2-3 years of construction and commissioning, of which the Company’s share is estimated to cost US\$425-450 million. If Xanadu is unable to fund either of these stages, then it would need to either materially slow the Kharmagtai Project or accept significant dilution of its interest in the project.

Xanadu has been working closely with its funding adviser Bacchus Capital to establish funding options. Due to the stage of the Kharmagtai Project and the scale of Xanadu, funding for construction cannot yet be achieved. Term sheets have been received that could fund the Company’s share of the BFS, which include packages of debt, equity, offtake and royalties, noting that debt, offtake and royalty options all require collateral commitments from the joint venture with Zijin.

For personal use only

Xanadu is in discussion with Zijin about these collateral commitments but has not received firm commitments of support. As a result, there remains a material risk that Zijin as 50% joint venture partner will block debt, offtake and royalty options. Therefore, at this point, the Board judges the only high confidence option for BFS funding will be equity at the Xanadu level.

By this logic, if exercise of the 25% Put Option is not approved by Shareholders, and in the absence of a better offer, Xanadu would plan to raise the required US\$25-30 million (A\$38-46 million as at the date of this Notice) via equity. In parallel the effort would commence to find a funding solution for the much larger construction costs, noting that a completed BFS would be required before construction funding could truly be finalised.

#### **Director's recommendation**

For the reasons set out above, the Directors (with Shaoyang Shen abstaining) unanimously recommend Shareholders vote in favour of Resolution 1. In the interests of corporate governance, Mr Shen has not provided a recommendation in respect of Resolution 1.

#### **Resolution 2 Ratification of prior issue of 110,000,004 shares**

On 8 November 2024, the Company issued 100,000,004 fully paid ordinary shares and made a further issue of 10,000,000 Shares on 15 November 2024 at an issue price of \$0.55 per share (**Placement Shares**) to unrelated professional, sophisticated or other investors that fall within one or more of the classes of exemptions specified in section 708 of the Corporations Act (**Placement Participants**) who participated in a private placement of Shares (**Placement**).

ASX Listing Rule 7.1 prohibits the Company (subject to certain exceptions such as pro-rata issues) from issuing or agreeing to issue equity securities (such as Shares and Options) representing more than 15% of the Company's total issued securities, during a rolling 12-month period, without Shareholder approval (**15% Threshold**).

ASX Listing Rule 7.4 provides that where a company in general meeting ratifies the previous issue of securities made pursuant to ASX Listing Rule 7.1 (and provided that the previous issue did not breach ASX Listing Rule 7.1) those securities will be deemed to have been made with Shareholder approval for the purpose of ASX Listing Rule 7.1.

The Placement was made within the 15% Threshold permitted under ASX Listing Rule 7.1 without Shareholder approval. Accordingly, the Company is seeking approval of Resolution 2 for the purposes of ASX Listing Rule 7.4, to enable the Company to refresh its issuing capacity under ASX Listing Rule 7.1, thereby providing the Company with the flexibility to issue equity securities in the future up to the 15% Threshold set out in ASX Listing Rule 7.1, without the requirement to obtain prior Shareholder approval if the need arises in the next 12 months.

If Shareholders approve Resolution 2, the Placement Shares will be excluded in calculating Xanadu Mines' 15% limit in ASX Listing Rule 7.1, effectively increasing the number of equity securities it can issue without Shareholder approval over the 12-month period following the issue of the Tranche 1 Shares.

If Shareholders do not approve Resolution 2, the Placement Shares will be included in calculating Xanadu Mines' 15% limit under ASX Listing Rule 7.1, effectively decreasing the number of equity securities it can issue without Shareholder approval over the 12-month period following the issue of the Placement Shares.

For the purposes of ASX Listing Rule 7.5, the following information is provided:

- a) Placement Shares have been issued to unrelated professional, sophisticated or other investors that fall within one or more of the classes of exemptions specified in section 708 of the Corporations Act identified by the Company, Bell Potter Securities and Ord Minnett Limited. No Placement shares were issued to Key Management Personnel, a substantial holder of the Company, or an adviser to the Company or any associates thereof.
- b) 100,000,004 fully paid ordinary Shares were issued under the Placement on 8 November 2024 at an issue price of \$0.055 per Share and rank equally with all other existing Shares.
- c) A further issue 10,000,000 fully paid ordinary shares were issued under the Placement on 15 November 2024 at an issue price of \$0.055 per Share and rank equally with all other existing Shares.
- d) The Placement Shares were issued to enable the Company to execute on its Horizon 2 and Horizon 3 strategy, including exploration at the Red Mountain Copper-Gold Project and Sant Tolgoi Nickel-Copper Project, new project acquisition and exploration, 12 months general and administrative costs, general working capital and Khuiten Metals Joint Venture Q1 CY2025 costs.
- e) The Placement Shares were issued pursuant to Xanadu Mines' 15% placement capacity in accordance with ASX Listing Rule 7.1.
- f) A Voting Exclusion Statement accompanies Resolution 2 in the Notice of Meeting.

**Director Recommendations**

The Directors unanimously recommend Shareholders vote in favour of Resolution 2.

For personal use only

## Definitions

**25% Put Option** means the put option to require Zijin to acquire from Xanadu a further 25% interest in Khuiten for a payment to the Company of US\$25,000,000.

**ASX** means ASX Limited ACN 008 624 691 or the Australian Securities Exchange (as applicable).

**Board** means the board of directors of the Company.

**Chair** means the person who chairs the Meeting.

**Company** means Xanadu Mines Limited ACN 114 249 026.

**Constitution** means the constitution of the Company from time to time.

**Corporations Act** means the *Corporations Act 2001* (Cth) as amended, varied or replaced from time to time.

**Director** means a director of the Company.

**Explanatory Memorandum** means this explanatory memorandum accompanying the Notice of Meeting.

**Funding Loan** means the proposed loan from Zijin to the Company in respect of funding requirements at the Kharmagtai Project, as set out in Schedule 1.

**Independent Expert** means BDO Corporate Finance Ltd ABN 54 010 185 725, Australian Financial Services Licence No. 245513.

**Independent Expert's Report** means the report prepared by the Independent Expert and attached at Schedule 2, stating the Independent Expert's opinion as to whether the Proposed Transaction is fair and reasonable.

**JV Shareholders' Agreement** means the joint venture shareholders' agreement dated 21 December 2022 between the Company and Zijin in respect of the joint venture in Khuiten Metals Pte Ltd.

**Kharmagtai Project** means the Kharmagtai Copper-Gold Project.

**Khuiten Metals** means Khuiten Metals Pte Ltd.

**Meeting, Extraordinary General Meeting or EGM** means the extraordinary general meeting to be held at Royal Automotive Club of Victoria, Level 1, 501 Bourke Street, Melbourne Victoria 3000 on Thursday, 10 April 2025 as convened by the accompanying Notice of Meeting.

**Non-Associated Shareholder** means a Shareholder who is not Jinping (Singapore) Mining Pte. Ltd or its associated entities.

**Notice of Meeting or Notice** means the notice of meeting giving notice to Shareholders of the Meeting, accompanying this Explanatory Memorandum.

**Ordinary Resolution** means a resolution passed by more than 50% of the votes cast at a general meeting of shareholders.

**Proposed Transaction** means the Company:

- (a) exercising the 25% Put Option; and
- (b) entering into the Funding Loan.

**Resolution** means a resolution as set out in the Notice of Meeting.

**Security** means the security interest granted by Xanadu to Zijin under the Funding Loan, being Xanadu's remaining interest in Khuiten Metals.

**Share** means an ordinary fully paid share in the issued capital of the Company.

**Shareholder** means a holder of Shares in the Company.

**Zijin** means Zijin Mining Group Co. Ltd.

For personal use only

## Schedule 1 – Summary of Joint Venture Shareholders' Agreement and Funding Loan

### Joint Venture Shareholders' Agreement

The key terms of the joint venture agreement between the Company and Zijin are as follows:

1. commencement from the date of completion of the subscription agreement for the Phase 3 JV;
2. the primary objective for Xanadu to use reasonable endeavours to deliver a PFS for the Kharmagtai Project within 18 months from commencement of the joint venture;
3. funding to be paid from the payment made by Zijin to subscribe for its 50% interest and thereafter to be borne by shareholders in their respective proportions. Where a party fails to meet its funding obligations, the other party will be entitled to meet that shortfall in return for the issue of additional shares (resulting in the dilution of the defaulting shareholder);
4. agreement on an initial development plan and budget for the first 18 months from commencement of the Joint Venture Agreement (which is expected to take the joint venture through to delivery of the PFS). After that, approval of annual budgets and development plans will require unanimous approval of the board of Khuiten;
5. appointment of Xanadu in the role of the operator of the joint venture from commencement until the earlier of delivery of the PFS or 18 months from commencement of the preparation of the PFS, after which Zijin will assume the role of operator unless otherwise agreed by shareholders;
6. the initial appointment of two directors from each of Xanadu and Zijin to the board of Khuiten (one for each 25% interest held);
7. a right for Xanadu to appoint the initial chairperson of the Khuiten board through until the earlier of delivery of the PFS or 18 months from commencement of the preparation of the PFS. Xanadu's Executive Chairman and Managing Director, Colin Moorhead, will be the initial appointee as chairperson. Zijin will have the right to appoint the chairperson after that initial period has lapsed;
8. a right for Xanadu to appoint the initial General Manager for Khuiten through until the earlier of delivery of the PFS or 18 months from commencement of the preparation of the PFS, with the Deputy General Manager to be appointed by Zijin. After that initial period has elapsed, these rights will reverse (provided that Xanadu must retain at least a 25% interest to preserve its right to appoint the Deputy General Manager);
9. equal voting rights from commencement for Xanadu and Zijin at Khuiten board meetings (voting rights based upon respective proportionate shareholdings), with the chairperson not having a casting vote;
10. identified critical business matters, including certain expenditure or transactions with a value above US\$1,000,000, increasing to US\$10,000,000 after the earlier of delivery of the PFS or 18 months from commencement of the preparation of the PFS, will require a special majority approval by the board of Khuiten (being greater than 67% of votes which may be cast);
11. deadlocks at a board or shareholder meeting for Khuiten, the following process will be instigated:
  - (a) the conduct of a further meeting as soon as possible to consider the same resolution;
  - (b) where there is a continuing deadlock, negotiations must be conducted between the senior representatives of Xanadu and Zijin to resolve the dispute;
  - (c) where the deadlock continues and relates to technical or accounting matters, then the dispute is to be referred to an appropriately qualified independent expert as appointed by the board;
  - (d) if a deadlock is unable to be resolved, the board will be taken to have determined that no action is to be taken on that resolution;
12. the grant of the two put options to Xanadu to require Zijin to acquire from Xanadu either a further 25% interest in Khuiten (**25% Option**) or the whole of Xanadu's 50% interest in Khuiten (**50% Option**). The key terms relating to the exercise of these options are:
  - (a) purchase price payable by Zijin is US\$25,000,000 for the 25% Option and US\$50,000,000 for the 50% Option;

For personal use only



- (b) the right to exercise either put option only arises if Xanadu delivers the PFS for the Kharmagtai Project. This PFS:
- (1) must constitute a comprehensive prefeasibility study of the viability of the Kharmagtai Project including:
    - (A) a comparison of options and selecting a single path forward for mining method, processing and infrastructure; and
    - (B) a financial analysis based on reasonable assumptions of technical, engineering, operating, economic factors and the evaluation of other relevant factors which are sufficient for a qualified person, acting reasonably, to determine if all or part of the mineral resource may be classified as a mineral reserve under the JORC Code, 2012 or NI 43-101;
  - (c) must support a JORC Code, 2012 compliant Ore Reserve or NI43-101 compliant Mineral Reserve:
    - (1) with a life of mine of at least 20 years (using economic input parameters consistent with the Scoping Study dated 6 April 2022 and the NI43-101 Preliminary Economic Assessment Technical Report dated 20 June 2022);
    - (2) with an internal rate of return of at least 20%; and
    - (3) a payback period of less than 6 years.
  - (d) once the PFS is delivered, Xanadu will have a 6 month period to exercise either option, including first obtaining any shareholder, ASX, TSX or other regulatory approvals which may be necessary as a precondition to Xanadu being able to exercise the relevant option;
  - (e) completion will take place two months after the exercise of an option by Xanadu; and
  - (f) Xanadu will only be able to exercise either one of these options (ie. the 50% Option will lapse if the 25% Option is exercised);
13. if Xanadu exercises the 25% Option, it will remain liable for its respective proportion of the funding for the progression of the joint venture until commencement of commercial production at the Kharmagtai Project. This would be funded by way of a loan from Zijin (**Funding Loan**), the terms of which are summarised further below.
14. pre-emptive rights for the issue of additional shares in Khuiten, such that new shares will be first offered to all shareholders in their respective proportions. Additional shares which have not been accepted by a shareholder will then be offered to the other shareholders. Any additional shares which have still not been accepted can then be offered to third parties (at no lower issue price);
15. pre-emptive rights for the acquisition of shares held in Khuiten proposed to be disposed of by a shareholder to a third party. Notice and details of the proposed sale must be provided to the other shareholders and be open for acceptance, in their respective proportions, for 20 business days. Offers not initially accepted by a shareholder must be offered to other shareholders. Remaining unsold shares can be sold to a third party within 3 months after this process on terms no more advantageous than those offered to the shareholders; and
16. drag along and tag along rights apply to a proposed sale of shares held in Khuiten by either a single shareholder holding at least 51% or multiple shareholders holding at least 75% in aggregate – on terms the same as (drag right) or no less favourable than (tag rights) the terms on which the seller proposes to sell its shares to a proposed purchaser.

## Funding Loan

The key terms of the Funding Loan between the Company and Zijin are as follows:

<b>Borrower:</b>	Xanadu Mines Ltd (ACN 114 249 026)
<b>Lender:</b>	Jinping (Singapore) Mining Pte. Ltd. ( <b>Jinping</b> ) or an affiliate of Jinping
<b>Facility Description:</b>	Loan Facility (the <b>Loan</b> )
<b>Facility Limit:</b>	Up to Xanadu's Respective Proportion of all funding amounts required under clause <b>11.1(b)(2)</b> of the JV Shareholders' Agreement until commencement of commercial production at the Kharmagtai Project.
<b>Mandatory Prepayments:</b>	Until the Loan is repaid in full, 90% of all amounts that the Borrower is entitled to receive from the Company by way of loan repayment, interest payment, dividends, capital reduction and any other forms of distributions must be applied in repayment of the Loan. The Borrower will be entitled to receive and retain 10% of such payments from the Company for its own use.
<b>Repayment Date:</b>	All amounts owing under the Loan are due and payable by the Borrower by the earlier of: <ul style="list-style-type: none"> <li>(a) 10 years from the date of the commencement of the commercial production of the Kharmagtai Project;</li> <li>(b) immediately upon termination of the JV Shareholders' Agreement; and</li> <li>(c) immediately after a written demand is provided to the Borrower by the Lender if an Event of Default by the Borrower occurs.</li> </ul> <p>The Borrower may elect to prepay amounts drawn down under the Loan at any time prior to the repayment date by the provision of 5 Business Days' notice.</p>
<b>Interest Rate:</b>	SOFR (based on a 6 month term) + 5%.
<b>Interest Period:</b>	Capitalised monthly and payable on the Repayment Date
<b>Default Rate:</b>	3% on top of the Interest Rate.
<b>Purpose:</b>	The proceeds of the Loan will only be used by the Borrower to meet the Borrower's Respective Proportion of the Company Costs pursuant to clause 11.1(b)(2) of the JV Shareholders' Agreement. The Loan will be advanced by the Lender directly to the bank account of the Company or bank account nominated by the Company.
<b>Conditions to drawdown:</b>	Subject to usual draw down conditions, such as: <ul style="list-style-type: none"> <li>- receipt of a drawdown notice that specifies (i) the amount required; (ii) the date that the drawdown is required (which must be a Business Day and must be at least 5 Business Days after the date of the draw down notice) and must certify that the representations provided by the Borrower remain true and correct at the date of the notice and as at the date the drawdown amount is to be provided;</li> <li>- the amount the subject of the drawdown notice cannot result in the Facility Limit being exceeded;</li> <li>- the Lender being satisfied that no Event of Default has occurred; and</li> <li>- any other information or documentation which the Lender reasonably requests in connection with the drawdown.</li> </ul>

For personal use only

---

<b>Security:</b>	Xanadu's entire shareholding in Khuiten to be pledged to Zijin.
<b>Representations and warranties:</b>	Customary representations and warranties for a loan facility of similar nature (power and capacity, corporate authorisations, no legal impediment, corporate status and solvency etc).
<b>Undertakings</b>	Customary undertakings to be provided by the Borrower.
<b>Events of Default:</b>	Customary events of default including but not limited to: <ul style="list-style-type: none"><li>- Non-payment if the Borrower fails to remedy to the reasonable satisfaction of the Lender within 10 Business Days of being provided with notice by the Lender;</li><li>- Change of control of Xanadu;</li><li>- Insolvency of the Borrower;</li><li>- Cessation of business;</li><li>- Breach of representation provided by the Borrower in any material respect which, if remediable, the Borrower fails to remedy to the reasonable satisfaction of the Lender within 20 Business Days of being provided with notice by the Lender or the Borrower becoming aware of the breach (whichever is the earlier); and</li><li>- Breach of obligation in the Loan Facility which, if remediable the Borrower fails to remedy to the reasonable satisfaction of the Lender within 20 Business Days of being provided with notice by the Lender or the Borrower becoming aware of the breach (whichever is the earlier).</li></ul>
<b>Governing law:</b>	Singapore

---

For personal use only

**Schedule 2 – Independent Expert’s Report**

For personal use only

# Xanadu Mines Ltd

Independent Expert's Report

Opinion: The Proposed Transaction is Fair and Reasonable

11 March 2025

For personal use only

## FINANCIAL SERVICES GUIDE

Dated: 11 March 2025

The Financial Services Guide ('FSG') is provided to comply with the legal requirements imposed by the Corporations Act 2001 and includes important information regarding the general financial product advice contained in this report ('this Report'). The FSG also includes general information about BDO Corporate Finance Ltd ABN 54 010 185 725, Australian Financial Services Licence No. 245513 ('BDOCF' or 'we', 'us' or 'our'), including the financial services we are authorised to provide, our remuneration and our dispute resolution.

BDOCF holds an Australian Financial Services Licence to provide the following services:

- a) Financial product advice in relation to deposit and payment products (limited to basic deposit products and deposit products other than basic deposit products), securities, and interests in managed investment schemes excluding investor directed portfolio services;
- b) Arranging to deal in financial products in relation to securities; and
- c) Applying for, acquiring, varying or disposing of a financial product in relation to interests in managed investment schemes excluding investor directed portfolio services, and securities.

### *General Financial Product Advice*

This Report sets out what is described as general financial product advice. This Report does not consider personal objectives, individual financial position or needs and therefore does not represent personal financial product advice. Consequently, any person using this Report must consider their own objectives, financial situation and needs. They may wish to obtain professional advice to assist in this assessment.

### *The Assignment*

BDOCF has been engaged to provide general financial product advice in the form of a report in relation to a financial product. Specifically, BDOCF has been engaged to provide an independent expert's report to the Non-Associated Shareholders of Xanadu Mines Ltd ('Xanadu' or 'the Company') in relation to the potential execution of a put option ('the Proposed Transaction').

Further details of the Proposed Transaction are set out in Section 4. The scope of this Report is set out in detail in Section 3.3. This Report provides an opinion on whether or not the Proposed Transaction is 'fair and reasonable' to the non-associated shareholders of Xanadu ('Non-Associated Shareholders') and has been prepared to provide information to the Non-Associated Shareholders to assist them to make an informed decision on whether to vote in favour of or against the Proposed Transaction. Other important information relating to this Report is set out in more detail in Section 3.

This Report cannot be relied upon for any purpose other than the purpose mentioned above and cannot be relied upon by any person or entity other than those mentioned above, unless we have provided our express consent in writing to do so. A shareholder's decision to vote in favour of or against the Proposed Transaction is likely to be influenced by their particular circumstances, for example, their taxation considerations and risk profile. Each shareholder should obtain their own professional advice in relation to their own circumstances.

### *Fees, Commissions and Other Benefits we may Receive*

We charge a fee for providing reports. The fees are negotiated with the party who engages us to provide a report. We estimate the fee for the preparation of this Report will be approximately \$147,500 plus GST. Fees are usually charged as a fixed amount or on an hourly basis depending on the terms of the agreement with the engaging party. Our fees for this Report are not contingent on the outcome of the Proposed Transaction.

Except for the fees referred to above, neither BDOCF, nor any of its directors, employees or related entities, receive any pecuniary benefit or other benefit, directly or indirectly, for or in connection with the provision of this Report.

Directors of BDOCF may receive a share in the profits of BDO Group Holdings Limited, a parent entity of BDOCF. All directors and employees of BDO Group Holdings Limited and its subsidiaries (including BDOCF) are entitled to receive a salary. Where a director of BDOCF is a shareholder of BDO Group Holdings Limited, the person is entitled to share in the profits of BDO Group Holdings Limited.

### *Associations and relationships*

From time to time BDOCF or its related entities may provide professional services to issuers of financial products in the ordinary course of its business. These services may include audit, tax and business advisory services. While BDOCF has not provided any professional services to Xanadu in the last two years, we note that related entities have provided professional services including BDO Corporate Finance (WA) Pty Ltd providing option valuations services to Xanadu.

The signatories to this Report do not hold any shares in Xanadu and no such shares have ever been held by the signatories.

To prepare our reports, including this Report, we may use researched information provided by research facilities to which we subscribe or which are publicly available. Reference has been made to the sources of information in this Report, where applicable. Research fees are not included in the fee details provided in this Report.

## Complaints Resolution

### Internal Complaints Resolution Process

We are committed to meeting your needs and maintaining a high level of client satisfaction. If you are unsatisfied with a service we have provided you, we have avenues available to you for the investigation and resolution of any complaint you may have.

To make a formal complaint, please use the Complaints Form. For more on this, including the Complaints Form and contact details, see the [BDO Complaints Policy](#) available on our website.

### Referral to External Dispute Resolution Scheme

BDOCF is a member of Australian Financial Complaints Authority ('AFCA') (Member Number 10236).

Where you are unsatisfied with the resolution reached through our Internal Dispute Resolution process, you may escalate this complaint to the AFCA using the contact details set out below.

Australian Financial Complaints Authority Limited  
Mail: GPO Box 3, Melbourne VIC 3001  
Online Address: <http://www.afca.org.au>  
Email: [info@afca.org](mailto:info@afca.org)  
Phone: 1800 931 678  
Fax: (03) 9613 6399  
Interpreter Service: 131 450

### Compensation Arrangements

BDOCF and its related entities hold Professional Indemnity insurance for the purpose of compensating retail clients for loss or damage suffered because of breaches of relevant obligations by BDOCF or its representatives under Chapter 7 of the Corporations Act 2001. These arrangements and the level of cover held by BDOCF satisfy the requirements of section 912B of the Corporations Act 2001.

### Contact Details

BDO Corporate Finance Ltd

Location Address:	Postal Address:
Level 10 12 Creek Street BRISBANE QLD 4000	GPO Box 457 BRISBANE QLD 4001
Phone: (07) 3237 5999	Email: <a href="mailto:cf.brisbane@bdo.com.au">cf.brisbane@bdo.com.au</a>
Fax: (07) 3221 9227	

# CONTENTS

Financial Services Guide	i
<b>PART I: ASSESSMENT OF THE PROPOSED TRANSACTION</b>	<b>1</b>
<b>1.0 Introduction</b>	<b>1</b>
<b>2.0 Assessment of the Proposed Transaction</b>	<b>2</b>
2.1 Basis of evaluation	2
2.2 Assessment of fairness	2
2.3 Assessment of reasonableness	5
2.4 Opinion	8
<b>3.0 Important information</b>	<b>9</b>
3.1 Read this Report, and other documentation, in full	9
3.2 Non-Associated Shareholders' individual circumstances	9
3.3 Scope	9
3.4 Purpose of this Report	10
3.5 Current market conditions	10
3.6 Reliance on information	11
3.7 Glossary	11
3.8 Sources of information	11
3.9 APES 225 Valuation Services	12
3.10 Forecast information	12
3.11 Qualifications	12
<b>PART II: INFORMATION SUPPORTING OUR OPINION ON THE PROPOSED TRANSACTION</b>	<b>13</b>
<b>4.0 Overview of the Proposed Transaction</b>	<b>13</b>
4.1 Background of the Proposed Transaction	13
4.2 Summary of the Proposed Transaction	14
<b>5.0 Background of Xanadu</b>	<b>18</b>
5.1 Background and key projects	18
5.2 Equity structure of Xanadu	23
5.3 Share trading data of Xanadu	24
5.4 Historical financial information of Xanadu	26
<b>6.0 Industry Overview</b>	<b>32</b>
6.1 Copper	32
6.2 Gold	35
<b>7.0 Common Valuation Methodologies</b>	<b>38</b>
7.1 Overview	38
7.2 Basis of value	38
7.3 Income approach	38
7.4 Market approach	38
7.5 Cost based method	39
<b>8.0 Valuation of Xanadu's Interest in the Khuiten JV prior to the Proposed Transaction</b>	<b>40</b>
8.1 Our valuation approach in relation to Xanadu's interest in the Khuiten JV prior to the Proposed Transaction	40
8.2 Overview of ERM's technical expert report ('ERM Report')	41
8.3 Cashflow assumptions in relation to the Kharmagtai Project	41
8.4 Conversion of Kharmagtai Project cash flows to Xanadu's cashflows	47
8.5 Value of the Khuiten JV cash flows to Xanadu	49
8.6 Value of Xanadu's Interest in the Khuiten JV	51
8.7 Consideration of the share transaction valuation methodology	54
<b>9.0 Valuation of Xanadu's interest in the Khuiten JV Post the Proposed Transaction</b>	<b>59</b>
9.1 Conversion of the Kharmagtai Project cashflows to Xanadu's cashflows	59
9.2 Value of the Khuiten JV cashflows to Xanadu	60



9.3	Value of Xanadu's interest in the Khuiten JV	61
9.4	Adjustment to enable like-for-like comparison	62

<b>Appendix A:</b>	<b>Glossary</b>	<b>64</b>
--------------------	-----------------	-----------

<b>Appendix B:</b>	<b>Independent Technical Expert's Report - ERM Report</b>	<b>67</b>
--------------------	---	-----------

---

For personal use only

## PART I: ASSESSMENT OF THE PROPOSED TRANSACTION

The Non-Associated Shareholders  
C/- The Non-Associated Directors  
Xanadu Mines Limited  
Level 12, 680 George Street  
Sydney, New South Wales, Australia, 2000

11 March 2025

Dear Non-Associated Shareholders,

### 1.0 Introduction

BDO Corporate Finance Ltd ('BDOCF', 'we', 'us' or 'our') has been engaged to provide an independent expert's report ('this Report') to the non-associated shareholders ('the Non-Associated Shareholders') of Xanadu Mines Limited ('Xanadu or 'the Company') in relation to a put option related to the Kharmagtai copper gold project ('the Kharmagtai Project').

The exercise of this put option, granted to Xanadu by Jinping (Singapore) Mining Pte. Ltd. ('Jinping'), a wholly owned subsidiary of Zijin Mining Group Co. Ltd ('Zijin') and hence referred to as Zijin, will require Zijin to purchase 50% of all shares owned by Xanadu in the Khuiten Metals Pte Ltd ('Khuiten') joint venture ('JV') ('the Khuiten JV') in exchange for 25 million United States dollars ('US\$') and Zijin agreeing to pay Xanadu's portion of all funding amounts required on behalf of Xanadu until commencement of commercial production at the Kharmagtai Project ('the Proposed Transaction'). Xanadu's portion of all funding amounts funded by Zijin will constitute an interest-bearing loan to be repaid in full via 90% of all dividends and distributions due and payable by the Khuiten JV to Xanadu on Xanadu's shares.

A more detailed description of Proposed Transaction is set out in Section 4.

In this Report, BDOCF has expressed an opinion as to whether or not Proposed Transaction is 'fair and reasonable' to the Non-Associated Shareholders.

This Report has been prepared solely for use by the Non-Associated Shareholders to provide them with information relating to the Proposed Transaction. The scope and purpose of this Report are detailed in Sections 3.3 and 3.4 respectively.

This Report, including Part I, Part II and the appendices, should be read in full along with all other documentation provided to the Non-Associated Shareholders including the Notice of Meeting and Explanatory Memorandum dated 11 March 2025 prepared by Xanadu ('the Notice of Meeting') in relation to the general meeting to be held on 10 April 2025 ('the Meeting').

## 2.0 Assessment of the Proposed Transaction

This section is set out as follows:

- ▶ Section 2.1 sets out the methodology for our assessment of the Proposed Transaction;
- ▶ Section 2.2 sets out our assessment of the fairness of the Proposed Transaction;
- ▶ Section 2.3 sets out our assessment of the reasonableness of the Proposed Transaction; and
- ▶ Section 2.4 provides our assessment of whether the Proposed Transaction is fair and reasonable to the Non-Associated Shareholders.

### 2.1 Basis of evaluation

This Report has been prepared for the purpose of meeting certain requirements of the ASX Listing Rules (refer to Section 3.4 below).

The ASX Listing Rules do not provide guidance in relation to the definition of 'fair and reasonable'. In determining whether the Proposed Transaction is considered fair and reasonable we have had regard to the guidance provided by RG 111 and RG 76. RG 111 provides guidance as to what matters an independent expert should consider to assist security holders to make an informed decision about transactions.

RG 111 suggests that where an expert is to assess whether a related party transaction is 'fair and reasonable' for the purpose of complying with ASX Listing Rule 10.1, the assessment should not be applied as a composite test. That is, the expert should assess separately whether the transaction is 'fair' and 'reasonable'. The expert's report should explain how the particulars of the transaction were evaluated as well as the results of the examination and evaluation.

We have assessed the fairness and reasonableness of the Proposed Transaction in Sections 2.2 and 2.3 below and concluded on our opinion of the Proposed Transaction in Section 4.4 below.

### 2.2 Assessment of fairness

#### 2.2.1 Basis of assessment

RG 111 states that a related party offer is fair if the value of the financial benefit provided by the entity to the related party is equal to or less than the value of the consideration received. In this case, the financial benefit provided by Xanadu is a 25% interest in the Khuiten JV, while the consideration received is US\$25 million.

Simplistically, this would suggest that the Proposed Transaction is fair if the value of a 25% interest in the Khuiten JV is equal to or less than US\$25 million. However, this simplistic comparison does not fully capture the economic substance of the transaction, as Xanadu's remaining 25% interest in the Khuiten JV will fundamentally change post-transaction.

Under the current structure, Xanadu is required to fund its share of development costs. Following the Proposed Transaction, Xanadu will be loan-carried, meaning it will not contribute capital, but will only begin receiving the majority of cash flows after Zijin has recovered the carried funding<sup>1</sup>. This shift fundamentally changes the cash flow profile of Xanadu's remaining interest, and a direct percentage-based comparison is not appropriate in our view.

To overcome this deficiency, in our view, the fairness assessment requires two comparisons:

- 1) Total value comparison: This assesses whether the value of Xanadu's current 50% interest in the Khuiten JV is at least equal to the combined value of its post-transaction 25% interest (no longer subject to funding risk) plus US\$25 million. If this holds true, then the Proposed Transaction is fair to Xanadu's Non-Associated Shareholders; and
- 2) Consideration vs value reduction comparison: This assesses whether the US\$25 million consideration is at least equal to the reduction in value when Xanadu's current 50% interest in the Khuiten JV reduces to 25% post-transaction. If this holds true, then the Proposed Transaction is fair to Xanadu Non-Associated Shareholders.

By considering both comparisons, we ensure that the fairness assessment captures the structural change in Xanadu's cash flows rather than simply comparing ownership percentages with consideration received.

#### 2.2.2 Value of a Xanadu's interest in the Khuiten JV

To value Xanadu's interest in the Khuiten JV, we considered a summation methodology that comprised:

- ▶ A discounted cash flow ('DCF') valuation methodology to determine the present value of Xanadu's share of future cash flows from the Khuiten JV;
- ▶ Adjustments for other assets and liabilities held by the Khuiten JV; and
- ▶ Consideration of discounts for lack of control, lack of marketability, and funding and dilution risk.

<sup>1</sup> Per the option agreement, Zijin will finance the portion of capital development attributable to Xanadu's 25% ownership of the Khuiten JV. Zijin will then receive 90% of Xanadu's portion of cash flows from the Khuiten JV until such a time as the financed capital is paid back to Zijin, including interest.

While the underlying cash flow profiles differ pre and post the Proposed Transaction, the summation approach more generally was consistent both pre and post the Proposed Transaction. Our value of the Khuiten JV prior to the Proposed Transaction is set out in Section 8.6.5 and our valuation of the Khuiten JV post the Proposed Transaction is set out in Section 9.3.4. We also cross-checked the value derived from the summation method prior to the Proposed Transaction with reference to the implied value of the Khuiten JV from recent trading in Xanadu's shares.

In forming a view on the cash flow profile to be received by the Khuiten JV from the Kharmagtai Project, we have relied on the work of ERM International Group Limited ('ERM') who we engaged to assess the reasonableness of each of the assumptions used in the cash flow model provided by Xanadu in relation to the Kharmagtai Project, including:

- ▶ The resources and reserves incorporated into the cash flows model, and the treatment of any residual resource post the assumed mine life;
- ▶ The mining physicals including the tonnes of ore mined, quality, waste material, and mine life;
- ▶ The processing physicals including the ore processed and produced;
- ▶ The production and operating costs including but not limited to drilling, blasting, mining, haulage, processing, transport, general administration, distribution and marketing, contingencies and royalties or levies;
- ▶ The capital expenditure ('CAPEX') including but not limited to pre-production costs, project capital costs, sustaining capital expenditure, salvage value, rehabilitation, and contingency; and
- ▶ Any other relevant technical assumptions not specified above.

The ERM Independent Technical Specialists Report dated 11 March 2025 ('the ERM Report') is attached as Appendix B to this Report. While ERM has provided us with information which indicates they have the requisite experience to assess the inputs into the cash flow model provided by Xanadu and complete a valuation of Xanadu's other tenements, we are not responsible for the ERM Report.

### 2.2.3 Comparison 1 - Total value

In Table 2.1 below we have set out a comparison of Xanadu's current 50% interest in the Khuiten JV to the combined value of Xanadu's post-transaction 25% interest (no longer exposed to funding risk) plus the US\$25 million consideration received. This ensures a like-for-like comparison, accounting for both the ownership reduction and the structural change in future cash flows.

**Table 2.1: Comparison of Xanadu's value in the Khuiten JV prior and post the Proposed Transaction**

US\$m	Reference	Low	High
Xanadu's interest in the Khuiten JV prior to the Proposed Transaction	Section 8.6.5	59.3	108.0
<b>Total value of Xanadu's interest in the Khuiten JV prior the Proposed Transaction</b>		<b>59.3</b>	<b>108.0</b>
Xanadu's interest in Khuiten JV post the Proposed Transaction	Section 9.3.4	54.1	80.9
Cash proceeds		25.0	25.0
<b>Total value of Xanadu's interest in the Khuiten JV post the Proposed Transaction</b>		<b>79.1</b>	<b>105.9</b>

Source: BDOCF analysis

In Figure 2.1 below we have set out a graphical comparison.

**Figure 2.1: Graphical comparison of Xanadu's value in Khuiten JV prior and post the Proposed Transaction**

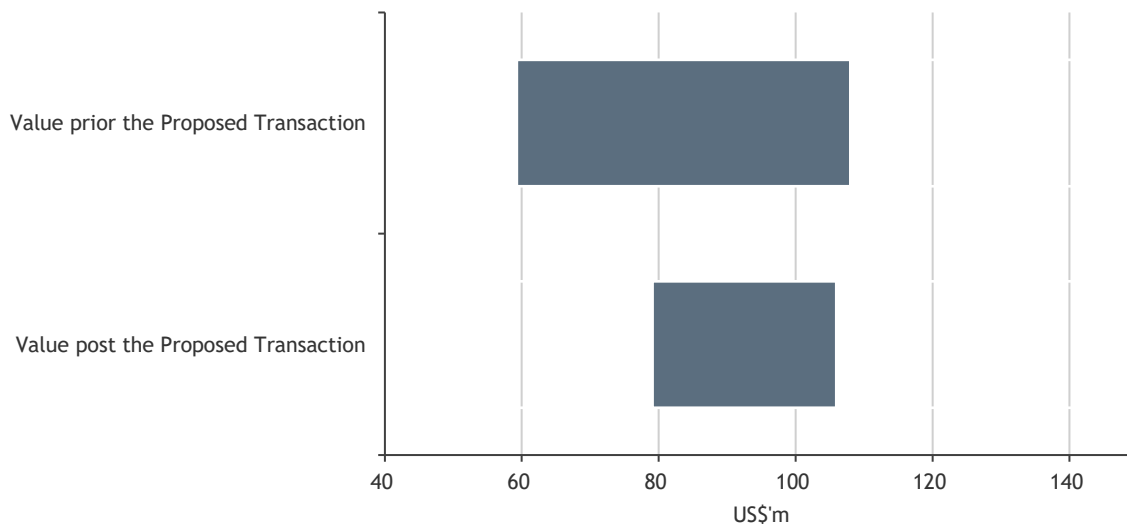

Source: BDOCF analysis

In relation to Table 2.1 and Figure 2.1 above we note:

- ▶ The post valuation range has tightened reflecting:
  - US\$25 million portion of the value is fixed to the cash proceeds Xanadu would receive from the Proposed Transaction;
  - The structural change in Xanadu’s cash flows given Xanadu is no longer required to source funding for the Khuiten JV’s construction costs; and
  - The reduction in funding and dilution risk at the Xanadu corporate level.
- ▶ The post valuation range largely overlaps with the top half of the pre valuation. In considering this point we note that we have applied a discount for funding and dilution risk at the Xanadu corporate level prior to the Proposed Transaction. We have removed this discount post the Proposed Transaction as, if the Put Option is exercised, Xanadu will have the benefit of relying on Zijin funding.

In our view, based on the above analysis, the sum of Xanadu’s value in the Khuiten JV post the Proposed Transaction plus US\$25 million is equal to or greater than Xanadu’s interest in the Khuiten JV prior the Proposed Transaction.

#### 2.2.4 Comparison 2 - Consideration vs value reduction

In Table 2.2 below, we compare the US\$25 million consideration received to the reduction in value from Xanadu’s interest in the Khuiten JV reducing from 50% to 25% as a result of the Proposed Transaction (which, as discussed previously, is not as simple as changing the proportionate interest as the underlying cash flow profile and risks to Xanadu change post the Proposed Transaction). This ensures that the consideration appropriately compensates for the decrease in Xanadu’s ownership, while also accounting for the structural change in cash flows due to the reduction in funding risk post Proposed Transaction. .

**Table 2.2: Comparison of Xanadu’s value in Khuiten JV prior and post the Proposed Transaction**

US\$m	Reference	Low	High
Xanadu’s interest in the Khuiten JV prior the Proposed Transaction	Section 8.6.5	59.3	108.0
Xanadu’s interest in the Khuiten JV post the Proposed Transaction	Section 9.3.4	54.1	80.9
<b>Reduction in Xanadu’s Khuiten JV value due to the Proposed Transaction</b>		<b>5.2</b>	<b>27.1</b>
<b>Cash proceeds</b>		<b>25.0</b>	<b>25.0</b>

Source: BDOCF analysis

In Figure 2.2 below, we present a graphical comparison of the consideration received versus the reduction in Xanadu’s interest in the Khuiten JV.

**Figure 2.2: Graphical comparison of Xanadu’s Khuiten JV value reduction vs consideration**

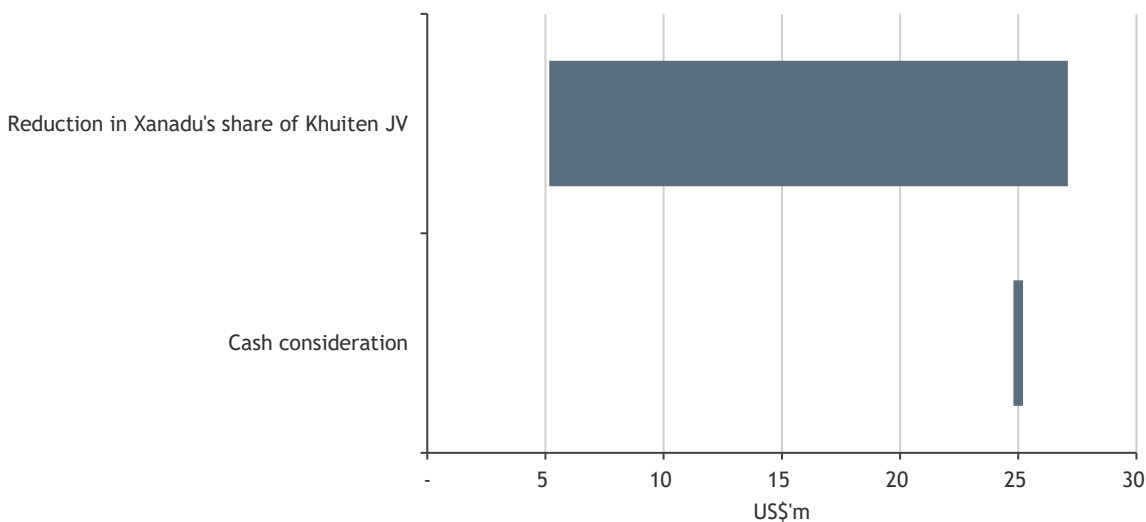

Source: BDOCF analysis

In relation to Table 2.2 and Figure 2.2 above we note the reduction in Xanadu’s JV interest value is between US\$2.6 million and US\$27.1 million. This range is broadly less than the US\$25 million consideration being received, albeit with a slight overlap at the higher end.

In our view, based on the above analysis, the value of the consideration to be received by Xanadu is broadly equal to or greater than the value reduction in Xanadu’s interest in the Khuiten JV.

### 2.2.5 Assessment of the fairness of the Proposed Transaction

RG 111 states that a related party offer is fair if the value of the financial benefit provided by Xanadu to Zijin is equal to or less than the value of the consideration received. Based on the comparisons set out in Sections 2.2.3 and 2.2.4 above, we consider that the financial benefit provided by Xanadu to Zijin is equal to or less than the value of the consideration received.

After considering the information summarised above and set out in detail in the balance of this Report, it is our view that, in the absence of any other information, the Proposed Transaction is **Fair** to the Non-Associated Shareholders as at the date of this Report.

## 2.3 Assessment of reasonableness

### 2.3.1 Basis of assessment

Under RG 111, a transaction is considered reasonable if it is fair. It may also be reasonable, despite not being fair, if after considering other significant factors the interests of the Non-Associated Shareholders are reasonably balanced.

In addition to our fairness assessment set out in Section 2.2 above, to assess whether the Proposed Transaction is 'reasonable' we consider it appropriate to examine other significant factors to which the Non-Associated Shareholders may give consideration prior to forming a view on whether to vote in favour of or against the Proposed Transaction. This includes comparing the likely advantages and disadvantages of approving the Proposed Transaction with the position of a Non-Associated Shareholder if the Proposed Transaction is not approved, as well as a consideration of other significant factors.

Our assessment of the reasonableness of the Proposed Transaction is set out as follows:

- ▶ Section 2.3.2 sets out the advantages of the Proposed Transaction to the Non-Associated Shareholders;
- ▶ Section 2.3.3 sets out the disadvantages of the Proposed Transaction to the Non-Associated Shareholders;
- ▶ Section 2.3.4 sets out a discussion of other considerations relevant to the Proposed Transaction;
- ▶ Section 2.3.5 sets out the position of the Non-Associated Shareholders if the Proposed Transaction is not approved; and
- ▶ Section 2.3.6 provides our opinion on the reasonableness of Proposed Transaction to the Non-Associated Shareholders.

### 2.3.2 Advantages of the Proposed Transaction

Table 2.2 below outlines the potential advantages to the Non-Associated Shareholders of approving the Proposed Transaction.

**Table 2.2: Potential advantages of the Proposed Transaction**

Advantage	Explanation
The Proposed Transaction is Fair	In our view, the Proposed Transaction is Fair to the Non-Associated Shareholders as at the date of this Report. In accordance with RG111, a transaction is considered reasonable if it is fair. Refer to Section 2.2 of this Report for our assessment of fairness of the Proposed Transaction.
Immediate value realisation without fully exiting the Kharmagtai Project	The Proposed Transaction provides immediate and certain value to Xanadu's Non-Associated Shareholders through a US\$25 million upfront cash payment. This allows Xanadu to monetise a portion of Xanadu's interest in the Kharmagtai Project while still retaining exposure to future value creation.
De-risked project exposure without further dilution	Xanadu's remaining 25% interest in the Khuiten JV is fully funded by Zijin through the Kharmagatai Project's development phase, eliminating the need for Xanadu to contribute additional capital at this stage.  Without the Proposed Transaction, Xanadu may be required to complete significant equity raisings which would dilute an existing Xanadu Non-Associated Shareholders' interest if they did not participate. The Proposed Transaction's structure allows Non-Associated Shareholders to maintain their proportional interest in Xanadu while benefiting from the asset's continued advancement.
Retained exposure to future upside	The Proposed Transaction allows Xanadu to maintain a 25% interest in the Khuiten JV, allowing Non-Associated Shareholders continue to participate in the Kharmagtai Project's long-term prospects. If the Kharmagtai Project advances to production or Zijin seeks to consolidate its ownership at a later stage, Xanadu Non-Associated Shareholders may benefit from a higher valuation exit opportunity. This enables Non-Associated Shareholders to realise near-term value while preserving future potential gains.
Strengthened balance sheet and financial flexibility	The US\$25 million cash inflow immediately strengthens Xanadu's balance sheet, providing liquidity to support corporate initiatives, exploration, and potential strategic acquisitions. With an improved financial position, Xanadu can execute the Company's broader business strategy with greater confidence and reduced reliance on capital markets for funding.  For example, Xanadu have indicated that the cash may be used to re-establish Xanadu's project portfolio via one or more transactions to acquire new projects and potentially include corporate as well as asset level acquisitions.

For personal use only

Advantage	Explanation
Optionality for future exit or production participation	By retaining a 25% interest in the Khuiten JV, Xanadu preserves the flexibility to evaluate the Company's position at a later stage. Future pathways include: <ul style="list-style-type: none"> <li>Potentially selling Xanadu's residual stake at a higher valuation post-development; or</li> <li>Retaining Xanadu's stake into commercial production to benefit from long-term cash flow generation. The Proposed Transaction's structure ensures Xanadu is not locked into a single outcome but can reassess the Company's position based on market conditions and the Kharmagtai Project's progress.</li> </ul>
Leverages Zijin's financial strength	Zijin is a globally recognised mining company, with extensive experience in developing and operating large-scale projects and access to significantly more capital and scale than Xanadu. By structuring the Proposed Transaction in a way that aligns Xanadu and Zijin's economic interests, Non-Associated Shareholders benefit from Zijin's financial resources and/or borrowing capacity to improve the likelihood of funding the Kharmagtai Project's development to commencement of commercial operations.
Potential market re-rating for Xanadu	By eliminating near-term capital requirements, the Proposed Transaction may reduce investors' perceived investment risk and enhance Xanadu's attractiveness. This could lead to an improved share price and broadened investor interest in Xanadu, supporting overall shareholder value.

Source: BDOCF analysis

### 2.3.3 Disadvantages of the Proposed Transaction

Table 2.3 below outlines the potential disadvantages to the Non-Associated Shareholders of approving the Proposed Transaction.

**Table 2.3: Potential disadvantages of the Proposed Transaction**

Disadvantage	Explanation
Reduced ownership	By selling 50% of Xanadu's interest in the Khuiten JV, Xanadu reduces the Company's effective ownership in the Kharmagtai Project from 38.25% to 19.13%. If the Kharmagtai Project experiences significant exploration success or if commodity prices appreciate, the potential upside for Non-Associated Shareholders is lower than if Xanadu had retained its full stake. While Xanadu retains an 25% interest, it will ultimately receive a smaller portion of the Kharmagtai Project's revenues in the long term.
Loss of strategic influence in the Khuiten JV	Reducing Xanadu's interest in the Khuiten JV to 25% weakens the Company's ability to influence decision-making regarding the Kharmagtai Project's development. For instance, after the implementation of the Proposed Transaction, Xanadu will only have the right to appoint a single Director to the Khuiten JV Board along with the appointment of a Deputy General Manager. In comparison, Zijin will have the right to appoint three Directors and, therefore, hold a 75% majority interest, in addition to the right to appoint the General Manager.  For completeness, we note that there is shared control, at best, prior to the Proposed Transaction. We do not consider the reduction in strategic influence post the transaction to be particularly large.
Future repayment obligations from loan structure	Although the Proposed Transaction eliminates Xanadu's funding requirements in the near term, Xanadu's share of development costs will be recovered by Zijin from future cash flows. This means that once the Kharmagtai Project reaches production, Xanadu will receive lower initial cash distributions until Xanadu's share of the costs are repaid. If Kharmagtai Project's development is delayed or costs escalate, the period before Xanadu realises net positive cash flow could be extended, impacting Xanadu's economic returns.

Source: BDOCF analysis

### 2.3.4 Other considerations

#### Funding considerations

In Xanadu's 21 January 2025 ASX announcement, the Company announced the approval of a modest Khuiten JV budget for the first quarter of 2025 of circa US\$2.1 million in lieu of consideration of the full next stage strategic plan and budget expected to be presented at the Khuiten JV Board meeting scheduled to occur in February 2025. We understand that the budget for this next stage of development activities cannot be approved without Xanadu having a viable funding solution in place.

To this end, Xanadu has appointed Bacchus Capital to lead a process to secure funding for Xanadu's 50% interest in the Kharmagtai Project until the Kharmagtai Project's next major decision point. In this next decision point, Xanadu would need an estimated US\$25-30M, representing Xanadu's share of the Bankable Feasibility Study ('BFS') stage, running into late 2026 or early 2027, to be followed by 2-3 years of construction and commissioning, where Management estimates Xanadu's share at approximately US\$425-450 million. If Xanadu is unable to fund these amounts, the Company would need to either materially slow down progress on the Kharmagtai Project or accept significant dilution.

As at the date of this Report, we understand that Xanadu has been working closely with Bacchus Capital to establish funding options. Due to the stage of the project and the scale of Xanadu, funding for construction cannot yet be achieved. Term sheets have been received that could fund Xanadu's share of the BFS, which would include packages of debt, equity, offtake arrangements and royalties, noting that debt, offtake arrangements and royalty options all require collateral commitments from the Khuiten JV and thus require Zijin approval.

We understand that Xanadu is in discussion with Zijin about such collateral commitments but has not yet received firm commitments of support. As a result, there remains a material risk that Zijin, in its capacity as a Khuiten JV partner, will block any combination of debt, offtake arrangements and/or royalty options. For this reason, the Xanadu Board of Directors judges that the only high confidence option to fund Xanadu's share of the BFS funding will be via capital raising in the form of equity at the Xanadu corporate level.

If the Proposed Transaction is not approved, and in the absence of a better offer, Xanadu would plan to raise the required US\$25-30M necessary for the BFS by raising equity. In parallel, the effort would commence to find a funding solution to the larger construction costs, noting that a completed BFS would be required before construction funding can be finalised.

At the date of this Report, the outcome of the above processes and discussions are unknown. It is possible that, ultimately, Xanadu may secure sufficient funding on financial terms favourable to Xanadu Non-Associated Shareholders. However, it is possible that such funding may not eventuate.

Whilst Xanadu is not required to exercise the 25% Put Option granted under the JV agreement until six months after the delivery of the PFS (i.e. the end of the exercise period), the 25% Put Option has a condition precedent requiring that Xanadu obtain approval from the Company's Non-Associated Shareholders for the purpose of ASX Listing Rule 10.1 and any other Listing Rules of the ASX or the trading rules of the Toronto Stock Exchange ('TSX') prior to exercising the 25% Put Option.

The Directors of Xanadu are requesting shareholder approval to provide the flexibility to exercise the Put Option if they consider this to be in the best interests of the Company.

### 2.3.5 Position of the Non-Associated Shareholders if the Proposed Transaction is not approved

Table 2.4 below outlines the potential position of Xanadu Non-Associated Shareholders if the Proposed Transaction is Not Approved.

**Table 2.4: Position of Non-Associated Shareholders if the Proposed Transaction is not approved**

Position of Non-Associated Shareholders	Explanation
Xanadu retains its full 50% interest in the Khuiten JV	If the transaction is not approved, Xanadu will continue to own 50% of the Khuiten JV, preserving its 38.25% effective interest in the Kharmagtai Project. This means Non-Associated Shareholders retain a larger share of future cash flows and potential upside if the Kharmagtai Project successfully advances to production. However, this also comes with additional financial and funding obligations.
Significant capital required for the development of the Kharmagtai Project	Without the transaction, Xanadu will need to fund its full 50% share of the Khuiten JV's development costs. Given that the Kharmagtai Project is in the pre-development phase, these costs are expected to be substantial, requiring Xanadu to secure external funding through debt and/or equity.
Risk of shareholder dilution	Xanadu does not have sufficient cash reserves to meet its expected funding obligations. If alternative funding sources cannot be secured, Xanadu will likely need to raise capital through an equity issuance, resulting in the dilution of existing Non-Associated Shareholders. Depending on market conditions, a capital raise could be at a discount to Xanadu's current share price, further eroding shareholder value.
Potential dilution of Xanadu's interest in the Khuiten JV	If Xanadu is unable to fund its share of development costs in a timely manner, the Kharmagtai Project's progress may be delayed. Under the terms of the Khuiten JV agreement, Zijin would be entitled to meet Xanadu's funding obligations and cause the dilution of Xanadu's interest by allowing Zijin to issue new shares in the Khuiten JV.  This can only happen for funding obligations under an approved JV budget and, as a 50% JV owner, Xanadu can vote to reject budgets which Xanadu cannot fund. This partially mitigates dilution risk at the Khuiten JV level but correspondingly increases the risk of delays to the Kharmagtai Projects more broadly.
Higher exposure to development and execution risks	Retaining a larger stake in the Kharmagtai Project means that Xanadu Non-Associated Shareholders also retain a higher level of exposures to the following risks: <ul style="list-style-type: none"> <li>• Potential cost overruns;</li> <li>• Permitting and regulatory risks;</li> <li>• Construction delays; and</li> <li>• Fluctuations in commodity prices.</li> </ul>
Reduced financial flexibility for Xanadu	Without the US\$25 million upfront cash injection, Xanadu will have less financial flexibility to pursue exploration, acquisitions, or corporate initiatives. This may limit Xanadu's ability to capitalise on other value-enhancing opportunities while it remains focused on meeting its Kharmagtai Project funding obligations.
Risk of an unfavourable future exit	If Xanadu later decides to sell its 50% interest in the Khuiten JV, the Company may be in a weaker negotiating position, particularly if it faces financial distress or funding constraints. The lack of a pre-agreed transaction with Zijin means Xanadu could struggle to secure a competitive sale price in the future.



Position of Non-Associated Shareholders	Explanation
Non-recoverable costs	Xanadu will incur, or has incurred, costs in relation to the Proposed Transaction irrespective of whether the Proposed Transaction is implemented. Xanadu will not be able to recover costs that it has incurred in relation to the Proposed Transaction in the event that the Proposed Transaction is not approved and/or implemented.

Source: *BDOCF analysis*

### 2.3.6 Assessment of the reasonableness of the Proposed Transaction

In our opinion, after considering all of the issues set out in this Report, it is our view that, in the absence of any other information or a superior proposal, the Proposed Transaction is **Reasonable** to the Non-Associated Shareholders as at the date of this Report.

### 2.4 Opinion

After considering the above assessments, it is our view that, in the absence of any other information or a superior proposal, the Proposed Transaction is **Fair and Reasonable** to the Non-Associated Shareholders as at the date of this Report.

Before forming a view on whether to vote in favour of or against the Proposed Transaction, Non-Associated Shareholders must:

- ▶ Have regard to the information set out in the balance of this Report, including the Important Information set out in Section 3;
- ▶ Consult their own professional advisers; and
- ▶ Consider their specific circumstances.

For personal use only

## 3.0 Important information

### 3.1 Read this Report, and other documentation, in full

This Report, including Part I, Part II and the appendices, should be read in full to obtain a comprehensive understanding of the purpose, scope, basis of evaluation, limitations, information relied upon, analysis, and assumptions underpinning our work and our findings.

Other information provided to the Non-Associated Shareholders in conjunction with this Report should also be read in full, including the Notice of Meeting.

### 3.2 Non-Associated Shareholders' individual circumstances

Our analysis has been completed and our conclusions expressed at an aggregate level having regard to the Non-Associated Shareholders as a whole. BDOCF has not considered the impact of the Proposed Transaction on the particular circumstances of individual Non-Associated Shareholders. Individual Non-Associated Shareholders may place a different emphasis on certain elements of Proposed Transaction relative to the emphasis placed in this Report. Accordingly, individual Non-Associated Shareholders may reach different conclusions as to whether or not Proposed Transaction is fair and reasonable in their individual circumstances.

The decision of an individual Non-Associated Shareholder to vote in favour of or against the Proposed Transaction is likely to be influenced by their particular circumstances and accordingly, the Non-Associated Shareholders are advised to consider their own circumstances and seek their own independent advice.

Voting in favour of or against the Proposed Transaction is a matter for individual Non-Associated Shareholders based on their expectations as to the expected value, future prospects and market conditions together with their particular circumstances, including risk profile, liquidity preference, portfolio strategy and tax position. The Non-Associated Shareholders should carefully consider the Notice of Meeting. Non-Associated Shareholders who are in doubt as to the action they should take in relation to Proposed Transaction should consult their professional adviser.

With respect to the taxation implications of the Proposed Transaction, it is strongly recommended that the Non-Associated Shareholders obtain their own taxation advice, tailored to their own particular circumstances.

### 3.3 Scope

In this Report we provide our opinion on whether Proposed Transaction is fair and reasonable to the Non-Associated Shareholders.

This Report has been prepared at the request of the Non-Associated Directors for the sole benefit of the Non-Associated Shareholders entitled to vote, to assist them in their decision to vote in favour of or against the Proposed Transaction. This Report is to accompany the Notice of Meeting to be sent to the Non-Associated Shareholders to consider the Proposed Transaction and was not prepared for any other purpose. Accordingly, this Report and the information contained herein may not be relied upon by anyone other than the Non-Associated Directors and the Non-Associated Shareholders without our written consent. We accept no responsibility to any person other than the Non-Associated Directors and the Non-Associated Shareholders in relation to this Report.

This Report should not be used for any other purpose and we do not accept any responsibility for its use outside this purpose. Except in accordance with the stated purpose, no extract, quote or copy of this Report, in whole or in part, should be reproduced without our written consent, as to the form and context in which it may appear.

We have consented to the inclusion of this Report with the Notice of Meeting. Apart from this Report, we are not responsible for the contents of the Notice of Meeting or any other document associated with the Proposed Transaction. We acknowledge that this Report may be lodged with regulatory authorities to obtain the relevant approvals prior to it being made available to the Non-Associated Shareholders.

The scope of procedures we have undertaken has been limited to those procedures required in order to form our opinion. Our procedures did not include verification work nor constitute an audit or assurance engagement in accordance with Australian Auditing and Assurance Standards. In preparing this Report we considered a range of matters, including the necessary legal requirements and guidance of the Corporations Act 2001 (Cth) ('the Corporations Act'), the Corporation Regulations 2001 ('the Regulations'), the regulatory guides ('RGs') published by ASIC, the listing requirements of the relevant exchanges (where relevant) and commercial practice.

In forming our opinion, we have made certain assumptions and outline these in this Report including:

- ▶ We have performed our analysis on the basis that the conditions precedent to Proposed Transaction are satisfied;
- ▶ That matters such as title to all relevant assets, compliance with laws and regulations and contracts in place are in good standing, and will remain so, and that there are no material legal proceedings, other than as publicly disclosed;
- ▶ All information which is material to the Non-Associated Shareholders' decision on Proposed Transaction has been provided and is complete, accurate and fairly presented in all material respects;
- ▶ Australian Securities Exchange ('ASX') announcements and other publicly available information relied on by us are accurate, complete and not misleading;

- ▶ If the Proposed Transaction is approved, that it will be implemented in accordance with the stated terms outlined in the Offer;
- ▶ The legal mechanism to implement the Proposed Transaction is correct and effective;
- ▶ There are no undue changes to the terms and conditions of the Proposed Transaction or complex issues unknown to us; and
- ▶ A range of other assumptions as outlined in this Report have also been adopted in forming our opinion.

In this Report we have not provided any taxation, legal or other advice of a similar nature in relation to the Proposed Transaction. Xanadu has engaged other advisors in relation to those matters.

Xanadu has acknowledged that the Company's engagement of BDOCF is as an independent contractor and not in any other capacity, including a fiduciary capacity.

The statements and opinions contained in this Report are given in good faith and are based upon our consideration and assessment of the information provided by Xanadu's Board of Directors ('the Board'), executives and management of all the entities.

### 3.4 Purpose of this Report

An independent expert, in certain circumstances, must be appointed to meet the requirements set out in the Corporations Act, the Regulations, RGs and in some cases the listing requirements of the relevant exchanges. These requirements have been set out in Sections 3.4.1 and 3.4.2 below

#### 3.4.1 Requirements of the Corporations Act

This Report has not been prepared for the purpose of complying with any requirements of the Corporations Act.

#### 3.4.2 Listing requirements

ASX Listing Rule 10.1 requires a listed entity to obtain shareholder approval prior to the disposal of a substantial asset by an entity (or a subsidiary of the entity) to certain persons, including:

- ▶ ASX Listing Rule 10.1.3: a person who is, or was at any time in the 6 months before the transaction or agreement, a substantial (greater than 10%) holder in the entity;
- ▶ ASX Listing Rule 10.1.4: an associate of a person referred to in ASX Listing Rule 10.1.3; or
- ▶ ASX Listing Rule 10.1.5: a person whose relationship to the entity or a person referred to in ASX Listing Rules 10.1.1 to 10.1.4 is such that, in the ASX's opinion, the transaction should be approved by security holders.

ASX Listing Rule 10.2 defines an asset as substantial if its value or the consideration for it is, or in ASX's opinion is, 5% or more of the value of the equity interests of the entity, as set out in the latest accounts given to the ASX in accordance with the ASX listing rules ('Substantial Asset').

Based on Xanadu's latest accounts given to the ASX as at 30 June 2024, Xanadu's equity interests is A\$64.5 million. The estimated value of the Proposed Transaction is greater than US\$25 million, being the purchase price under the 25% Put Option and the elimination of Xanadu's funding risk via a funding loan between Xanadu and Zijin for the duration of the Kharmagtai Project's development (see Section 4.2.1 for further details).

For the purposes of the ASX's Listing Rules, 'dispose of' is given a broad meaning and includes exercising an option to dispose of an asset, as well as granting a security interest over an asset. We understand that the Proposed Transaction falls within ASX Listing Rule 10.1 given the following:

- ▶ Jinping (Singapore) Mining Pte Ltd is a wholly owned indirect subsidiary of Zijin and is therefore an associate for the purposes of the ASX's Listing Rules;
- ▶ Zijin holds approximately 18.82% of Xanadu's total issued share capital as at the date of the NOM and is therefore a substantial (i.e. greater than 10%) holder; and
- ▶ The Proposed Transaction involves two interrelated disposals of substantial assets given that the consideration payable for the Proposed Transaction and the associated disposals is US\$25 million plus the granting by Zijin of a loan to fund Xanadu's share of the Khuiten JV's development CAPEX.

Given the above circumstances, we understand that the Proposed Transaction will result in the disposal of a Substantial Asset to an associate of a substantial holder, by way of exercising of the 25% Put Option and the granting of security over Xanadu's remaining interest in the Khuiten JV as part of the funding loan between Xanadu and Zijin.

Accordingly, Xanadu is seeking shareholder approval under ASX Listing Rule 10.1 and this Report has been prepared to comply with the requirements of ASX Listing Rules 10.1, 10.2 and 10.5, having regard to the Proposed Transaction.

### 3.5 Current market conditions

Our opinion and the analysis set out in this Report is based on economic, commodity, market and other conditions prevailing at the date of this Report. Such conditions can change significantly over relatively short periods of time and may have a material impact on the results presented in this Report and result in any valuation or other opinion becoming quickly outdated and in need of revision.

In circumstances where we become aware of and believe that a change in these conditions, prior to the Meeting, results in a material statement in this Report becoming misleading, deceptive or resulting in a material change in valuation, we will provide supplementary disclosure to Xanadu. BDOCF is not responsible for updating this Report following the Meeting or in the event that a change in prevailing circumstance does not meet the above conditions.

### 3.6 Reliance on information

Xanadu recognises and confirms that, in preparing this Report, except to the extent to which it is unreasonable to do so, BDOCF, BDO Services Pty Ltd or any of the partners, directors, agents or associates (together 'BDO Persons'), will be using and relying on publicly available information and on data, material and other information furnished to BDO Persons by Xanadu, its management ('Management'), and other parties, and may assume and rely upon the accuracy and completeness of, and is not assuming any responsibility for independent verification of, such publicly available information and the other information so furnished.

Unless the information we are provided suggests the contrary, we have assumed that the information provided was reliable, complete and not misleading, and material facts were not withheld. The information provided was evaluated through analysis and inquiry for the purpose of forming an opinion as to whether or not the Proposed Transaction is fair and reasonable.

We do not warrant that our inquiries have identified or verified all of the matters which an audit, extensive examination or due diligence investigation might disclose. In any event, an opinion as to whether a corporate transaction is fair and reasonable is in the nature of an overall opinion rather than an audit or detailed investigation.

It is understood that the accounting information provided to us was prepared in accordance with generally accepted accounting principles.

Where we relied on the views and judgement of Management, the information was evaluated through analysis and inquiry to the extent practical. Where we have relied on publicly available information, we have considered the source of the information and completed our own analysis to assist us to determine the accuracy of the information we have relied on. However, in many cases the information we have relied on is often not capable of external verification or validation and on that basis we provide no opinion or assurance on the information.

The Non-Associated Directors represent and warrant to us for the purpose of this Report, that all information and documents furnished by Xanadu (either by Management directly or through its advisors) in connection or for use in the preparation of this Report do not contain any untrue statements of a material fact or omit to state a material fact necessary in order to make the statements therein. We have received representations from the Non-Associated Directors in relation to the completeness and accuracy of the information provided to us for the purpose of this Report.

Under the terms of our engagement, Xanadu has agreed to indemnify BDO Persons against any claim, liability, loss or expense, costs or damage, arising out of reliance on any information or documentation provided, which is false or misleading or omits any material particulars, or arising from failure to supply relevant documentation or information.

### 3.7 Glossary

Capitalised terms used in this Report have the meanings set out in the glossary. A glossary of terms used throughout this Report is set out in Appendix A.

All dollar ('\$' or 'A\$') references in this Report are in Australian dollars unless otherwise stated.

### 3.8 Sources of information

This Report has been prepared using information obtained from sources including the following:

- ▶ Xanadu annual report for the year ended 31 December 2021, 31 December 2022 and 31 December 2023;
- ▶ Xanadu's half-year draft report for the period ended 30 June 2024;
- ▶ Khuiten JV management accounts for the period ending 31 December 2024;
- ▶ Xanadu ASX announcements;
- ▶ Kharmagtai PFS Fin Model V10 Base Case 15\_Project\_Reviews\_SCV10A - silver.xlsx ('Resources Model');
- ▶ Kharmagtai PFS Model (Reserves Only).xlsx ('Reserves Model')
- ▶ Kharmagtai PFS Model (Simplified Version).xlsx ('Simplified Model')
- ▶ The Notice of Meeting;
- ▶ Capital IQ;
- ▶ IBISWorld;
- ▶ Consensus Economics;
- ▶ Other research publications and publicly available data as sourced throughout this Report;
- ▶ Various transaction documents provided by the Management of Xanadu and their advisors; and

► Discussions and other correspondence with Xanadu, Management and their advisers.

### 3.9 APES 225 Valuation Services

This assignment is a Valuation Engagement as defined by Accounting Professional & Ethical Standards Board professional standard APES 225 *Valuation Services* ('APES 225'). A Valuation Engagement is defined by APES 225 as 'an Engagement or Assignment to perform a Valuation and provide a Valuation Report where the Valuer is free to employ the Valuation Approaches, Valuation Methods, and Valuation Procedures that a reasonable and informed third party would perform taking into consideration all the specific facts and circumstances of the Engagement or Assignment available to the Valuer at that time.'

This Valuation Engagement has been undertaken in accordance with the requirements set out in APES 225.

### 3.10 Forecast information

Any forecast financial information referred to in this Report has originated from Management and is adopted by the Non-Associated Directors in order to provide us with a guide to the potential financial performance of Xanadu. There is a considerable degree of subjective judgement involved in preparing forecasts since they relate to event(s) and transaction(s) that have not yet occurred and may not occur. Actual results are likely to be different from the forecast financial information since anticipated event(s) or transaction(s) frequently do not occur as expected and the variation between actual results and those forecast may be material.

The Non-Associated Directors' best-estimate assumptions on which the forecast is based relate to future event(s) and/or transaction(s) that Management expect to occur and actions that Management expect to take and are also subject to uncertainties and contingencies, which are often outside the control of Xanadu. Evidence may be available to support the Non-Associated Directors' best-estimate assumptions on which the forecast is based however, such evidence is generally future-oriented and therefore speculative in nature. In certain circumstances, we may adjust the forecast assumptions provided by Management to complete our valuation work. In this instance, the forecasts we have adopted for our valuation work will not be the same as the forecasts provided by Management.

BDOCF cannot and does not provide any assurance that any forecast is representative of results or outcomes that will actually be achieved. While we have considered the forecast information to the extent we considered necessary to complete the analysis set out in this Report, we have not been engaged to provide any form of assurance conclusion on any forecast information set out in this Report. We disclaim any assumption of responsibility for any reliance on this Report, or on any forecast to which it relates, for any purpose other than that for which it was prepared. We have assumed, and relied on representations from certain members of Management, that all material information concerning the prospects and proposed operations of Xanadu has been disclosed to us and that the information provided to us for the purpose of our work is true, complete and accurate in all respects. We have no reason to believe that those representations are false.

### 3.11 Qualifications

BDOCF has extensive experience in the provision of corporate finance advice, including takeovers, valuations and acquisitions. BDOCF holds an Australian Financial Services Licence issued by ASIC for preparing expert reports pursuant to the Listing Rules of the ASX and the Corporations Act.

BDOCF and its related parties in Australia have a wide range of experience in transactions involving the advising, auditing or expert reporting on companies that have operations domestically and in foreign jurisdictions. BDO in Queensland and in Australia is a national association of separate partnerships and entities and is a member of the international BDO network of individual firms.

Mark Whittaker and Scott Birkett have prepared this Report with the assistance of staff members. Mr Whittaker, BCom (Hons), FCA, CFA, and Mr Birkett, BBusMan/BCom, CFA are directors of BDOCF. Both Mr Whittaker and Mr Birkett have extensive experience in corporate advice and the provision of valuation and professional services to a diverse range of clients, including large private, public and listed companies, financial institutions and professional organisations. Mr Whittaker and Mr Birkett are considered to have the appropriate experience and professional qualifications to provide the advice offered within this Report.

BDO Corporate Finance Ltd



Mark Whittaker  
Director



Scott Birkett  
Director

## PART II: INFORMATION SUPPORTING OUR OPINION ON THE PROPOSED TRANSACTION

### 4.0 Overview of the Proposed Transaction

This section sets out an overview of the Proposed Transaction and is structured as follows:

- ▶ Section 4.1 describes the background of the Proposed Transaction; and
- ▶ Section 4.2 provides a summary of the Proposed Transaction.

This section is a summary only and should not be treated as a complete description of the Proposed Transaction. The Non-Associated Shareholders should refer to the Notice of Meeting and any subsequent disclosures for additional information relating to the Proposed Transaction and the key parties involved.

#### 4.1 Background of the Proposed Transaction

##### 4.1.1 The Kharmagtai Project

The Kharmagtai Project is located in Omnogovi Province, approximately 420km southeast of Ulaanbaatar, the capital of Mongolia. It is within the South Gobi porphyry copper province which hosts most of the known porphyry deposits in the South Gobi region of Mongolia, including the Oyu Tolgoi copper-gold operations (120km south), the Tsagaan Suvarga porphyry copper-molybdenum development (170km east) and Xanadu's Oyut Ulaan porphyry copper-gold exploration project (260km northeast). The Kharmagtai project is 76.5% owned by the Khuiten JV, 13.5% owned by Ganbayar Lkhagvasuren and 10% owned by Mongol Metals LLC ('MML') (the project ownership is discussed further in Section 5.1.1).

Figure 4.1 illustrates the location of the Kharmagtai Project in relation to key landmarks.

Figure 4.1: Location of the Kharmagtai Project

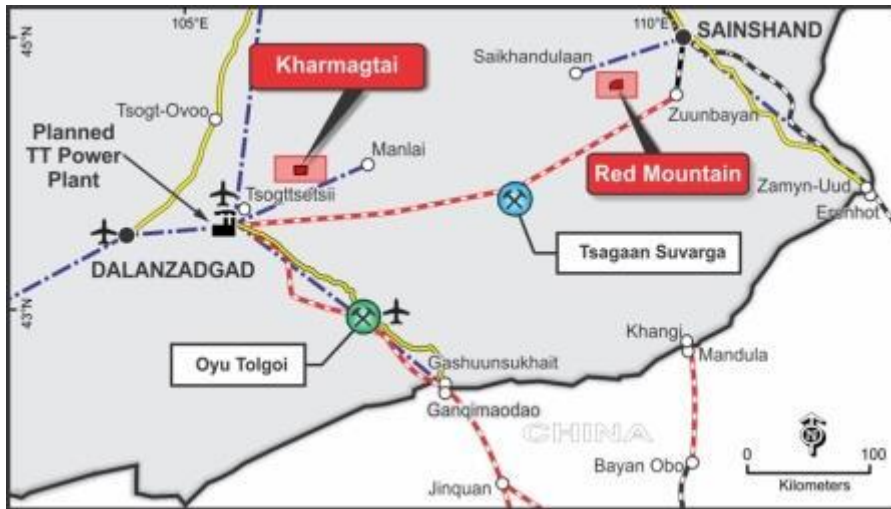

Source: Xanadu's website

Xanadu published a prefeasibility study ('PFS') in October 2024, which confirms the potential of the Kharmagtai Project as a globally significant, long life, low cost, low risk future copper-gold mine. At the time, the PFS indicated that the Kharmagtai Project will require approximately US\$890 million in pre-production CAPEX. Xanadu would be required to contribute 50% of the Khuiten JV's capital requirement (i.e. 50% of a 76.5% indirect economic interest). At the time of the announcement of the PFS by Xanadu, this proportional share of pre-production CAPEX exceeds Xanadu's market capitalisation.

##### 4.1.2 Partnership with Zijin

To assist in progressing the Kharmagtai Project, on 19 April 2022 Xanadu announced a strategic partnership with Zijin. Zijin is a large global mining group listed on the Shanghai stock exchange and the Hong Kong stock exchange. Zijin engages in the exploration and extraction of copper, gold, zinc, lithium, silver and molybdenum<sup>2</sup>.

<sup>2</sup> Zijin website

As at the 31 January 2025, Zijin had a market capitalisation of approximately 445.8 billion Hong Kong dollars ('HKD') (US\$57.2 billion<sup>3</sup>) .

Zijin's key financial information is summarised in Table 4.1 below.

**Table 4.1: Key financial information of Zijin**

(US\$m)	2021	2022	2023
Revenue	24,420	39,902	41,227
EBITDA	5,042	5,913	5,834
Net Profit after Tax ('NPAT')	3,039	3,686	3,750
Operating Cash Flows	4,042	4,268	5,209
Net Tangible Assets	3,650	2,593	5,215

Source: Capital IQ as at 10 February 2025

Zijin operates several mines globally, including:

- ▶ The Ashele Copper Mine, located in Xinjiang, China, approximately 1,500 km from the Kharmagtai Project. Zijin holds a 51% interest in the Ashele Copper Mine; and
- ▶ The Duobaoshan Copper Mine, situated in Heilongjiang Province, China, about 1,700 km from the Kharmagtai Project. Zijin holds a 100% interest in the Duobaoshan Copper Mine.

Both Ashele Coper Mine and Duobaoshan Copper Mine are in the production phase.

The partnership with Zijin had phases of investment between the two parties including:

- ▶ Phase 1: 139,000,000 share placement at \$0.04 per share, which represented a 38% premium to the last close price which gave Zijin 9.9% ownership of Xanadu;
- ▶ Phase 2: 139,000,000 share placement at \$0.04 per share which increased Zijin's relevant interest in Xanadu to 19.99%. Zijin was also entitled to appoint one director to the board of Xanadu.; and
- ▶ Phase 3: Zijin and Xanadu established the Khuiten JV, which owns 76.5% of the Kharmagtai Project (85% of a 90% indirect economic interest).

The Khuiten JV agreement grants Xanadu the following two put options which can be exercised within 6 months following the completion of the Kharmagtai PFS:

- ▶ Option 1 - A put option granted by Zijin to Xanadu ('the 50% Put Option') which requires Zijin to purchase all shares owned by Xanadu in the Khuiten JV in exchange for US\$50 million; or
- ▶ Option 2 - The 25% Put Option granted by Zijin to Xanadu which requires Zijin to purchase 50% of all shares owned by Xanadu in the Khuiten JV in exchange for US\$25 million.

#### 4.1.3 Other alternatives available to Xanadu

In addition to the above options, the Xanadu Board have considered other options including:

- ▶ Securing funding for Xanadu's proportional share of the Khuiten JV's pre-production CAPEX until the next major decision point in the Kharmagtai Project via a process currently led by external advisors Bacchus Capital. As at the date of this Report, we understand that data room access has been provided to external parties for due diligence purposes and discussions are on-going; and
- ▶ A selldown of Xanadu's interest in the Khuiten JV either at the Xanadu company level or at one of the subsidiaries' level.

Further information in relation to the alternatives available to Xanadu are set out in the explanatory memorandum to Resolution 1 of the Notice of Meeting.

## 4.2 Summary of the Proposed Transaction

### 4.2.1 The 25% Put Option

The Xanadu Board are currently considering exercising Option 2 under the Khuiten JV agreement. This involves selling half of Xanadu's share in the Khuiten JV. In return, Xanadu will:

- ▶ Receive US\$25 million in cash; and
- ▶ Enter into a loan with Zijin which will fund Xanadu's respective proportion of all funding amounts on behalf of Xanadu until the commencement of commercial production of the Kharmagtai Project;
  - The loan is to be secured by Xanadu's entire shareholding in the Khuiten JV;
  - The loan will attract interest at an annual rate calculated based on the Secured Overnight Financing Rate ('SOFR'), based on a 6-month term, plus 5% with the interest accruing monthly; and

<sup>3</sup> Conversion is sourced from Capital IQ.

- 90% of all dividends and distributions due and payable to Xanadu will be used to repay the loan with Zijin, with such amounts to be used to repay interest and principal on the loan until such time as the loan is repaid in full by Xanadu to Zijin.

#### 4.2.2 Impact on cash flows

To illustrate the impact on Xanadu of exercising this option, in Figure 4.2 below we have set out:

- ▶ The base case cash flows that Xanadu is expected to be required to fund to develop the Kharmagtai Project and then the cash flows that Xanadu is expected to be entitled to once operations commence (these cash flows are discussed in detail in Section 8.4 below); and
- ▶ The underlying cash flows derived from the Kharmagtai Project that Xanadu is expected to be entitled to (excluding the US\$25 million exercise price) if it exercises the 25% Put Option, including the following assumptions:
  - The underlying Kharmagtai Project base case cash flows are identical both pre and post Proposed Transaction;
  - Interest payments corresponding to 9.85 percent on the Zijin loan calculated based on the SOFR 180 days average as at 31 January 2025<sup>4</sup> plus 5 percent;
  - Xanadu receiving a 25% cash distribution from the Khuiten once the Kharmagtai Project reaches commercial production; and
  - Xanadu using 90% of the cash distribution to repay the loan with Zijin until fully repaid.

Figure 4.2: Cash flow comparison: base case vs 25% option

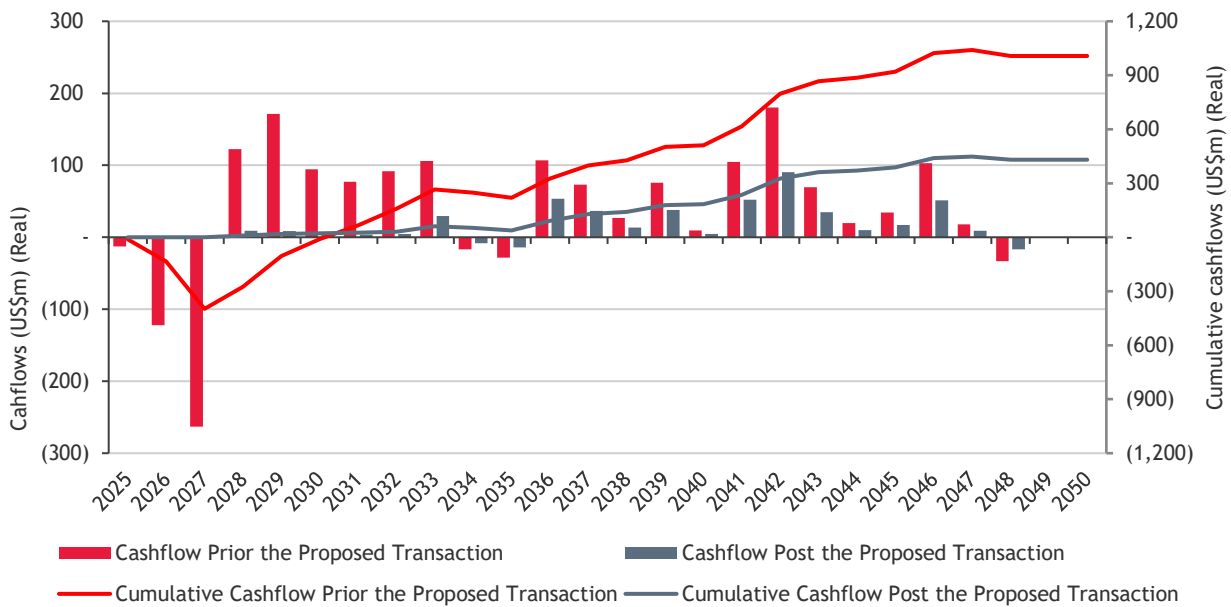

Source: BDOCF Analysis

#### 4.2.3 Strategic rationale

Table 4.2 below sets out a summary of our understanding of Xanadu’s strategic rationale for considering exercising the 25% Put Option.

<sup>4</sup> Federal Reserve Bank of New York: <https://www.newyorkfed.org/markets/reference-rates/sofr>



**Table 4.2: Summary of Xanadu’s strategic rationale**

Category	Description
Immediate capital realisation without full divestment	<p>The US\$25 million upfront cash consideration provides immediate liquidity, strengthening Xanadu’s balance sheet and reduces its reliance on external funding (i.e. equity raising or debt financing).</p> <p>This capital injection provides Management with options including but not limited to:</p> <ul style="list-style-type: none"> <li>▶ Capital can be redeployed into other strategic initiatives (e.g. progress exploration activity on existing projects, acquire new project(s), working capital, preserving financial flexibility in anticipation of other future transactions); or</li> <li>▶ Returning capital to Non-Associated Shareholders.</li> </ul> <p>Management have also indicated that the funding will enable Xanadu to restructure the Company’s operations ahead of new project(s) and to enable careful technical and commercial monitoring of the Kharmagtai Project, including maintaining a continued seat on the Khuiten JV’s Board.</p> <p>Regardless of the above, exercising the 25% Put Option creates a small but meaningful liquidity event for the Company in the short term and allows it to maintain a significant interest in the Kharmagtai Project over the long term, avoiding potential further equity dilution. Xanadu retains exposure to future Kharmagtai Project upside rather than fully exiting. A full exit would crystallise the valuation at today’s market conditions without benefiting from future value.</p>
De-risking development costs while retaining future upside	<p>In October of 2024, Xanadu released the PFS for the Kharmagtai Project which highlighted pre-production CAPEX of US\$890 million, of which Xanadu would be required to fund 38.25%. Xanadu does not currently have the cash required to fund the Company’s share of this pre-production CAPEX and the Company must source significant funding to fund their proportional share of the underlying Kharmagtai Project’s CAPEX.</p> <p>Under the terms of the Proposed Transaction:</p> <ul style="list-style-type: none"> <li>▶ Zijin must pay Xanadu’s respective portion of all funding amounts required on behalf of Xanadu until commencement of commercial production at the Kharmagtai Project;</li> <li>▶ This will constitute an interest-bearing loan by Zijin to Xanadu secured by Xanadu’s entire shareholding in the JV;</li> <li>▶ Xanadu shall have no further funding obligations before commencement of commercial production of the Kharmagtai Project; and</li> <li>▶ Until such time as the loan is repaid in full, 90% of all dividends and distributions due and payable by the Khuiten JV to Xanadu on Xanadu’s shares will be directed to Zijin, first on any interest then on the principal.</li> </ul> <p>Please refer to Figure 5.2 above for the change in cash-flow profile before and after the Proposed Transaction is implemented.</p> <p>As a result of the above, Xanadu will no longer have near-term funding obligations and avoids the need for further capital raisings that could dilute existing Non-Associated Shareholders whilst continuing to be exposed to the potential upside in the Kharmagtai Project via Xanadu’s remaining 25% interest in the Khuiten JV when the mine reaches commercial production.</p>
Retaining influence over development of the Kharmagtai Project	<p>After the implementation of the Proposed Transaction, Xanadu will maintain a 25% interest in the Khuiten JV and some influence over the Kharmagtai Project via:</p> <ul style="list-style-type: none"> <li>▶ The right to nominate one Director to the Board of the Khuiten JV<sup>5</sup>; and</li> <li>▶ The right to nominate the Deputy General Manager who will support the General Manager with their duties, including setting development plans and budgets.</li> </ul> <p>Xanadu would remain a meaningful partner in the Kharmagatai Project, preserving some influence, albeit in a reduced capacity, over strategic decisions while avoiding the full financial and operational burden of execution.</p> <p>This allows Xanadu to benefit from Zijin’s technical expertise, capital strength, and operational capabilities as the Kharmagtai Project progresses towards commercial production whilst simultaneously keeping future asset monetisation options open at a potentially higher valuation post-development, when the Kharmagtai Project’s risk profile is lower.</p>
Potential valuation re-rating by investors	<p>Investors in junior mining companies may prefer de-risked asset exposure rather than highly dilutive early-stage and/or capital-intensive projects.</p> <p>The Proposed Transaction’s structure potentially reduces immediate and future funding concerns for Xanadu. In term, this has the potential to attract stronger market support from investors which may lead to a valuation rerating post-implementation of the Proposed Transaction.</p>

<sup>5</sup> Before the implementation of the Proposed Transaction, Xanadu currently has the right to appoint two Directors to the Board of the Khuiten JV.

Category	Description
Preserving optionality for future exit or production participation	<p>By retaining a 25% interest in the Khuiten JV, Xanadu retains flexibility to reassess its position as the Kharmagtai Project progresses. Potential future pathways include:</p> <ul style="list-style-type: none"> <li>▶ Selling Xanadu’s residual interest at a higher valuation post-development (i.e. a second stage exit at an optimised price); or</li> <li>▶ Retaining Xanadu’s interest into commercial production and benefiting from long-term cash flows without incurring upfront capital commitments.</li> </ul> <p>The Proposed Transaction provides Xanadu with optionality with the potential to benefit Non-Associated Shareholders in the medium to long-term.</p>

#### 4.2.4 Shareholder approval

Whilst Xanadu is not required to exercise the 25% Put Option granted under the JV agreement until six months after the delivery of the PFS (i.e. the end of the exercise period), the 25% Put Option has a condition precedent requiring that Xanadu obtain approval from the Company’s Non-Associated Shareholders for the purpose of ASX Listing Rule 10.1 and any other Listing Rules of the ASX or the trading rules of the Toronto Stock Exchange (‘TSX’) prior to exercising the 25% Put Option.

This Report has been prepared to provide information to Non-Associated Shareholders to enable them to form a view on whether to vote in favour of or against the Proposed Transaction in circumstances that the Xanadu Board elect to exercise the 25% Put Option.

Non-Associated Shareholders should refer to the Notice of Meeting and subsequent disclosures for more detailed information in relation to the Proposed Transaction.

For personal use only

## 5.0 Background of Xanadu

This section is set out as follows:

- ▶ Section 5.1 provides background information on Xanadu and the Company’s key projects;
- ▶ Section 5.2 summarises the equity structure of Xanadu;
- ▶ Section 5.3 summarises the share market trading in Xanadu shares; and
- ▶ Section 5.4 summarises the historical financial information of Xanadu.

### 5.1 Background and key projects

Xanadu is a dual-listed exploration company with a focus on the discovery and development of significant porphyry copper-gold deposits in Mongolia. The Company is listed on both the ASX and the TSX.

Xanadu has three current projects in Mongolia being the Kharmagtai Project, the Red Mountain copper-gold project (‘Red Mountain’) and the Sant Tolgoi copper-nickel project (‘Sant Tolgoi’).

Figure 5.1 set out below shows the location of these key projects.

Figure 5.1: Location of Xanadu’s projects

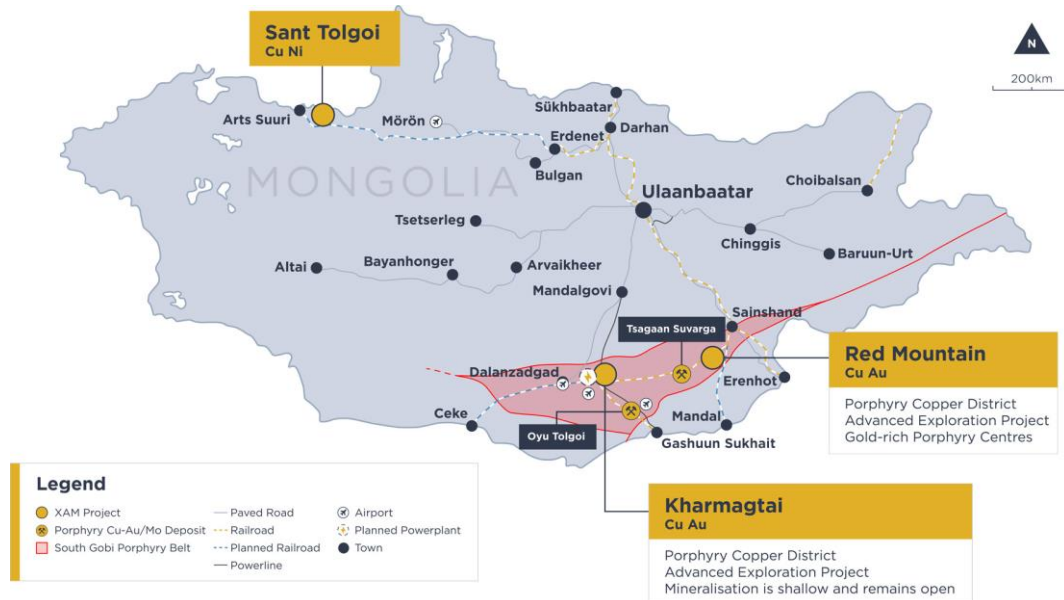

Source: Xanadu’s website

We have set out additional information in relation to Xanadu’s key projects below. For further detail in relation to Xanadu’s projects, refer to ERM’s Independent Technical Specialist’s Report, dated 11 March 2025, attached as Appendix B to this Report.

#### 5.1.1 Kharmagtai

In addition to the brief overview set out in Section 4.1.1 above, we have provided additional information below on:

- ▶ Ownership structure;
- ▶ Terms of the Khuiten JV;
- ▶ Deposits at Kharmagtai Project; and
- ▶ Key events since the scoping study.

##### Ownership Structure

The ownership structure of the Kharmagtai Project is set out in Figure 5.2 below. In the ownership structure, we note:

- ▶ Xanadu and Zijin are both parties and shareholders into the Khuiten JV. The Khuiten JV indirectly holds 76.5% of the rights, title and interest in the Kharmagtai Project (85% interest in Mongol Metals LLC’s 90% interest in Oyu Ulaan LLC (‘OU’)). Via the Khuiten JV, Xanadu and Zijin have agreed to work co-operatively to fund the exploration, development and operations of the Kharmagtai Project;

For personal use only

- ▶ Mogol Metals LLC will fund capital expenditure on QGX's behalf until the Kharmagtai Project's first commercial production. The amount will constitute a loan from MML to QGX. QGX will receive 10% of distributions from OU, 90% of which will be used to repay the loan with MML until the loan is fully repaid. The loan accrues interest at 1% + the prime rate of the Bank of Montreal ('Prime Rate') compounding quarterly; and
- ▶ Ganbayar Lkhagvasuren has a 5.6% interest without funding risk until the first decision by the board to proceed with a commercial mining development on the licence for the Kharmagtai Project ('Decision to Mine').

Figure 5.2: Kharmagtai Project ownership

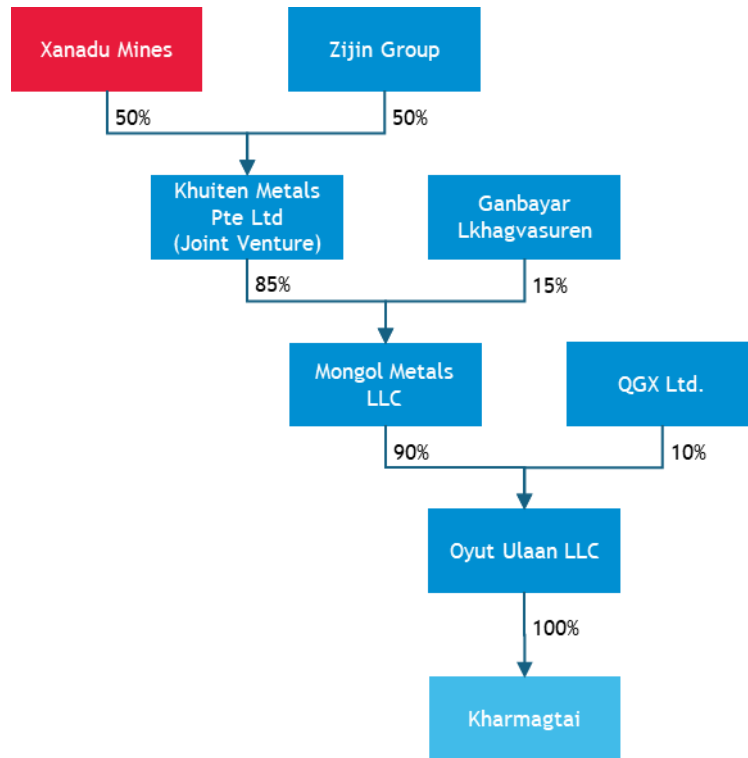

Source: Xanadu Management

*Khuiten Metals Pte Ltd Joint Venture Agreement ('the JV Agreement')*

On 21 December 2022, Xanadu announced the execution of formal documentation for Phases 2 and 3 of the transaction with Zijin, which included the formation of a 50:50 JV via the JV Agreement and through Xanadu's previously 100% owned subsidiary Khuiten. Khuiten holds a 76.5% effective interest in the Kharmagtai Project.

Both parties agreed to enter into an incorporated JV, henceforth referred to as the Khuiten JV for clarity, to work co-operatively to fund the exploration, development and operations of the Kharmagtai Project. In relation to the JV Agreement, we understand the following:

- ▶ The JV Agreement's commencement date is 21 December 2022 and terminates by unanimous vote of all shareholders or terminates for a shareholder if/when said shareholder no longer holds shares in the Khuiten JV or if the Khuiten JV is wound up or terminated.
- ▶ Each Shareholder is entitled to appoint one Director for each 25% of shares held in the Khuiten JV.
- ▶ Board meetings are held at least quarterly or at such other intervals as the Board of Directors of the Khuiten JV may determine. Shareholders who hold, in aggregate, more than a 50% interest can call a Board meeting upon notice. For each Board meeting, quorum is defined as attendance by at least one Director appointed by each shareholder.
- ▶ The JV Agreement is structured around a PFS Delivery Period which is defined as the period from the JV Agreement's commencement date until the earlier of the PFS delivery or 18 months from the commencement date. The PFS was delivered and announced on the ASX on 14 October 2024.
- ▶ The JV Agreement includes various clauses which vary before and after the PFS Delivery Period. Since Xanadu announced the delivery of the PFS on 14 October 2024, this summary of the JV Agreement's key terms will focus solely on the definitions and clauses which apply after the expiry of the PFS Delivery Period. For instance, following the expiry of the PFS Delivery Period, Zijin has the right to nominate the Chairperson whereas before the expiry of the PFS Delivery Period, Xanadu held that right.
- ▶ The Chairperson does not have a casting vote, in addition to an deliberative vote, at any meeting of the Board.

For personal use only

- ▶ All Khuiten JV Board of Directors decisions are binding on all the JV Agreement parties and all decisions are determined by a majority vote, defined as more than 50%.
- ▶ The Shareholders in the Khuiten JV appoint the General Manager and Deputy General Manager via a majority vote of the Board. However, following the expiry of the PFS Delivery Period, Zijin has the right to nominate the General Manager and Xanadu, provided that the Company holds at least 25% of the shares in the Khuiten JV, has the right to nominate the Deputy General Manager.
- ▶ The JV Agreement defines the General Manager's duties which, broadly, include but are not limited to the following: prepare and submit all development plans and budgets, manage the Khuiten JV's expenditures in accordance with the development plans and budgets, control all management, technical and labour personnel decisions necessary under the JV Agreement, etc.
- ▶ The JV Agreement also defines the Deputy General Manager's duties which, after the expiry of the PFS Delivery Period, broadly include but are not limited to the following: coordinate with Xanadu's technical team and facilitate their participation in the development and operation of the Kharmagtai Project and assist the General Manager in the development and operation of the Kharmagtai Project.
- ▶ The JV Agreement specifies that prior to the expiry of the PFS Delivery Period, Xanadu is the operator of the Khuiten JV, but Zijin is the operator thereafter.
- ▶ The Khuiten JV's development plans and budgets, prior to the expiry of the PFS Delivery Period, are included in the JV Agreement. Subsequent development plans and budgets are to be prepared by the management of the Khuiten JV (i.e. the General Manager and the Deputy General Manager) and endorsed by the Khuiten JV Board of Directors of the Khuiten JV. For completeness, the JV Agreement defines and includes a list of critical business matters which cannot be committed to without the prior approval of the Board by special majority vote or unanimous vote, as the case may be.
- ▶ The JV Agreement includes a put option, with key clauses summarised below:
  - Put option granted by Zijin to Xanadu to require Zijin to purchase either:
    - 50% of the Khuiten JV ('The 50% Put Option'); or
    - 25% of the Khuiten JV ('The 25% Put Option').
  - Put option exercise period: six months commencing on the date of the delivery of the PFS;
  - Option fee: \$1; and
  - Condition precedent: Xanadu must obtain approval from its shareholders for the purposes of ASX Listing Rule 10.1 or any other Listing Rule of the ASX or the trading rules of the TSX prior to exercising the put option.
- ▶ Each of the shareholders must fund the operational and other costs and expenditures of the Khuiten JV in accordance with their respective initial investments in the Khuiten JV, except in the case of the 25% Put Option shares in which case:
  - Zijin must pay Xanadu's respective portion of all funding amounts required on behalf of Xanadu until commencement of commercial production at the Kharmagtai Project;
  - This will constitute a loan, to be drafted, by Zijin to Xanadu secured by Xanadu's entire shareholding in the JV at an annual interest rate of Secured Overnight Financing Rate ('SOFR'), based on a six-month term, plus 5%;
  - This will constitute a loan by Zijin to Xanadu, secured against Xanadu's entire shareholding in the JV, at an annual interest rate of SOFR, based on a six-month term, plus 5%;
  - Xanadu shall have no further funding obligations before commencement of commercial production of the Kharmagtai Project; and
  - Until such time as the loan is repaid in full, 90% of all dividends and distributions due and payable by the Khuiten JV to Xanadu on Xanadu's shares will be directed to Zijin in repayment of the 25% Put Option loan, first on any interest then on the principal.
- ▶ For completeness, we note that 'the start of commercial production' is not defined in the JV agreement. Management have advised that Xanadu interprets this term as after commissioning is completed. However, this term would be defined when a loan agreement is signed and agreed by both Xanadu and Zijin reflecting the above terms and conditions.
- ▶ The shareholders in the Khuiten JV may agree by unanimous vote that the Khuiten JV's costs be financed through loan funds advanced by the shareholders in accordance with their respective portions.
- ▶ If one of the shareholders cannot meet its funding obligations, the other shareholder is entitled to meet the funding obligations of the defaulting shareholder and cause the dilution of the defaulting shareholder via the issuance of new shares.

- ▶ The JV Agreement includes mechanisms and definitions to calculate the number of new shares to be issued in various circumstances, including if/when a shareholder defaults on funding requirements. The mechanism to calculate the number of shares to be issued in exchange for a joint venture partner funding a defaulting shareholder's funding requirements specifies that the number of new shares issued is calculated as:
  - The number of shares on issue at the time of the default by one of the shareholders multiplied by a ratio which includes:
    - Numerator: The funding obligation that was required to be advanced by the defaulting shareholder (or another amount agreed by the shareholders in the case of other circumstances); and
    - Denominator: An implied amount of US\$100 million plus the cumulative total funding that the shareholders have provided after the end of the PFS Delivery Period.
- ▶ Management have advised that if/when a shareholder defaults on their funding obligation, the JV Agreement's share dilution mechanism described above is the sole remedy of the other joint venture partner.
- ▶ The JV Agreement also includes right of first refusal for the Khuiten JV partners as well as tag along rights and drag along rights allowing both parties to exercise some level of influence over any disposal of shares.
- ▶ Furthermore, a shareholder may transfer all or any shares held by that shareholder to any of the following permitted transferees:
  - Another existing shareholder;
  - A related corporation of the transferor (subject to various other clauses); and
  - An entity on seeking and obtaining a unanimous vote of shareholders in favour of such transfer.
- ▶ The JV Agreement includes a clause on dispute resolution which includes, but is not limited to:
  - A first dispute notice mechanism and the right to refer the dispute to arbitration and nominate an arbitrator; and
  - A second dispute notice mechanism and the right to reject the nominated arbitrator and the nomination of an arbitrator by the Chairperson of the Singapore International Arbitration Centre whose decision is final and binding on all parties.

#### Deposits

The Kharmagtai Project hosts six significant deposits: Stockwork Hill, White Hill, Copper Hill, Golden Eagle, Zephyr, and Zaraa<sup>6</sup>. In October 2024, the Kharmagtai Project received an updated Mineral Resource Estimate ('MRE') which reports approximately 1.6 million tonnes ('Mt') of contained Copper Metal ('Cu') and 4.0 million ounces ('Moz') of contained Gold ('Au').

A summary of the total resources can be found in Table 5.1 below.

**Table 5.1 Kharmagtai Project total resource**

Cutoff (% Copper equivalent ('CuEq'))	Classification	Tonnes (millions) ('Mt')	CuEq (%)	Grades		Contained Metal			
				Cu (%)	Au (g/t)	CuEq pounds 000's ('Mlbs')	CuEq (kt)	Cu (kt)	Au (koz)
0.13(OC)	Indicated	1,300	0.30	0.22	0.17	8,800	4,000	2,900	7,100
0.30(UG)	Inferred	900	0.28	0.21	0.13	5,600	2,500	1,900	4,000
	<b>Total</b>	<b>2,200</b>	<b>0.29</b>	<b>0.21</b>	<b>0.15</b>	<b>14,400</b>	<b>6,500</b>	<b>4,800</b>	<b>11,100</b>

Source: Xanadu ASX announcements 14 October 2024

Key Events Since Release of Scoping Study in 2022

Figure 5.3 below outlines the key events relating to the Kharmagtai Project since the release of the 2022 scoping study.

Figure 5.3: Kharmagtai Project key events since 2022

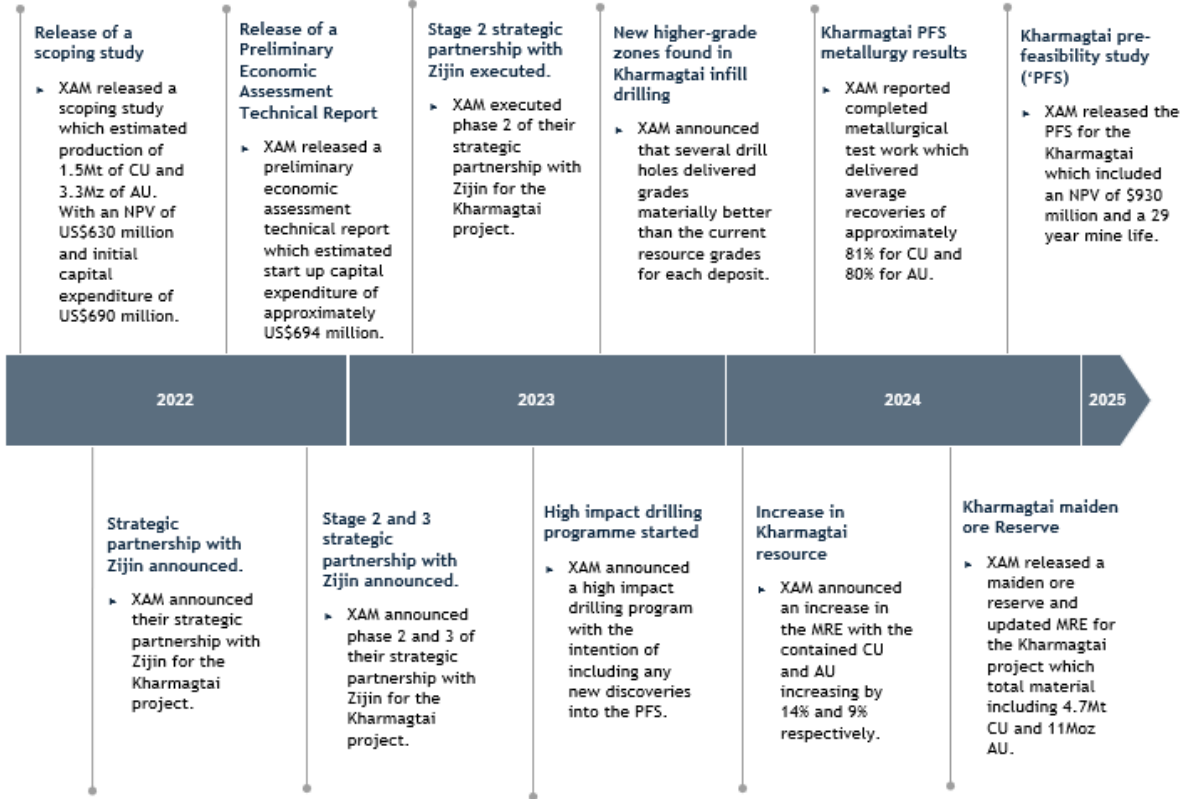

Source: Xanadu ASX announcements

5.1.2 Red Mountain

The Red Mountain project is located within the Dornogovi province of southern Mongolia, approximately 420km southwest of Ulaanbaatar.<sup>7</sup> The Red Mountain project is currently undergoing an exploration program with approximately 4,880 metres of diamond drilling completed to date. This program has successfully identified shallow, high-grade gold and copper-gold mineralisation across four prospects within the project area. Please refer to the ERM Report in Appendix B for more information.

Table 5.2 below details the best intersections found in the drilling program.

Table 5.2: Red Mountain Exploration Program Drilling Summary

Prospect	Best intersections
Target 33	<ul style="list-style-type: none"> <li>41 metres ('m') at 1.07 g/t Au from 38m; and</li> <li>29m at 0.54 g/t Au from 4m.</li> </ul>
Nowie	<ul style="list-style-type: none"> <li>8m at 1% Cu and 0.12 g/t AU from 267m; and</li> <li>14m at 0.75% Cu and 0.26 g/t Au from 113m.</li> </ul>
Target 10	<ul style="list-style-type: none"> <li>4m at 0.85% Cu and 1.52 g/t Au from 186m.</li> </ul>
Bavuu	<ul style="list-style-type: none"> <li>9.5m at 0.47% Cu and 0.21 g/t Au from 110.3m.</li> </ul>

Source: Xanadu ASX announcement 21 June 2024

5.1.3 Sant Tolgoi

The Sant Tolgoi project is a copper-nickel exploration project in Zavkhan Province, Western Mongolia, spanning over 40 km<sup>2</sup> across two exploration licenses. Xanadu has secured a binding agreement with STSM LLC, granting the right to acquire up to an 80% stake in the project. In November 2024, Xanadu reported strong surface copper assay results, with geological mapping, surface rock chip sampling and geophysics confirming the presence of several large

<sup>7</sup> Xanadu website

anomalies associated with outcropping mafic intrusions. Please refer to the ERM Report in Appendix B for more information.

## 5.2 Equity structure of Xanadu

### 5.2.1 Ordinary shares

As at 8 January 2025, Xanadu has 1,912,197,556 ordinary shares on issue. The substantial shareholders are set out in Table 5.3.

**Table 5.3: Substantial shareholders**

	Shareholders	Number of shares	Percentage holding
1	Jinping (Singapore) Mining Pte Ltd	359,817,003	18.82%
2	Citicorp Nominees Pty Ltd	282,214,774	14.76%
3	BNP Paribas Nominees Pty Ltd	133,603,847	6.99%
4	HSBC Custody Nominees (Australia) Limited	130,281,323	6.81%
5	Other shareholders	1,006,280,609	52.62%
	<b>Total shares on issue</b>	<b>1,912,197,556</b>	<b>100.00%</b>

Source: Xanadu share register as at 17 December 2024 and 8 January 2025 ASX Announcement

Having regard to the information set out in Table 5.3 above, we note:

- ▶ As at 8 January 2025 Xanadu has 1,912,197,556 fully paid ordinary shares outstanding, of which the top four shareholders hold 47.38%; and
- ▶ Jinping (Singapore) Mining Pte Ltd is a subsidiary of Zijin Mining Group Co which is a party to the JV Agreement, owns a 50% interest in the JV in addition to its 18.82% interest in Xanadu.

In addition to the above analysis, we have set out in Table 5.4 below a summary of the share distribution.

**Table 5.4: Share distribution**

Range of shares held	No. of shareholders	No. of ordinary shares	Percentage of issued shares (%)
1 - 10,000	444	2,503,094	0.13%
10,001 - 50,000	708	18,830,127	0.98%
50,001 - 250,000	565	70,229,736	3.67%
250,001 - 750,000	246	111,105,027	5.81%
750,001 - 3,000,000	139	202,150,236	10.57%
3,000,001 - 10,000,000	42	243,536,377	12.74%
10,000,001 - and over	19	1,263,842,959	66.09%
<b>Total</b>	<b>2,163</b>	<b>1,912,197,556</b>	<b>100.00%</b>

Source: Xanadu share register as at 17 December 2024 and 8 January 2025 ASX Announcement

Having regard to the information set out in Table 5.4 above, we note the following:

- ▶ Xanadu has a relatively concentrated share ownership, with 66.09% of all ordinary shares held by a relatively small group of shareholders (19); and
- ▶ Shareholders with interests between 1 - 50,000 shares represent the majority of shareholders by number but only own 1.11% of the Company.

### 5.2.2 Unlisted securities on issue

As at 31 December 2024, Xanadu have approximately 92.2 million unlisted options outstanding. These options are held by Xanadu directors and other key management personnel.

Table 5.5 below summarises Xanadu's outstanding options.

**Table 5.5: Xanadu's outstanding options**

Outstanding options	Number outstanding
Executive director options	30,054,000
Non-executive director options	13,560,000
Management options	48,570,000
<b>Total</b>	<b>92,184,000</b>

Source: Xanadu Management

The market based vesting conditions of the outstanding options are set out in Table 5.6 below.



**Table 5.6: Market based vesting conditions for the outstanding options**

Price hurdle (\$)	Number outstanding
0.03	26,400,000
0.18	16,000,000
0.28	34,784,000
-	15,000,000
<b>Total</b>	<b>92,184,000</b>

Source: Xanadu Management

Having regard to the information set out in Table 5.5 and Table 5.6 above, we note the following:

- ▶ All of the options are zero exercise price options;
- ▶ As well as the price hurdle's set out in Table 5.6 above, all the options contain technical non-market based hurdles. Largely, the technical hurdles related to the delivery of Kharmagtai Project related goals and milestones;
- ▶ A portion of the options (specifically 20.9 million) have achieved their vesting conditions but remain restricted for a period of time; and
- ▶ All the options could still vest in the event of a change in control of Xanadu. These are not triggered by a change in control of the Kharmagtai Project, only in the parent company.

### 5.3 Share trading data of Xanadu

#### 5.3.1 Share trading data

Figure 5.4 displays the daily volume weighted average price ('VWAP') and daily volume of Xanadu shares traded on the ASX over the period between 21 December 2022 and 31 January 2024.

**Figure 5.4: Daily VWAP and volume of Xanadu shares traded from 21 December 2022 to 31 January 2024**



Source: Capital IQ as at 31 January 2024

Over the period graphed in Figure 5.4 above, Xanadu's daily VWAP displays a period low of \$0.029 on 28 December 2022 and a period high of \$0.115 on 8 August 2023.

In addition to the share price and volume data of Xanadu shown above, we have also provided additional information in Table 5.6 below to assist readers to understand the possible reasons for the movement in Xanadu's share price over the period analysed.

The selected ASX announcement referenced in Table 5.6 below correspond to those displayed in Figure 5.4 above.

**Table 5.6: Selected Xanadu ASX announcements from 21 December 2022 to 31 January 2024**

Date	Announcement
21/12/2022	Xanadu announced the formalisation of the formation of the 50% JV for the Kharmagtai Project with Zijin. The deal saw Xanadu raise \$7.2 million via placement to Zijin and increased their stake to 19.99%.
22/12/2022	Xanadu announced a gas offtake memorandum of understanding with Jade Gas, under which Jade Gas will have the option to supply gas to Xanadu to power its Kharmagtai Project.
17/01/2023	Xanadu entered a trading halt pending an announcement.
18/01/2023	Xanadu announced a \$1.1 million placement issuing 41,887,844 new shares at \$0.027, which represents a 7% discount to the last closing price.
30/01/2023	Xanadu released its quarterly activities and cash flow report for the period ending 31 December 2022, highlighting the signing of a strategic partnership deal with Zijin during the quarter. The report also revealed that the company had just \$118,000 in cash at the end of the period.
10/03/2023	Xanadu announced that phase 2 and phase 3 of its strategic partnership with Zijin was complete, this provided Xanadu with funding for the Kharmagtai Project.

Date	Announcement
24/03/2023	Xanadu announced that Zijin has received regulatory approval from the Chinese government for the strategic partnership between Xanadu and Zijin.
28/04/2023	Xanadu released their quarterly activities and cashflows report for the period ending 31 March 2023, wherein they provided an update on the JV and share placement with Zijin and an overview of the cashflow for the quarter.
16/05/2023	Xanadu released their first quarter 2023 financial statements and management's discussion and analysis report for the period ended 31 March 2023. This included an update on the financial position, financial performance and included an operational update.
23/05/2023	Xanadu announced an aggressive 18,000m growth and discovery drill programme and the Kharmagtai Project.
07/06/2023	Xanadu announced new higher-grade zones the White Hill Deposit and the Stockwork Hill deposit of the Kharmagtai Project, with several drill holes delivering grades materially better than the current resource grades of each deposit.
19/06/2023	Xanadu responded to an ASX price query, noting that the Company was not aware of any information concerning it that had not been announced which could explain the recent trading events.
19/07/2023	Xanadu announce that infill drilling at the White Hill Deposit defined a new zone of high-grade copper and gold mineralisation.
31/07/2023	Xanadu released their quarterly activities and cashflows report for the period ended 30 June 2023 in which they provided an summary of the key operational announcements throughout the quarter including the commencement of a full scale pre-feasibility programme at the Kharmagtai Project along with an update on their cash position.
09/08/2023	Xanadu announced new infill drilling at the Stockwork Hill deposit of the Kharmagtai Project which returned strong higher-grade results.
06/09/2023	Xanadu released their quarterly financial statements and management discussions for the period ended 30 June 2023, in which they disclosed their three and six month financial performance and provided an update on their projects highlights over the quarter.
04/10/2023	Xanadu provided an update on infill drilling at the White Hill deposit at the Kharmagtai Project, with updated drill hole results which demonstrated the potential to enhance the 2021 MRE.
26/10/2023	Xanadu announced that drilling had an intersected 205.3m at 0.44 g/t Au and 0.14% Cu from 37.7m new gold zone at the Golden Eagle Deposit of the Kharmagtai Project.
31/10/2023	Xanadu released their quarterly activities and cashflows report for the period ended 30 September 2023. They provided an update on the pre-feasibility programme and discovery exploration activities of the Kharmagtai Project and a reported net decrease in cash for the period.
16/11/2023	Xanadu entered a trading halt pending the release of an announcement.
16/11/2023	Xanadu released an update on the discovery drilling at the Kharmagtai Project which intersected mineralisation across multiple largely unexplored porphyry clusters, including high density stockwork, breccia and gold only mineralisation.
20/11/2023	Xanadu announced a \$4.3 million placement totalling 78,181,818 shares issued at \$0.055 which represented a 19.1% discount to last closing price.
08/12/2023	Xanadu released an updated mineral resource estimate which increased the contained copper equivalent (CuEq) by 13% and included a 25% increase in the higher-grade component to 125Mt.
22/01/2024	Xanadu announced that they had agreed to earn up to an 80% interest in the Oytu and Sant Tolgoi projects.
30/01/2024	Xanadu announced their latest drilling results from the Kharmagtai Project, with a new higher grade copper and gold mineralisation at the White Hill deposit.
31/01/2024	Xanadu released their quarterly activities and cash flow report for the period ending 31 December 2023 summarising the key updates on the Kharmagtai Project resource and reporting an increase in cash due to the issue of new equity.
04/03/2024	Xanadu released an update on the sulphide rougher process recoveries at the Kharmagtai Project, with rougher flotation tests delivering recovering up to 98% copper and 95% gold at head grades up to 1.6% Cu and 2.0 g/t Au.
06/03/2024	Xanadu released an update on the metallurgical test work for the Kharmagtai Project, with recent column leaching tests on the mineralised oxide portion of Kharamagtai Project, with metallurgical extraction peaking at 93% copper and 46% gold.
23/04/2024	Xanadu provided an update on metallurgical test work for the Kharmagtai Project, noting up to 95% copper and 92% gold recovered in the hydrofloat stage.
29/04/2024	Xanadu released their quarterly activities and cash flow report for the period ending 31 March 2024. They provided an update on both the Red Mountain and Kharamgtai projects and reported a net increase in cash driven by the issue of equity securities.
21/06/2024	Xanadu announced near surface coper and gold results from all four prospects at the Red Mountain project, with the best intersections returning 41m at 1.07 g/t Au from 32m and 8m at 1.00% Cu and 0.12g/t Au from 267m.
31/07/2024	Xanadu released their quarterly activities and cash flow report for the period ending 30 June 2024. They provided updates on their existing projects and cash position. Most notably they provided an update on the Red Mountain project.
21/08/2024	Xanadu announced an increase in the mineral resource estimate for the Kharmagtai Project. Which increased the contained copper by 14% and contained gold by 9%.
10/09/2024	Xanadu announced that field operations are underway at the Sant Tolgoi Copper-Nickel project.
18/09/2024	Xanadu announced pre-feasibility metallurgical test work results for the Kharamgtai Project, which included recoveries of approximately 81% copper and 80% gold from sulphide feed.

Date	Announcement
14/10/2024	Xanadu released a maiden ore reserve & updated mineral resource update for the Kharmagtai Project which increased the contained copper and gold in the project from 3.8 Mt to 4.7 Mt and from 9.3 Moz to 11Moz respectively.
14/10/2024	Xanadu released a pre-feasibility study relating to the Kharmagtai Project, noting a post-tax NPV of \$930 million and mine life on 29 years.
14/10/2024	Xanadu announced a trading halt pending an announcement.
31/10/2024	Xanadu released its quarterly activities and cash flow report for the period ending 30 September 2024, including updates on existing projects and its cash position. Notably, the report featured an updated NPV for the Kharmagtai Project based on the revised mineral resource estimate.
01/11/2024	Xanadu entered into a trading halt pending the release of an announcement.
05/11/2024	Xanadu announced a \$5.5 million placement at \$0.055 per share, reflecting a 14.1% discount to its most recent closing price before the announcement.
14/11/2024	Xanadu announced that it had expanded its placement originally announced on 4 November 2024 from \$5.5 million to \$7.5 million on the same terms.
31/01/2025	Xanadu released their quarterly activities and cash flow report for the period ending 31 December 2024. They provided updates on their existing projects and cash position. Most notably, they delivered a PFS and Maiden Ore Reserve for the Kharmagtai Project and transitioned operatorship to Zijin.

Source: Xanadu ASX Announcements

### 5.3.2 Liquidity of Xanadu shares on the ASX

The rate at which equity instruments are traded is generally referred to as the ‘liquidity’ of the equity instruments. Changes in liquidity may impact the trading price of equity instruments. This is particularly dependent on the number of equity instruments required to be bought and/or sold and the time period over which the equity instrument holder needs to buy and/or sell those equity instruments. Depending on the circumstances, a movement in market price may or may not represent a shift in value of either the equity instruments or a shift in value of the company to which the equity instruments relate as a whole.

Table 5.7 summarises the monthly liquidity of Xanadu shares from 1 January 2024 until 31 January 2025. Liquidity has been summarised by considering the following:

- ▶ Volume of Xanadu share trades per month;
- ▶ Value of total trades in Xanadu shares per month;
- ▶ Number of Xanadu shares traded per month as a percentage of total Xanadu shares outstanding at the end of the month;
- ▶ The monthly low daily VWAP and high daily VWAP of the Company; and
- ▶ Volume weighted average price per month.

**Table 5.7: Liquidity of Xanadu shares on the ASX**

Month	Volume	Shares Outstanding	Volume / Shares Outstanding	Monthly Low Share Price (\$)	Monthly VWAP (\$)	Monthly High Share Price (\$)
January 2025	19,779,240	1,907,146,980	1.04%	0.045	0.047	0.050
December 2024	33,229,860	1,855,425,010	1.79%	0.047	0.050	0.055
November 2024	77,021,620	1,811,269,170	4.25%	0.049	0.053	0.057
October 2024	59,380,350	1,716,006,010	3.46%	0.060	0.069	0.078
September 2024	32,541,770	1,716,006,010	1.90%	0.050	0.056	0.066
August 2024	26,674,410	1,716,006,010	1.55%	0.055	0.057	0.06
July 2024	23,710,590	1,716,006,010	1.38%	0.055	0.058	0.06
June 2024	18,910,480	1,716,006,010	1.10%	0.053	0.058	0.066
May 2024	37,992,360	1,716,006,010	2.21%	0.062	0.068	0.077
April 2024	61,792,410	1,716,006,010	3.60%	0.064	0.072	0.079
March 2024	63,277,250	1,715,246,740	3.69%	0.040	0.049	0.066
February 2024	41,914,850	1,700,820,680	2.46%	0.039	0.043	0.052
<b>Total</b>	<b>496,225,190</b>	<b>1,748,856,260</b>	<b>28.37%</b>	<b>0.039</b>	<b>0.058</b>	<b>0.079</b>

Source: Capital IQ as at 31 January 2025

Assuming a weighted average number of 1,748,856,260 Xanadu shares on issue over the period, approximately 28.37% of the total shares on issue were traded over the period 1 February 2024 and 31 January 2025. In our view, this indicates that Xanadu shares display a moderate level of liquidity.

### 5.4 Historical financial information of Xanadu

This section sets out the historical financial information of Xanadu. As this Report contains only summarised historical financial information, we recommend that any user of this Report read and understand the additional notes and

financial information contained in Xanadu's annual reports, including the full Statements of Profit or Loss and Other Comprehensive Income, Statements of Financial Position and Statements of Cash Flows.

Xanadu's full-year financial statements have been audited, and its half-year financial statements reviewed, by Ernst & Young. BDOCF has not performed any audit or review of any type on the historical financial information of Xanadu and we make no statement as to the accuracy of the information provided. However, we have no reason to believe that any of the information provided is false or misleading.

In financial year ('FY') 2023 Xanadu recorded a net loss of \$7.6 million, net cash outflows from operating activities of \$3.7 million and a cash balance of \$7.3 million at the reporting date of 31 December 2023. In H1 FY24, Xanadu recorded a net loss of \$3.0 million, net cash outflows from operating activities of \$1.6 million and a cash balance of \$5.2 million at the reporting date of 30 June 2024. Despite the continued net loss and reduced cash balance, Management believes that there are reasonable grounds to believe that Xanadu will continue as a going concern considering the following factors:

- ▶ Xanadu's past success in raising equity funds in capital markets;
- ▶ The potential to raise capital in debt markets on the basis of the Kharmagtai PFS outcomes if Xanadu chooses not to sell all its interest in Khuiten;
- ▶ Entering into farm-out, sell down or JV agreements at Red Mountain in order to continue to advance the project through further exploration work;
- ▶ The deferral of discretionary corporate operating and administrative costs and exploration expenditures; and
- ▶ Exercising one of the put options under the Khuiten JV Agreement to sell 100% of Xanadu's remaining ownership in Khuiten to Zijin for US\$50 million or 50% for US\$25 million; available for a 6 month period commencing on the date of PFS Delivery which is 14 October 2024.

Ernst & Young's Interim H1 FY24 review conclusion includes reference to a material uncertainty related to going concern but, ultimately, Ernst & Young noted that their review conclusion is not modified in respect of this matter.

#### 5.4.1 Statements of profit or loss and other comprehensive income

Table 5.8 summarises the consolidated statement of profit or loss and other comprehensive income of Xanadu for the 12 month periods ended 31 December 2021, 2022, 2023 and 6 month period ended 30 June 2024.

**Table 5.8: Xanadu's consolidated statement of profit or loss and other comprehensive income**

AUD (\$'000)	Ref	12 Months Ended 31 December 2021 Audited	12 Months Ended 31 December 2022 Audited	12 Months Ended 31 December 2023 Audited	6 Months Ended 30 June 2024 Reviewed
Gain on de-consolidation of subsidiary	A	-	-	1,155	-
Other income	B	1	61	3,013	1,940
<b>Total other income</b>		<b>1</b>	<b>61</b>	<b>4,168</b>	<b>1,940</b>
<b>Expenses</b>					
Other expenses	C	(3,450)	(4,483)	(7,670)	(3,197)
Share based payment expense	D	(815)	(397)	(1,523)	(459)
Exploration and evaluation		-	-	-	(117)
Depreciation and amortisation expenses		(55)	(69)	(64)	(39)
Finance costs		(35)	(36)	(77)	(16)
Loss on disposal of assets		-	-	-	(11)
Share of loss of a JV	E	-	-	(2,412)	(1,115)
Impairment of exploration and evaluation assets	F	(4,637)	-	-	-
<b>Loss before income tax expense from continuing operations</b>		<b>(8,991)</b>	<b>(4,924)</b>	<b>(7,578)</b>	<b>(3,014)</b>
Income tax expense		-	-	-	-
<b>Loss after income tax expense from continuing operations</b>		<b>(8,991)</b>	<b>(4,924)</b>	<b>(7,578)</b>	<b>(3,014)</b>
Loss after income tax expense from discontinued operations	G	(127)	(167)	-	-
<b>Loss after income tax expense for the year</b>		<b>(9,118)</b>	<b>(5,091)</b>	<b>(7,578)</b>	<b>(3,014)</b>
<b>Other comprehensive income</b>					
Foreign currency translation		2,681	(5,378)	(329)	570
Foreign currency translation reclassified to profit or loss	A	-	-	12,508	-
Share of other comprehensive loss of a JV	E	-	-	(18)	1,357
<b>Other comprehensive income for the year, net of tax</b>		<b>2,681</b>	<b>(5,378)</b>	<b>12,161</b>	<b>1,927</b>

Total comprehensive income for the year	(6,437)	(10,469)	4,583	(1,087)
---	---------	----------	-------	---------

Source: Xanadu Annual Reports FY22 and FY23, and Interim Report FY24

### Notes to Table 5.8

A	<ul style="list-style-type: none"> <li>▶ In FY22, Xanadu entered into a series of agreements with Zijin to issue new shares, increasing Zijin's ownership in Khuiten, the owner of Xanadu's Kharmagtai Project, to 50%. The transaction was completed on 10 March 2023, following regulatory approval. Upon completion, Xanadu de-consolidated Khuiten, recognising a gain of AU\$1.2 million in FY23. This gain represents the difference between the fair value of the consideration received, the fair value of the retained interest, and the carrying value of the net assets derecognised.</li> <li>▶ As part of the de-consolidation in FY23, AU\$12.5 million previously recognised in the foreign currency translation reserve was reclassified to profit and loss. This adjustment reflects the transfer of accumulated foreign exchange differences, previously recorded in equity, to the income statement upon the disposal of the subsidiary.</li> <li>▶ The gain on de-consolidation and the reclassification of foreign currency reserves significantly impacted Xanadu's FY23 total comprehensive income.</li> </ul>
B	<ul style="list-style-type: none"> <li>▶ Other income includes operator overhead, rental income, interest income, and net gains on the disposal of property, plant, and equipment.</li> <li>▶ In FY23, with the inception of the Khuiten JV, Xanadu began receiving operator overhead and rental income. These were the primary components of other income, totalling AU\$3.0 million in FY23 and AU\$1.9 million H1 FY24. This income reflected Xanadu's role as operator of the JV and covers costs associated with the motor vehicle fleet used for the project.</li> <li>▶ Under the terms of the Khuiten JV shareholders agreement, the operator is entitled to recover overhead costs incurred. Xanadu managed the JV from its inception until 10 September 2024, when the transition of operatorship to Zijin commenced. From this date, Xanadu will no longer be entitled to operator overhead recoveries.</li> </ul>
C	<ul style="list-style-type: none"> <li>▶ Other expenses include administration expenses, wages and management fees, consulting fees, and net foreign currency gains and losses.</li> <li>▶ Other expenses increased from AU\$3.5 million in FY21 to AU\$7.7 million in FY23, primarily as FY23 incurred extra costs in relation to the Khuiten JV transaction and promotion, including legal, marketing, audit and mining conference expenses.</li> </ul>
D	<ul style="list-style-type: none"> <li>▶ The share-based payments expense relates to the issuance of unlisted options to key management personnel as part of remuneration packages.</li> <li>▶ The Xanadu Equity Incentive Plan was approved by shareholders at the Company's 2020 Annual Greeting Meeting, with additional vesting conditions approved by shareholders during the 23 December 2020 Extraordinary General Meeting. Under the plan, the Board may grant options and share rights over ordinary shares in the Company to certain key management personnel of the Company. The share rights are issued for nil consideration and are granted in accordance with performance guidelines established by the Board. The options were granted in the period from 2021 to 2024.</li> <li>▶ In FY23, 85.5 million options were granted, 4.6 million exercised, and 3.0 million expired, leaving a total of 124.9 million options outstanding. The share-based payment expense increased significantly, rising from AU\$0.4 million in FY22 to AU\$1.5 million in FY23, driven by the additional options issued to management.</li> </ul>
E	<ul style="list-style-type: none"> <li>▶ In FY23, following the transaction with Zijin, Xanadu lost control of Khuiten. From 10 March 2023, Xanadu's remaining 50% interest in Khuiten has been accounted for using the equity method in the consolidated financial statements.</li> <li>▶ The share of other comprehensive loss from the JV reflects the foreign currency translation gain or loss recognised for the JV.</li> </ul>
F	<ul style="list-style-type: none"> <li>▶ In FY21, an impairment loss of Exploration and Evaluation ('E&amp;E') assets for AU\$4.6 million was recognised. This impairment related to the Red Mountain exploration asset and was triggered by the exit of the Japan Oil Gas and Metals National Corporation ('JOGMEC') from a joint exploration agreement.</li> </ul>
G	<ul style="list-style-type: none"> <li>▶ Xanadu classified the assets and liabilities of Khuiten as held for sale at 31 December 2022, with the transaction completing on 10 March 2023. This classification reflects that the disposal of Khuiten represents the divestment of a separate major line of business for Xanadu, significantly altering the composition of the Group's operations.</li> <li>▶ The transaction resulted in Khuiten being treated as a discontinued operation in the consolidated financial statements, as it constitutes a distinct and significant component of Xanadu that has been disposed of.</li> </ul>

For personal use only

## 5.4.2 Statements of financial position

Table 5.9 summarises Xanadu's statements of financial position as at 31 December 2021, 2022, 2023 and 30 June 2024.

**Table 5.9: Xanadu's summarised consolidated statements of financial position**

AUD (\$'000)	Ref	As at 31 December 2021 Audited	As at 31 December 2022 Audited	As at 31 December 2023 Audited	As at 30 June 2024 Reviewed
<b>Current assets</b>					
Cash and cash equivalents	A	3,321	61	7,324	5,238
Other receivables		86	52	506	113
Prepayments and other assets		15	-	-	-
Assets of disposal groups classified as held for sale	B	-	42,803	-	-
<b>Total current assets</b>		<b>3,422</b>	<b>42,916</b>	<b>7,830</b>	<b>5,351</b>
<b>Non-current assets</b>					
Investments accounted for using the equity method	B	-	-	50,608	50,850
Property, plant and equipment		559	84	212	192
Right-of-use assets		323	401	271	259
Deferred exploration and evaluation expenditure	C	50,328	6,975	7,193	8,478
<b>Total non-current assets</b>		<b>51,210</b>	<b>7,460</b>	<b>58,284</b>	<b>59,779</b>
<b>Total assets</b>		<b>54,632</b>	<b>50,376</b>	<b>66,114</b>	<b>65,130</b>
<b>Current liabilities</b>					
Trade and other payables	D	253	95	1,481	264
Employee benefits		9	17	107	144
Lease liabilities		40	67	61	53
Liabilities directly associated with assets of disposal groups classified as held for sale	B	-	32	-	-
<b>Total current liabilities</b>		<b>302</b>	<b>211</b>	<b>1,649</b>	<b>461</b>
<b>Non-current liabilities</b>					
Employee benefits		-	-	62	79
Lease liabilities		192	256	134	114
<b>Total non-current liabilities</b>		<b>192</b>	<b>256</b>	<b>196</b>	<b>193</b>
<b>Total liabilities</b>		<b>494</b>	<b>467</b>	<b>1,845</b>	<b>654</b>
<b>Net assets</b>		<b>54,138</b>	<b>49,909</b>	<b>64,269</b>	<b>64,476</b>
<b>Equity</b>					
Issued capital		145,659	151,671	163,083	163,918
Reserves	B	(3,580)	(8,431)	5,334	7,720
Accumulated losses		(92,005)	(96,570)	(104,148)	(107,162)
Non-controlling interest	B	4,064	3,239	-	-
<b>Total equity</b>		<b>54,138</b>	<b>49,909</b>	<b>64,269</b>	<b>64,476</b>

Source: Xanadu Annual Reports FY22 and FY23, and Interim Report FY24

### Notes to Table 5.9

<b>A</b>	<ul style="list-style-type: none"> <li>Cash and cash equivalents increased between FY21 and FY23 due to the issue of new capital. However, In FY24 cash and cash equivalents decreased due to operational funding requirements. Section 5.4 details Management's basis for assessing Xanadu as a going concern, including funding options and cost management strategies. Ernst &amp; Young considered these factors and did not modify their review conclusion despite noting a material uncertainty.</li> </ul>
<b>B</b>	<ul style="list-style-type: none"> <li>In FY22, Xanadu entered into a series of agreements with Zijin to issue new shares, increasing Zijin's ownership in Khuiten to 50%.</li> <li>As of 31 December 2022, Xanadu reclassified AU\$42.8 million of assets, AU\$32k of liabilities, AU\$11.7 million in foreign currency translation reserves, and AU\$3.2 million in non-controlling interest related to Khuiten as held for sale.</li> <li>In FY23, following the transaction with Zijin, Xanadu lost control of Khuiten. From 10 March 2023, Xanadu's remaining 50% interest in Khuiten has been accounted for using the equity method in the consolidated financial statements. As set out in the table above, Xanadu's 50% share in the Khuiten JV was initially recognised at a value of approximately AU\$50 million.</li> </ul>
<b>C</b>	<ul style="list-style-type: none"> <li>Xanadu capitalises E&amp;E expenditure as an asset when tenure rights are current, and recovery is expected through successful development, sale, or ongoing exploration. If significant uncertainty arises about recoverability, the asset is impaired in the year the decision is made.</li> </ul>

- ▶ In FY21, an impairment of AU\$4.6 million was recognised for the Red Mountain project, triggered by the exit of JOGMEC from a joint exploration agreement.
- ▶ In FY22, the deferred E&E for Khuiten was recognised as held for sale, as mentioned in point B. Following the transaction with Zijin, Xanadu ceased consolidating E&E costs, instead accounting for Khuiten JV results through the equity method. Deferred E&E expenditure beyond this period reflects Red Mountain only.
- ▶ As of H1 FY24, capitalised Red Mountain expenditure, net of AU\$5.8 million in accumulated impairments, totalled AU\$5.5 million. Impairments were recognised in Mongolian currency and vary with the exchange rate.

D

- ▶ Trade and other payables consist of trade payables, accrued expenses, and other payables. These liabilities are non-interest-bearing and are typically settled within 30 days.
- ▶ Between FY21 and H1 FY24, Xanadu's trade and other payables fluctuated, notably in FY22 to AU\$1.5 million, decreasing to AU\$0.3 million in FY24.

### 5.4.3 Statements of cash flows

Table 5.10 summarises Xanadu's Statement of Cash Flows for the 12 month periods ended 31 December 2021, 2022, 2023 and 6 month period ended 30 June 2024.

Table 5.10: Xanadu's summarised consolidated statements of cash flows

AUD (\$'000)	Ref	12 Months Ended 31 December 2021 Audited	12 Months Ended 31 December 2022 Audited	12 Months Ended 31 December 2023 Audited	6 Months Ended 30 June 2024 Reviewed
<b>Cash flows from operating activities</b>					
Payments to suppliers and employees	A	(3,618)	(4,761)	(6,672)	(3,570)
Receipts from JV	B	-	-	3,004	1,862
Interest received		1	41	9	78
Interest and other finance costs paid		(35)	(44)	(77)	(13)
<b>Net cash used in operating activities</b>		<b>(3,652)</b>	<b>(4,764)</b>	<b>(3,736)</b>	<b>(1,643)</b>
<b>Cash flows from investing activities</b>					
Payments for property, plant and equipment		(422)	(9)	(66)	-
Payments for exploration and evaluation expenditure	C	(9,529)	(3,772)	(220)	(1,237)
Payments for exploration and evaluation on behalf of JOGMEC	D	(2,082)	-	-	-
Proceeds from JOGMEC Red Mtn earn-in payments	D	1,776	-	-	-
Proceeds from JOGMEC Red Mtn option payments capitalised	D	162	-	-	-
Proceeds from disposal of property, plant and equipment		-	33	-	-
Payments for additional investment in subsidiary		(477)	-	-	-
<b>Net cash used in investing activities</b>		<b>(10,572)</b>	<b>(3,748)</b>	<b>(286)</b>	<b>(1,237)</b>
<b>Cash flows from financing activities</b>					
Net Proceeds from issue of shares	E	9,531	5,560	11,412	835
Repayment of lease liabilities		(49)	(50)	(127)	(29)
<b>Net cash used in financing activities</b>		<b>9,482</b>	<b>5,510</b>	<b>11,285</b>	<b>806</b>
<b>Net decrease in cash and cash equivalents</b>	F	<b>(4,742)</b>	<b>(3,002)</b>	<b>7,263</b>	<b>(2,074)</b>
Cash and cash equivalents at the beginning of the financial year		7,687	3,321	61	7,324
Effects of exchange rate changes on cash and cash equivalents		376	(201)	-	(12)
<b>Cash and cash equivalents at the end of the financial year</b>		<b>3,321</b>	<b>118</b>	<b>7,324</b>	<b>5,238</b>

Source: Xanadu Annual Reports FY22 and FY23, and Interim Report FY24

**Notes to Table 5.10**

<b>A</b>	<ul style="list-style-type: none"> <li>▶ Xanadu has consistently had cash outflows from operations, as payments to suppliers and employees exceed income generated, which is typical for a mining explorer. Section 6.5 details Management’s basis for assessing Xanadu as a going concern, including funding options and cost management strategies. Ernst &amp; Young considered these factors and did not modify their review conclusion despite noting a material uncertainty.</li> </ul>
<b>B</b>	<ul style="list-style-type: none"> <li>▶ Receipts from the Khuiten JV were AU\$3.0 million in FY23 and AU\$1.9 million in H1 FY24, representing operator overhead and rental income.</li> </ul>
<b>C</b>	<ul style="list-style-type: none"> <li>▶ In FY22, Xanadu recorded E&amp;E outflows of AU\$3.8 million, with AU\$2.8 million allocated to Kharmagtai and AU\$1.0 million to Red Mountain.</li> <li>▶ The reduction in outflows from FY23 to H1 FY24 is due to the Khuiten JV being accounted for under the equity method.</li> <li>▶ In FY23, cash outflows were directed to Red Mountain, with AU\$0.2 million in FY23 and AU\$1.2 million in H1 FY24. Exploration was limited in FY23 due to operational reasons, with activities set to resume in FY24.</li> </ul>
<b>D</b>	<ul style="list-style-type: none"> <li>▶ In March 2020, Xanadu entered into an earn-in agreement with JOGMEC to fund up to AU\$7.1 million in exploration over four years for a 51% interest in the Red Mountain project. The agreement was terminated in November 2021 before the earn-in conditions were met.</li> <li>▶ In FY21, cash flows included payments for exploration expenditure on behalf of JOGMEC, along with proceeds received from JOGMEC.</li> </ul>
<b>E</b>	<ul style="list-style-type: none"> <li>▶ In FY21, Xanadu raised AU\$9.5 million (net of costs) by issuing 163.8 million shares at AU6.2 cents per share.</li> <li>▶ In FY22, Xanadu raised AU\$5.6 million by issuing 139.0 million shares to Zijin at AU4.0 cents per share under Phase 1 of the investment agreement.</li> <li>▶ In FY23, Xanadu raised AU\$11.4 million (net of costs) through two equity placements and Phase 2 of the Zijin agreement, issuing 284.0 million shares.</li> <li>▶ In H1 FY24, Xanadu raised AU\$0.8 million by issuing 15.2 million shares at AU5.5 cents per share.</li> </ul>
<b>F</b>	<ul style="list-style-type: none"> <li>▶ Between FY21 and H1 FY24, Xanadu operated with net cash outflows from operating and investing activities. These outflows were funded through share issuances in each period.</li> </ul>



## 6.0 Industry Overview

Xanadu’s largest asset is its economic ownership of 38.25% of the Kharmagtai copper-gold project, which the Proposed Transaction relates to. This section is an overview of the copper and gold industry globally.

The information presented in this section has been compiled from a range of publicly available sources, together with information taken from various databases to which we subscribe. BDOCF has not independently verified any of the information and we recommend that users of this Report refer to the original source of any information listed in this section. This section should be referred to as a guide only.

### 6.1 Copper

#### 6.1.1 Overview

Copper is a soft, malleable, ductile metal used primarily for its electrical and thermal conductive properties and corrosion resistance. After iron and aluminium, it is the third most consumed industrial metal worldwide.<sup>8</sup> Similar to other metals, primary production is the output from ores, and secondary production is produced from recycled scrap. Copper is one of the most recycled metals because recycling extends the efficiency of use, resulting in energy savings and contributing to a sustainable source of metal for future generations.<sup>9</sup> Further, the metal is one of the few raw materials which can be recycled repeatedly without any loss of performance; primary and secondary copper can be used interchangeably.<sup>10</sup>

Copper is highly versatile with various applications across many industries, including construction, communication, equipment, transport and infrastructure. Due to its ability to conduct heat and electricity, it is widely used in electronic devices and electrical wiring. For example, renewable energy sources such as solar, wind, geothermal, fuel cells and other technologies are all heavily reliant on copper due to its excellent conductivity.<sup>11</sup> Another use of copper is in the semiconductor industry where it is used for circuitry in silicon chips. Not only are copper wires more durable and reliable, but they also conduct electricity with about 40% less resistance than aluminium wires - resulting in an additional 15% burst in microprocessor speed.<sup>12</sup>

#### 6.1.2 Global Demand for Copper

According to statistics from the International Copper Study Group (‘ICSG’), global usage of refined copper grew from approximately 18.6 million tonnes in 2009 to 26.6 million tonnes in 2023.<sup>13</sup> This growth in demand is expected to be supported by existing uses for its transmission of electricity such as in industries involving construction and electronics. Other factors that will drive demand are population growth, product innovation and economic development. McKinsey & Company forecasts that annual copper demand will grow to 36.6 million metric tonnes by 2031.<sup>14</sup>

Figure 6.1 set out below shows the distribution of total refined copper imports in 2023. China dominates as the largest importer, bringing in over US\$32.2 billion worth of refined copper. The United States follows with US\$6.8 billion, and Italy ranks third at US\$5.2 billion. The remaining countries collectively account for 42% of the total imports.

Figure 6.1: Percentage share of total refined copper imports in 2023<sup>15</sup>

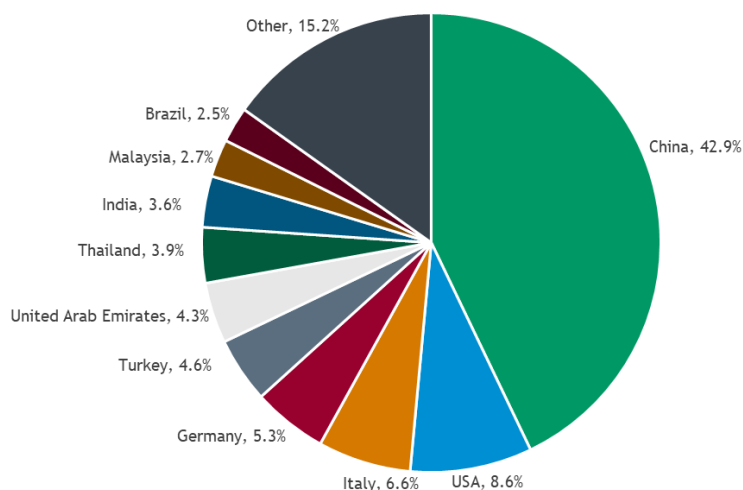

Source: Trend Economy

<sup>8</sup> “Copper Statistics and Information”, U.S. Geological Survey

<sup>9</sup> “Copper Recycling”, International Copper Study Group 2024

<sup>10</sup> “Copper Recycling”, International Copper Association 2022

<sup>11</sup> “Mineral requirements for clean energy transitions”, International Energy Agency 2021

<sup>12</sup> “Copper interconnects”, IBM

<sup>13</sup> “The World Copper Factbook 2024”, International Copper Study Group, 2024

<sup>14</sup> “Bridging the copper supply gap”, McKinsey & Company, 17 February 2023

<sup>15</sup> “Refined Copper Imports and Exports 2023”, Trend Economy, 7 November 2024

### 6.1.3 Global Supply for Copper

According to the US Geological Survey, the global mine production of copper has increased from 15.9 million tonnes in 2010 to 22.4 million tonnes in 2023. The ratio between production and capacity is called the capacity utilisation rate and in 2023, the global copper mining capacity utilisation rate was around 81.4%. This implies a total copper mining capacity of 27.5 million tonnes, which is estimated to increase by 1.7% in 2024 and 3.5% in 2025.<sup>16</sup>

The oceans represent around 70% of the world’s surface, and the ocean floor is believed to contain important mineral resources, including copper.<sup>17</sup> In order to meet increasing copper demand, seafloor deposits could represent an important opportunity for additional supply. However, the challenge is to be able to extract these ores while respecting all environmental standards and turning them into sustainable operations.

Table 6.1 below shows the breakdown of global mined copper production by the top six countries in 2022, recent trends in their production from 2022, and their forecasted production for 2023. In 2022, Chile was the largest producer, accounting for 24% of all mined copper production worldwide, followed by Peru, which accounted for 11%. Copper production in Congo has ramped up due to investment from Chinese companies, with a further \$7 billion of investment from Chinese construction companies expected in Congo as a part of copper mines.<sup>18</sup>

**Table 6.1: Global mined production**

'000 tonnes	2020	2021	2022	2023 (estimate)	CAGR (%)
Chile	5,730	5,620	5,330	5,000	-3.35%
Peru	2,150	2,300	2,450	2,600	4.87%
China	1,720	1,910	1,940	1,700	-0.29%
Congo (Kinshasa)	1,600	1,740	2,350	2,500	11.80%
United States	1,200	1,230	1,230	1,100	-2.15%
Australia	885	813	819	810	-2.19%
Other countries	7,271	7,587	7,781	8,290	3.33%
<b>World total (rounded)</b>	<b>20,600</b>	<b>21,200</b>	<b>21,900</b>	<b>22,000</b>	<b>1.66%</b>

Source: US Geological Survey

In the 2024 Copper Mineral Commodity Summary by the Geological Survey, global copper reserves are estimated to total 1 billion metric tonnes. A 2015 survey estimated that undiscovered resources contained an estimated 3.5 billion tons. Collectively, Chile, Australia and Peru account for 42% of the global reserves.

The distribution of known reserves is depicted graphically in Figure 6.2 below.

**Figure 6.2: Distribution of known copper reserves**

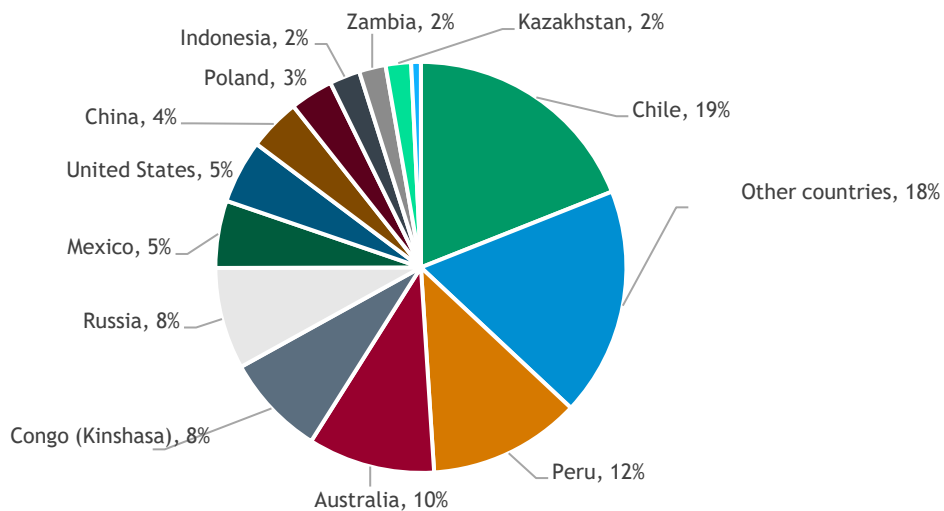

Source: US Geological Survey, Mineral Commodities Summaries 2024

<sup>16</sup> “Copper Market Forecast 2023/2025”, International Copper Study Group, 26 September 2024

<sup>17</sup> “An Overview of Seabed Mining Including the Current State of Development, Environmental Impacts, and Knowledge Gaps”, K.Miller et.al 2017

<sup>18</sup> “Chinese companies to invest up to \$7 billion in Congo mining infrastructure”, Reuters, 28 January 2024

### 6.1.4 Copper Prices

A COVID-19 induced economic slowdown decreased the global copper price to a 3-year low in late March 2020. Between this low and April of 2021, prices recovered quickly, supported by improving economic conditions and the ongoing Russia-Ukraine conflict. Throughout 2022, copper prices declined significantly, driven by a decline in demand from China due to the Chinese zero-COVID policy and high inflation rates within the US. In 2023, the price of copper rebounded due to a swell of green manufacturing and a supply shortage of 178,000 tonnes<sup>19</sup>. In 2024, copper prices reached record highs with The Commodity Exchange ('COMEX') price climbing to US\$5.11 per pound in Q2, driven by increased demand from sectors tied to the energy transition and expectations of tightening supply.

Figure 6.3 below shows the historical trading price for copper in the last 5 years based on the quoted price on the COMEX in USD per pound, as well as the forecasted spot price of copper to 2028 (in nominal terms, free on board).

**Figure 6.3: Historical copper prices and Consensus Economics forecast prices (in nominal terms)**

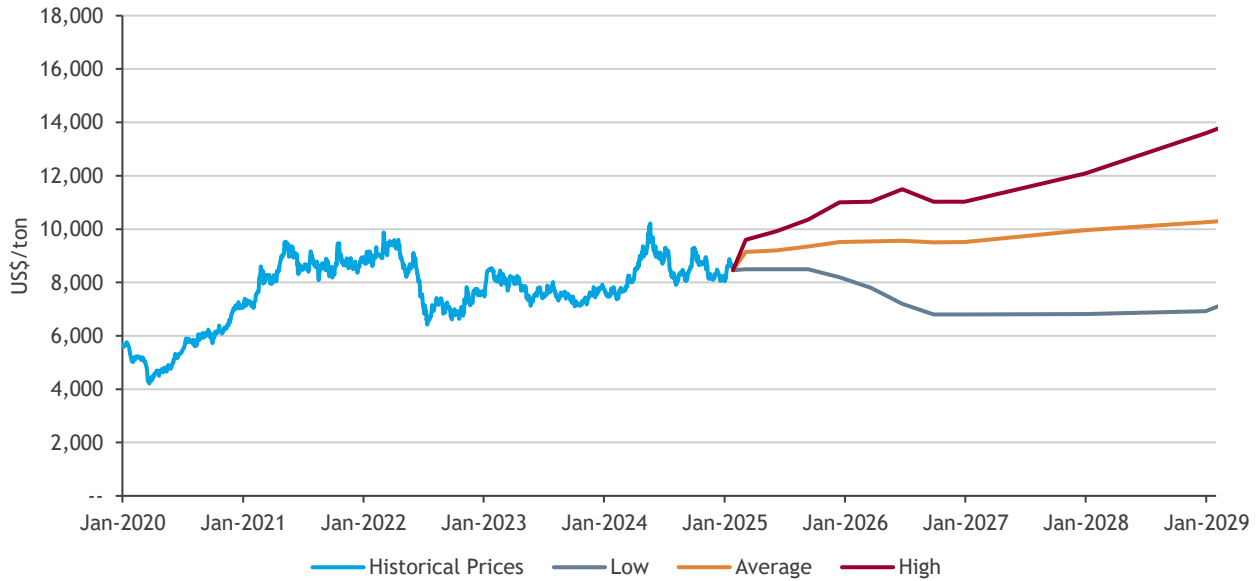

Source: Capital IQ - High Grade Copper (COMEX) (2 January 2020 to 27 January 2025), Consensus Economics January 2025 (Survey Date: 20 January 2025), BDOCF Analysis

### 6.1.5 Copper Outlook

Global demand for copper is expected to increase due to the development of renewable energy infrastructure and increased uptake of electric vehicles, two areas that require greater copper volumes than their fossil fuel counterparts.<sup>20</sup> In November 2023, Mongolia's Minister of Mining and Heavy Industries, Ganbaatar Jambal, stated that the country is currently exporting about 1.4 million tonnes of copper concentrate annually, with the potential to increase this to 2 to 2.5 million tonnes in the future.<sup>21</sup> The ICSG also expects sustained growth in copper demand as it remains an essential commodity to economic activity, particularly in today's technological society. This is because copper is the most widely used metal in energy generation, transmission infrastructure, and energy storage.<sup>22</sup>

### 6.1.6 Chinese Market

China has significant reliance on imported copper with 70% of their total copper sourced from overseas resources according to a Reuters report from November 2024.<sup>23</sup> According to a 2024 report by Wood Mackenzie, China's total copper mine output, including overseas mining assets, accounts for just 20% of global copper production. This is significantly lower than the country's share of global demand, which stands at 50%.<sup>24</sup> Further to this, Chinese mining enterprises have increasingly turned to overseas markets to secure near-production or at-production projects. This shift has been driven by an unexpected supply deficit in early 2024 and limited domestic resource availability.<sup>25</sup>

<sup>19</sup> "Review of important factors affecting the copper market in 2023", Shanghai Metals Market, 10 January 2024

<sup>20</sup> "Copper Ore Mining in Australia", IBIS World 2023

<sup>21</sup> "Interview, Ganbaatar Jambal", Global Business Reports, 27 November 2023

<sup>22</sup> "Copper Market Forecast 2023/2024", International Copper Study Group 2023

<sup>23</sup> "China should use more aluminium and recycled copper, industry says" Reuters, 13 November 2024

<sup>24</sup> "Securing copper supply, no China, no energy transition" Wood Mackenzie, August 2024

<sup>25</sup> "China Copper seeks to acquire overseas mines amid tight supply, chairman says" Mining.com, 11 March 2024

## 6.2 Gold

### 6.2.1 Overview

Gold is a ductile and malleable precious metal that provides a sustainable store of value because it does not corrode. The metal has been primarily used as money for exchange, as a store of value, and for valuable jewellery and other artefacts. Due to its properties, there are also many other uses. For example, its ability to conduct heat and electricity makes it highly suitable in modern electronics. Its resilience to corrosion makes it ideal as a coating for contacts and connections in electrical circuits. Further, its durability and non-toxic state make it a material of choice for implants in medicine and dentistry. Today, most of the world's gold is mined from large open-cut pits or extensive underground operations.

### 6.2.2 Global Demand for Gold

Ongoing demand for gold is derived from four core sectors: jewellery, investment, reserves, and technology. Technology is a growing segment and is closely related to advances in electronics and sensors including smartphones, nanotechnology, and drugs.

Figure 6.4 set out below illustrates the breakdown of global gold demand by sector from 2019 to Q3 2024. Between 2019 and Q3 2024, demand patterns across these sectors have shown notable shifts. Demand from central banks has increased in recent years, due to economic uncertainties and diversification strategies.

Figure 6.4: Breakdown of demand by sector

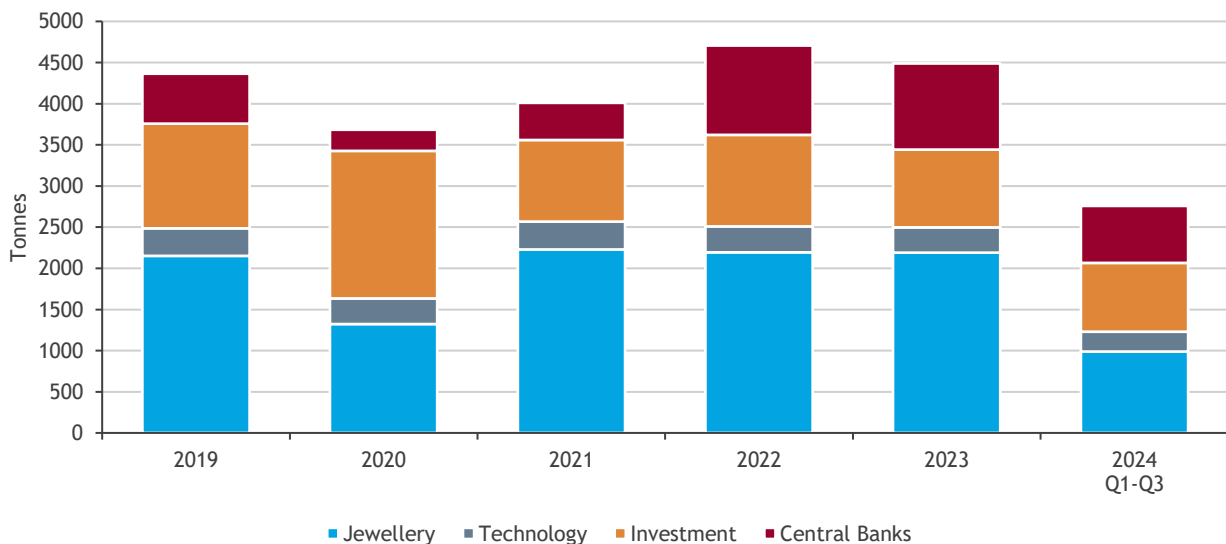

Source: World Gold Council

As gold carries no credit or counterparty risks, it is one of the most crucial reserve assets worldwide because it serves as a source of trust in a country and in all economic environments. Currently, central banks hold approximately 35,500 metric tons of the metal - about a fifth of all the gold ever mined.<sup>26</sup> One of gold's primary roles for central banks is to diversify their reserves since a nation's currency can swing in value depending on the perceived strength or weakness of the underlying economy.

### 6.2.3 Global Supply for Gold

Mine production accounts for approximately three-quarters of the gold supply each year with the remainder from recycling.<sup>27</sup> Due to the size and magnitude of mining operations, gold producing mines are slow to respond to commodity price changes. On the other hand, recycling is highly responsive to changes in price and economic shocks, 90% of recycled gold is made up from jewellery with the remainder being accounted for from technology.<sup>28</sup> The top five producers of gold are China, Australia, Russia, United States and Canada.<sup>29</sup>

Figure 6.5 illustrates the supply of gold from mine production and recycled gold from 2013 to 2023.

<sup>26</sup> "Central Banks Gold Reserves by Country", World Gold Council, 4 December 2024

<sup>27</sup> "Historical demand and supply", World Gold Council, 30 October 2024

<sup>28</sup> "Gold Supply", World Gold Council

<sup>29</sup> "Gold", US Geological Survey, January 2024

Figure 6.5: Global supply of gold

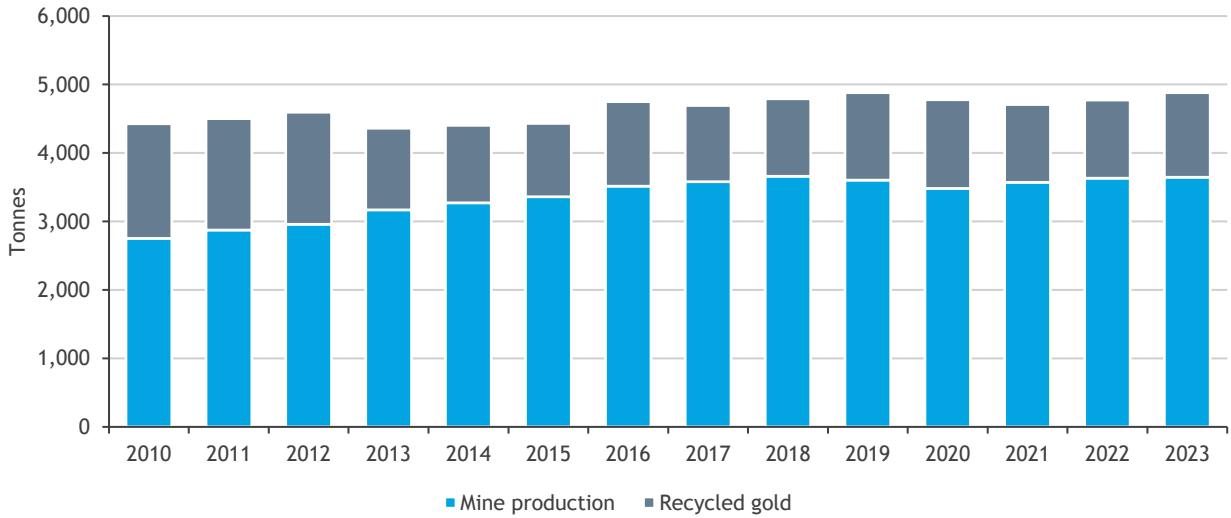

Source: World Gold Council

6.2.4 Gold Prices

Figure 6.6 below shows the historical trading price for gold in the last 5 years based on the quoted price on COMEX in USD per ounce, as well as the forecasted spot price of gold to 2028 (in nominal terms, free on board). We note that the ongoing impacts of the COVID-19 pandemic, coupled with persistent global inflationary pressures and the prolonged Russia-Ukraine conflict, have sustained high demand for gold, pushing prices to record levels in the years following 2020. Additionally, central bank purchases and fluctuating interest rate environments have further influenced price dynamics through to 2024.

Figure 6.6: Historical gold prices and Consensus Economics forecast prices (in nominal terms)

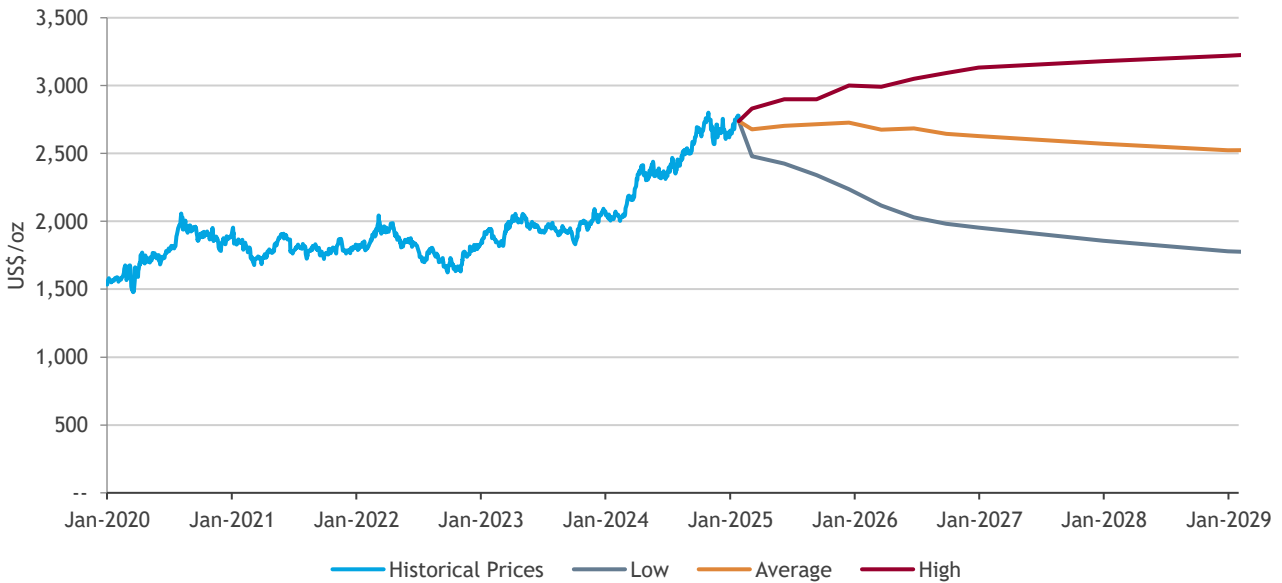

Source: Capital IQ - Gold (COMEX) (2 January 2020 to 27 January 2025), Consensus Economics January 2025 (Survey Date: 20 January 2025), BDOCF Analysis

For personal use only

#### 6.2.5 Gold Outlook

Movements in gold are typically correlated with economic downturns. Generally, there will always be demand for safe-haven assets, but during times of economic expansion, gold prices generally will decrease. Further, long-term gold price forecasts are often unpredictable because several factors need to be considered, such as mining supply or geopolitical tensions.

Gold is likely to remain an essential part of central bank reserves worldwide which can assist put a floor on prices while growing affluence in China is also likely to support demand. Despite the risk that changes in the global economy can cause short-term gold fluctuations, gold is forecasted to maintain its reputation as a portable store of value throughout Asia and other parts of the world.<sup>30</sup>

For personal use only

---

<sup>30</sup> "Gold Ore Mining in Australia", IBIS World, November 2024

## 7.0 Common Valuation Methodologies

### 7.1 Overview

RG 111 states that an expert should use its skill and judgment to select the most appropriate methodology or methodologies. The expert must have a reasonable (or tenable) basis for choosing its valuation methodologies. However, RG 111 does not prescribe which methodology should be used by the expert, but rather notes that the decision lies with the expert based on the expert's skill and judgement and after considering the unique circumstances of the securities or assets being valued.

For the purposes of this Report we have had regard to the International Valuation Standards published by the International Valuation Standards Council ('IVSC').

There are three overarching valuation methodologies described by the IVSC as follows:

- ▶ Income approach methods
- ▶ Market approach methods
- ▶ Cost approach methods.

### 7.2 Basis of value

The basis of valuation we have adopted is 'market value'. Market value is defined by the IVSC as:

*"...the estimated amount for which an asset or liability should exchange on the valuation date between a willing buyer and a willing seller in an arm's length transaction, after proper marketing and where the parties had each acted knowledgeably, prudently and without compulsion."*

The valuation work set out in this Report assumes this relationship.

### 7.3 Income approach

#### 7.3.1 Discounted cash flow ('DCF') method

The DCF method is widely used in cases where future cash flows, while uncertain, can be reasonably forecast based on available data, industry trends, or strategic projections. This approach is particularly applicable when an asset or business may experience initial cash outflows (e.g. during development or expansion phases) with anticipated positive cash flows in later years as it matures or achieves commercialisation. The DCF method captures these varying cash flow profiles by discounting projected future cash flows to present value, enabling a comprehensive valuation of entities with both stable and dynamic cash flow expectations.

The DCF method involves several key steps:

- ▶ Select the appropriate type of cash flow (e.g., pre-tax or post-tax, total cash flows or cash flows to equity, real or nominal) based on the nature of the subject asset.
- ▶ Determine the explicit forecast period, if applicable, over which cash flows will be projected. For assets at a stabilised level of growth and profits at the valuation date, an explicit forecast period may not be necessary, and a terminal value alone may form the basis of value (sometimes referred to as an income capitalisation method).
- ▶ Prepare cash flow projections for the explicit forecast period, aligning them with the asset's expected economic and operational performance.
- ▶ Calculate the terminal value, if appropriate, based on the asset's residual value or long-term growth rate beyond the forecast period.
- ▶ Determine the discount rate to reflect investor expectations of return, taking into account the specific risk characteristics of future cash flows and financing costs.
- ▶ Discount the projected cash flows and terminal value to present value using the selected discount rate.
- ▶ Adjust for non-operating assets or liabilities to ensure the final valuation reflects the entity's full financial position.

### 7.4 Market approach

#### 7.4.1 Guideline comparable method

The guideline comparable method is a common market approach that values an asset by reference to market-based metrics from comparable companies or transactions. This method is particularly applicable when there is reliable data on similar businesses or transactions in the relevant market.

The guideline comparable method involves several key steps:

- ▶ Identify relevant valuation metrics or comparable evidence that reflect how participants in the market value similar assets. Common metrics in business valuation include revenue, Earnings Before Interest, Taxes, Depreciation and Amortisation ('EBITDA'), Earnings Before Interest and Taxes ('EBIT'), net profit after tax ('NPAT'), and book values, with the choice depending on the industry and characteristics of the business.

- ▶ Select comparable publicly traded companies and relevant transactions, calculating key valuation metrics for each. When limited comparable information exists, we may also consider prices of similar businesses listed or offered for sale.
- ▶ Conduct a comparative analysis of qualitative and quantitative similarities and differences between the selected comparable companies and the subject asset to identify relevant adjustments.
- ▶ Make necessary adjustments to valuation metrics, if required, to account for differences between the subject asset and comparable companies (e.g. size, growth prospects, or risk profile).
- ▶ Apply the adjusted valuation metrics to the subject asset to arrive at an estimated value.

Additional adjustments may be appropriate to reflect differences between actual historical cash flows and those expected by a buyer on the valuation date.

Where earnings-based metrics (e.g. EBIT or EBITDA) are used for comparison, this is often referred to as the capitalisation of maintainable earnings ('CME') method.

#### 7.4.2 Share transactions

The share transactions approach values an entity based on recent transactions of its securities, providing an indication of market value when transaction data is available. This approach is particularly relevant in the following scenarios:

- ▶ For publicly traded entities, where share prices on an exchange can indicate market value, provided there is sufficient trading volume and a consistent trading history over time; and/or
- ▶ For entities with recent share issuances, such as rights issues or private placements, which can provide insight into the entity's perceived value.

Share market prices typically reflect transactions for minority interests and may not incorporate a premium for control.

#### 7.4.3 Industry specific metrics

Industry-specific valuation metrics can be relevant when market participants commonly rely on alternative measures of value specific to the industry. For resource companies, it is common for market analysts to have regard to multiples related to resources and tenement size.

### 7.5 Cost based method

#### 7.5.1 Replacement cost method

The replacement cost method values an asset based on the economic principle that a buyer would pay no more than the cost to acquire an asset with equivalent utility, either by purchase or by construction, assuming no undue time, inconvenience, or risk factors. This method calculates value by estimating the current replacement or reproduction cost of an asset and deducting allowances for physical deterioration and any other relevant forms of obsolescence.

The key steps in the replacement cost method are:

- ▶ Calculate all costs that a typical participant would incur to create or acquire an asset with equivalent utility.
- ▶ Assess depreciation due to physical, functional, or external obsolescence associated with the subject asset.
- ▶ Deduct total depreciation from the replacement cost to determine the asset's value.

When the replacement cost method is applied based on the book value of an entity's assets, it is often referred to as an asset based valuation ('ABV') methodology.

#### 7.5.2 Summation method

The summation method is useful for valuing entities whose overall value primarily depends on the individual values of different assets at various stages of development, or with different risk profiles.

The key steps in the summation method are:

- ▶ Value each component asset within the entity individually, using appropriate valuation approaches and methods for each type of asset.
- ▶ Aggregate the values of all component assets to determine the total value of the entity.



## 8.0 Valuation of Xanadu's Interest in the Khuiten JV prior to the Proposed Transaction

This section sets out our valuation of Xanadu's interest in the Khuiten JV and is structured as follows:

- ▶ Section 8.1 sets out our view of the most appropriate methodology to value Xanadu's interest in the Khuiten JV prior to the Proposed Transaction;
- ▶ Section 8.2 sets out an overview of the ERM Independent Technical Specialist Report;
- ▶ Section 8.3 sets out our cash flow assumptions in relation the Kharmagtai Project;
- ▶ Section 8.4 sets out our conversion of the Kharmagtai Project cashflows to the cashflows associated with Xanadu's interest in the Khuiten JV;
- ▶ Section 8.5 sets out our valuation of the Khuiten JV cashflows to Xanadu;
- ▶ Section 8.6 sets out our valuation of Xanadu's interest in the Khuiten JV; and
- ▶ Section 8.7 sets out our consideration of the share transaction valuation methodology.

### 8.1 Our valuation approach in relation to Xanadu's interest in the Khuiten JV prior to the Proposed Transaction

#### 8.1.1 Overview

We have considered each of the valuation methodologies outlined in Section 7 above and, in our view, it is appropriate to value Xanadu's interest in the Khuiten JV prior to the Proposed Transaction with reference to the summation method. We consider this method appropriate as Xanadu's interest in the Khuiten JV is derived from multiple assets including cashflows incorporated in the Financial Model, mineral resources outside of the Financial Model and other assets. The summation method provides the flexibility to value each asset having regard to their individual characteristics.

We have also considered a valuation approach based on recent share transactions in Xanadu. We discuss each of these approaches below.

Having regard to the summation valuation and our consideration of share transactions, we have formed a view on the most appropriate value to adopt for Xanadu's interest in the Khuiten JV prior to the Proposed Transaction for the purpose of this Report (refer to Section 8.7).

#### 8.1.2 Summation approach

We have applied the summation method, commonly used for entities where value is primarily derived from individual assets. Under this approach, each of the Khuiten JV's assets are valued separately on a market value basis, then aggregated to determine a total enterprise value. From this, liabilities and any other adjustments are deducted to derive an equity value.

Table 8.1 below summarises our summation valuation approach.

**Table 8.1: Summary of valuation methodologies utilised in our summation valuation**

Category	Description
Valuation of Xanadu's share of cash flows from the Khuiten JV	<p>To determine the fair value of Xanadu's interest in the Khuiten JV, we have applied a DCF valuation methodology, estimating the present value of Xanadu's share of future cash flows from the Khuiten JV. This includes:</p> <ul style="list-style-type: none"> <li>▶ Estimating the cash flows attributable to Xanadu, derived from its ownership in the Khuiten JV. We note this ultimately relies on the assumed cash flows from the Kharmagtai Project, which have been calculated based on the assumptions within the Financial Model, confirmed by ERM along with our own internal research;</li> <li>▶ Adopting an appropriate discount rate, reflecting the appropriate risk-adjusted return for the asset;</li> <li>▶ Adopting a reasonable valuation range, based on the DCF valuation outcomes; and</li> <li>▶ Conducting a sensitivity analysis, assessing how key variables (such as discount rates, commodity prices, and cost assumptions) impact the valuation.</li> </ul>
Mineral resource outside of the cash flows	We relied on ERM to provide a market value for the mineral resources outside of the cash flow model and added this value to the summation value of Xanadu's interest in the Khuiten JV.
Other assets / liabilities	We have valued Xanadu's proportion of the Khuiten JV's remaining assets and liabilities utilising a cost-based valuation methodology that makes reference to the book value of each individual item. We consider it standard industry practice to adopt the book value of items like cash and debt as their market value.

Source: BDOCF analysis

### 8.1.3 Share transactions approach

We have considered a valuation approach based on underlying share transactions for Xanadu to cross check the valuation of Xanadu's interest in the Khuiten JV. In relation to this approach we note:

- ▶ This approach is generally possible to complete when there is a readily observable market for the trading of the Company's shares. The shares of Xanadu are listed on the ASX and TSX and it is possible to observe the market price of trades in Xanadu shares prior to date of the Report. An approach based on share transactions generally provides information relating to a valuation of Xanadu shares on a minority interest basis; and
- ▶ We consider Xanadu's underlying share trading to be moderately liquid (as discussed in Section 5.3.2).

### 8.2 Overview of ERM's technical expert report ('ERM Report')

In completing our work, we have had regard to the ERM Report dated 11 March 2025 which, broadly, sets out:

- ▶ ERM's view on inputs adopted in the cash flow model provided by Xanadu;
- ▶ ERM's view of the appropriate market values of the Kharmagtai Project resources which are excluded from the Financial Model;
- ▶ ERM's view of the appropriate market values on the Red Mountain project; and
- ▶ ERM's view of the appropriate market values on the Sant Tolgoi project.

Mr Andrew Waltho of ERM supervised ERM's valuation of Xanadu's Kharmagtai, Red Mountain and Sant Tolgoi projects. Mr Andrew Waltho was assisted in completing the ERM Report by various ERM team members. Based on our enquiries and the information provided to us, we regard ERM and the authors of the ERM Report to be *Independent Specialists* as referred to in the code for the Technical Assessment and Valuation of Mineral and Petroleum Assets and Securities for Independent Specialist Reports ('the VALMIN Code').

Regarding the ERM Report we note the following:

- ▶ ERM has prepared the Report in accordance with
  - the VALMIN Code; and
  - the JORC Codes;
- ▶ ERM is independent with respect to Xanadu and confirms that there is no conflict of interest with any party involved in the Proposed Transaction and neither Xanadu nor any of its personnel involved in the preparation of the ERM Report have any material interest in Xanadu;
- ▶ Neither ERM nor the authors of the ERM Report have (or have had previously) any material interest in Xanadu or the properties in which Xanadu has an interest. No member or employee of ERM has (or has had) any material shareholding in Xanadu; and
- ▶ The statements and opinions contained in the ERM Report are given in good faith and in the belief that they are not false or misleading.

Based on our enquiries and the information provided to us, we regard ERM to be an independent specialist and in our view, it is appropriate for us to consider the work of ERM in completing this valuation work. ERM understand the purpose of the valuation work set out in this Report.

We confirm that we have been provided with express written consent by ERM to refer to and rely on the ERM Report for the purposes of our valuation work in this Report. We have made reasonable enquiries of ERM and are satisfied that the work and valuations in the ERM Report are suitable for use in this Report. Notwithstanding this, we do not take responsibility for the work of ERM.

Any references to ERM's work set out in this Report are in a summary form only and does not substitute for a complete reading of the ERM Report. Our summary does not include all the information that may be of interest to Non-Associated Shareholders. The ERM Report is attached to this Report as Appendix B. We recommend that Non-Associated Shareholders read the ERM Report in full and in conjunction to this Report and related statements.

### 8.3 Cashflow assumptions in relation to the Kharmagtai Project

Our cashflow assumptions in relation to the Kharmagtai Project are set out as follows:

- ▶ Section 8.3.1 sets out the basis of the Financial Model adopted for the DCF valuation;
- ▶ Section 8.3.2 sets out the revenue assumptions of the Financial Model;
- ▶ Section 8.3.3 sets out the expenditure assumptions of the Financial Model;
- ▶ Section 8.3.4 sets out the other cashflow assumptions within the Financial Model; and
- ▶ Section 8.3.5 sets out a summary of the cashflows in relation to the Kharmagtai Project.

### 8.3.1 Basis of the Financial Model adopted for the DCF valuation

We have been provided with three cash flow models from Management summarising the forecasted life-of-mine ('LOM') cashflows derived from the Kharmagtai Project:

- ▶ The Resources Model, which incorporates a production schedule from the estimated mineral resources;
- ▶ The Reserves Model, which incorporates a production schedule from the estimated ore reserves; and
- ▶ The Simplified Model, prepared by BACCHUS Capital Advisers, to simplify the calculations in the Resources Model.

We used the Simplified Model as the basis for our valuation purposes ('the Financial Model'). The Financial Model estimates the future cash flows expected from production and was prepared based on estimated production profiles, operating costs and capital expenditure. The Financial Model was prepared in real terms (rather than nominal) on a yearly basis. We have discounted all cash flows to mid-year 2025.

We have assessed the reasonableness of the Financial Model provided to us and the material assumptions that underpin it. We have made certain adjustments to the Financial Model where it was considered appropriate.

We undertook the following analysis on the Financial Model:

- ▶ Analysed the Financial Model to confirm its integrity and mathematical accuracy (to a material level);
- ▶ Appointed ERM as technical expert to review, and where required, provide changes to the technical assumptions underpinning the Financial Model;
- ▶ Conducted independent research on certain economic and other inputs such as commodity prices, exchange rates, and the discount rate applicable to the future cashflows; and
- ▶ Performed a sensitivity analysis on the value of the Kharmagtai Project by varying selected key assumptions and inputs in isolation.

We have not undertaken a review of the cashflow forecasts in accordance with the Standard on Assurance Engagements ASAE 3450 *Assurance Engagements involving Corporate Fundraisings and/or Prospective Financial Information* and do not express an opinion on the achievability of the forecast. However, nothing has come to our attention as a result of our procedures to suggest that the assumptions on which the Financial Model has been based have not been prepared on a reasonable basis.

Several of the assumptions adopted in the Financial Model are subjective and may be subject to material change in short periods of time. Changes in these assumptions may have a material impact on the overall value determined in this Report. There can be no guarantee that the cashflow forecasts or valuation calculations will remain reliable for any length of time as circumstances are continually changing.

### 8.3.2 Revenue assumptions of the Financial Model

#### *Production and development timing*

The Financial Model initially assumed a total ore mined of 1,262 million tons, including both indicated and inferred resources. In consulting with ERM, we consider it more appropriate to base production assumptions on ore reserves alone. Regarding this, we adopted the production assumptions from the Reserves Model, which assumes a total ore mined of approximately 732 million tons, and incorporated them into the Financial Model. The Financial Model forecasts to commence production in calendar year ('CY') 2028 with a processing rate up to 26.0 million tonnes per annum ('Mtpa') to process the sulphide ore during the first eight years. The production is expected to increase the processing rate to 52.0 Mtpa in CY36 and continue until completion in CY47. The Financial Model also includes processing of oxide ore at a rate of 0.5 Mtpa during the first eight years, with no further oxide production expected beyond CY35.

The total ore mined for each deposit is set out below:

- ▶ Stockwork Hill is forecasted to produce approximately 233 Mt between CY27 and CY47;
- ▶ White Hill is forecasted to produce approximately 447 Mt between CY28 and CY44;
- ▶ Copper Hill is forecasted to produce approximately 22 Mt between CY27 and CY45;
- ▶ Golden Eagle is forecasted to produce approximately 13 Mt between CY42 and CY44; and
- ▶ Zephyr is forecasted to produce approximately 16 Mt between CY38 and CY39.

In addition, a total of 4.0 Mt oxidised ore is forecasted between CY28 and CY35.

ERM have considered the proposed mining and processing schedule and not identified any material issues. In line with the mining schedule set out above, the forecast processing production per year is presented in Figure 8.1 below.

Figure 8.1: Forecast ore processed per year

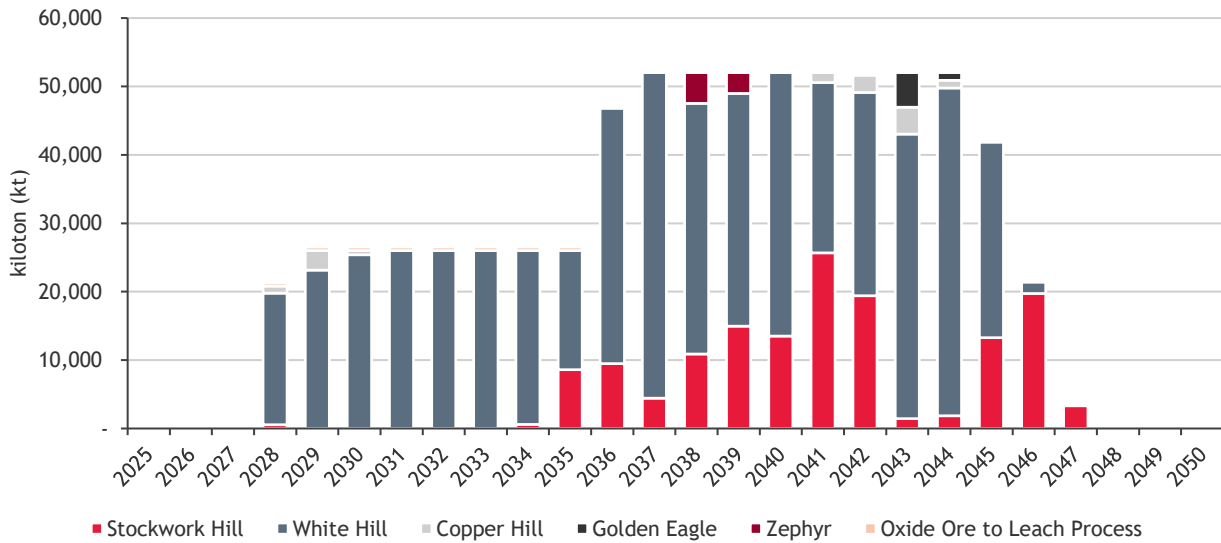

Source: The Financial Model, ERM report

Regarding Figure 8.1, we note that the ore grade varies within each deposit. In general, the proposed schedule processes higher-grade ore in the early years and lower-grade ore in later years. Management advised that the targeted recovery of high-grade ore early in the LOM is a common practice in mine planning to allow for a faster payback period. We note that, while ore processing doubles between 2035 and 2037, the average grade of the processed material declines substantially during the same period. This results in the net smelter return ('NSR'), set out in Figure 8.4 below, increasing only slightly relative to the years prior to 2036, as opposed to doubling.

Commodity prices

We adopted the average commodity price forecasts sourced from Consensus Economics for gold and copper on a real basis in the Financial Model. Consensus Economics provided nominal annual price forecasts from CY25 to CY29 and both nominal and real price forecasts for the long term (2030-2034). We derived the implied inflation rate from the long-term forecasts and used it to calculate the real annual price forecasts for CY25 to CY29. The long-term price forecasts were adopted for the rest of the LOM. A summary of the price forecast on a real basis is presented in the Table 8.2 below.

Table 8.2: Average commodity price forecasts

Commodity (real)	Spot	2025	2026	2027	2028	2029	2030+
Gold (US\$/oz)	2,708	2,675	2,577	2,415	2,298	2,232	2,230
Copper (US\$/lb)	4.5	4.6	4.7	4.8	4.8	4.9	4.2

Source: Consensus Economics as of January 2025

The high, average and low price forecasts as provided by Consensus Economics for gold and copper are presented in Figures 8.2 and 8.3 respectively.

Figure 8.2: Gold commodity price forecasts

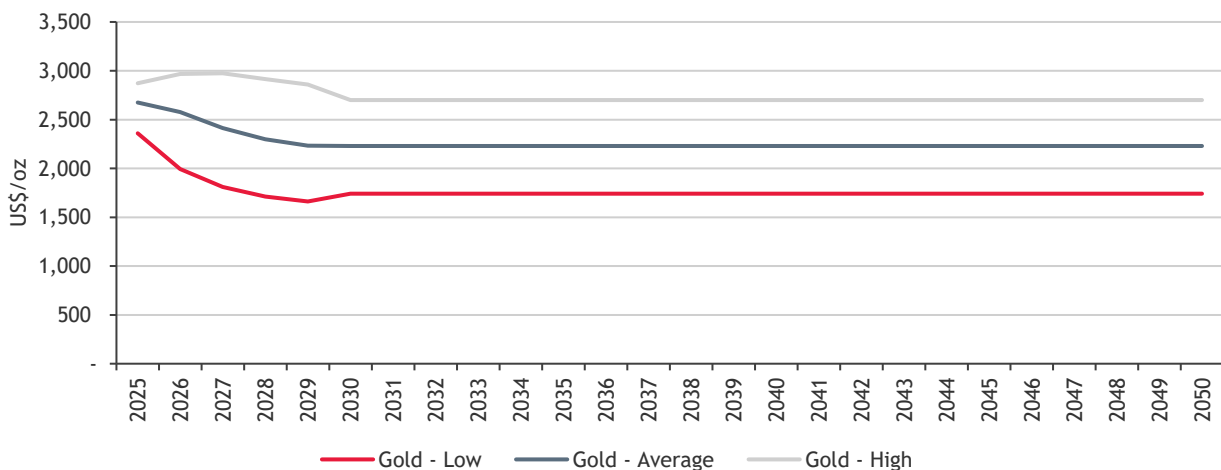

Source: Consensus Economics as of January 2025

Figure 8.3: Copper commodity price forecasts

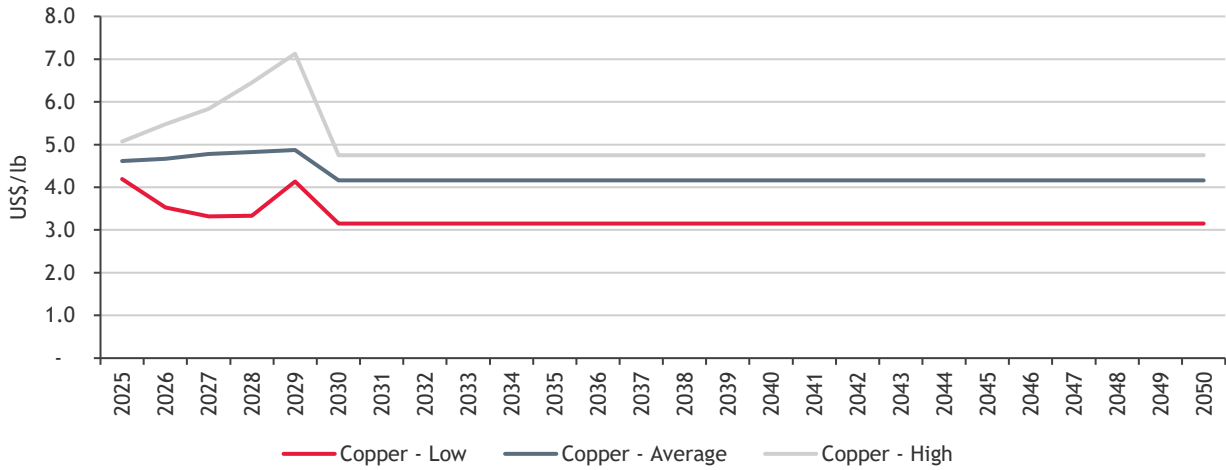

Source: Consensus Economics as of January 2025

Other assumptions related to revenue

The Financial Model uses NSR to calculate the revenue generated from the sale of the metals after accounting for:

- ▶ Smelting and refining costs;
- ▶ Shipping costs, and
- ▶ Marketing costs.

A summary of assumptions regarding the smelting and refining costs is presented in Table 8.3.

Table 8.3: Smelting and refining costs

Smelting and refining costs	Average
Copper concentrate smelting (US\$/ton)	72.02
Copper refining (US\$/lb)	0.07
Gold refining (US\$/oz)	4.5
Dore Gold refining (US\$/oz)	2.27

Source: The Financial Model

A summary of the NSR breakdown is presented in Figure 8.4 below. We note that although production volume is scheduled to increase significantly from 2036, the impact on revenue is offset by the decline in ore grade.

Figure 8.4: Net smelter return per year

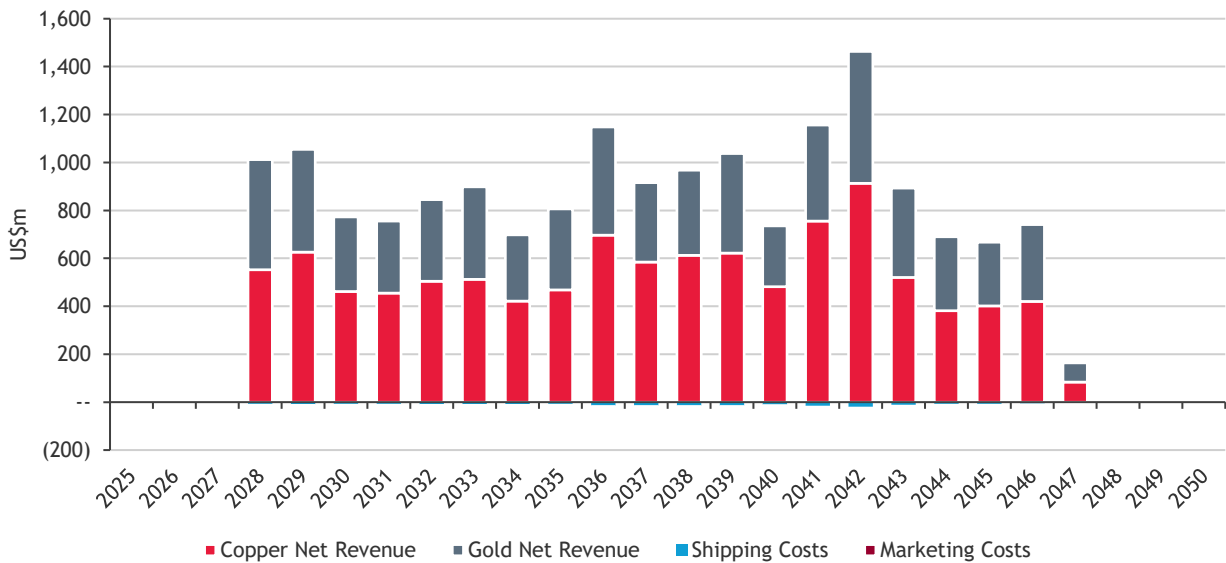

Source: The Financial Model

For personal use only

### 8.3.3 Expenditure assumptions of the Financial Model

#### CAPEX

The CAPEX breakdown is set out below in Table 8.4 on a real term basis.

**Table 8.4: CAPEX breakdown**

Category	US\$m
Sulphide plant	636
Infrastructure	163
Overheads	12
Carbon in leach	73
<b>Initial CAPEX</b>	<b>884</b>
Sulphide plant	541
Infrastructure	162
Overheads	1
<b>Expansion CAPEX</b>	<b>704</b>
<b>Total development CAPEX</b>	<b>1,589</b>
Sustaining Capital Expenditure	277
<b>Total Capital Expenditure</b>	<b>1,866</b>

Source: The Financial Model

The Financial Model assumes an initial development CAPEX of US\$884 million from CY25 to CY28 to develop initial mining activities and the 26.0 Mtpa processing plant. This is followed by a further US\$704 million from CY33 to CY39 to expand processing capacity to 52.0 Mtpa. Sustaining CAPEX remains stable throughout the LOM, with relatively high CAPEX near the end of the mine driven by the closure costs.

ERM have critically analysed the CAPEX assumptions for the Kharmagtai Project. ERM consider the cost estimates for the project are significantly lower than those of comparable projects in the region. To address their concern, ERM held discussions with the technical experts who prepared the PFS and found that the approaches adopted in the preparation of the PFS represented sound industry practice. For further details, please refer to the ERM Report in full attached in Appendix B.

The CAPEX over the LOM is presented in Figure 8.5 below.

**Figure 8.5: Annual CAPEX breakdown**

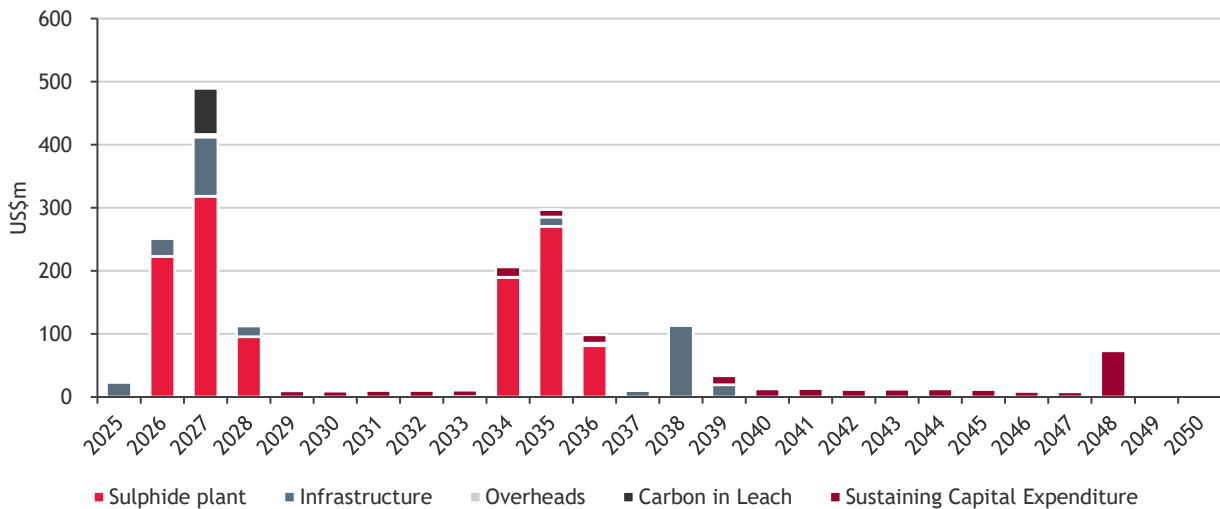

Source: The Financial Model

#### Operating expenditure ('OPEX')

OPEX includes mining, processing, general and administration, corporate overheads, and royalties.

OPEX over the LOM is presented in Figure 8.6 below. For completeness we note that that we have further discussed royalties in Section 8.3.4.

ERM consider that the mining expenses are low but have been rigorously estimated and are supported by ERM while the remaining expenses are considered reasonable.

For personal use only

Figure 8.6: Annual OPEX breakdown

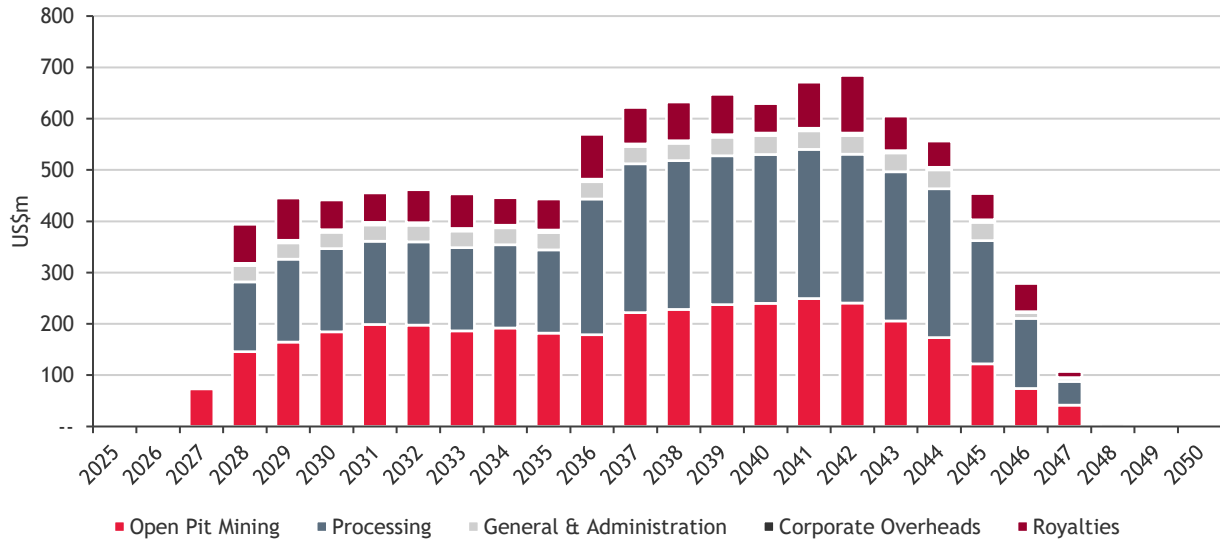

Source: The Financial Model

### 8.3.4 Other cashflow assumptions within the Financial Model

#### Working capital

The Financial Model includes working capital assumptions for:

- ▶ Accounts Payable: the accounts payable closing balance is derived from accruing eight weeks of the trailing annual OPEX; and
- ▶ Accounts Receivable: the accounts receivable closing balance is derived from accruing four weeks of the trailing annual NSR.

We note that, based on our experience valuing projects similar to the Kharmagtai Project, we do not believe any of the above assumptions are unreasonable.

We removed the inventory level assumptions of processed concentrate as the Financial Model assumes that the concentrate is produced and sold in the same period.

#### Royalties

In Mongolia, mining companies are required to pay royalties based on the sales value of the minerals and the royalty rate is referenced to the commodity price. According to the current legislation, the price forecast assumptions adopted in the Financial Model would result in a royalty rate of 20% for copper and a royalty rate of 5% for gold.

We note that the PFS considered a draft royalty legislation published in 2023 which implies a copper rate of around 8.34% based on the price forecast in the PFS, as opposed to the current 20% royalty.

ERM considers royalty rates for copper to be low. However, ERM accepts that, based on the precedents set by other similar projects in Mongolia, companies have the ability to negotiate royalty rates with the Mongolian government in establishing investment agreements for major projects. On this basis, ERM supports the use of the 8.34% royalty rate in the Financial Model.

We adopted the royalty rates as referenced to the draft legislation in the Financial Model and also set up a sensitivity analysis to test the impact of the royalty on our valuation. The sensitivity analysis is discussed in more detail in Section 8.5.3.

For completeness, we note that there are no formal agreements between OU (the holding entity of the Kharmagtai Project) and the local government. The royalty rates will ultimately be negotiated along with other key taxes and commercial topics as part of an investment agreement in the next phase of the Kharmagtai Project's development.

Management of Xanadu confirmed that there is no private royalty agreement in place for OU.

For personal use only

### Depreciation

Depreciation is allowed for in the Financial Model as a deduction in the income tax calculation. The Financial Model uses the straight-line method for depreciation which means that some fixed assets have remaining useful life at the end of the mine's life. The useful life assumptions are:

- ▶ 40 years for buildings, facilities and landscape;
- ▶ 10 years for vehicles, machineries, mechanisms, production equipment;
- ▶ 2 years for computers, accessories and software;
- ▶ 20 years for intangible assets, including minerals exploration and mining licenses; and
- ▶ 10 years for other assets.

### Tax

The Financial Model incorporates assumptions for company income tax, value added tax ('VAT') and import duties. The income tax calculation assumes a 10% tax rate for the first six billion Mongolian Tugriks of taxable income and a tax rate of 25% for the taxable income above six billion Mongolian Tugriks. The income tax was calculated on a nominal basis and then converted to a real basis. To convert the income tax to nominal figures, we adopted an assumed 2% inflation rate as referenced to the US Federal Reserve's long-term target<sup>31</sup>. Tax losses were also assumed to be carried forward to offset future profits.

The Financial Model assumed a 10% VAT and a 5% customs duty. We note that the customs duty is assumed to be applicable to 34% of project CAPEX, 3.2% of sustaining CAPEX and 44.6% of OPEX.

#### 8.3.5 Summary of the assumed cash flows for the Kharmagtai Project

The annual cashflow and the cumulative cashflow over the LOM are presented in Figure 8.7.

Figure 8.7: Kharmagtai Project annual cashflows

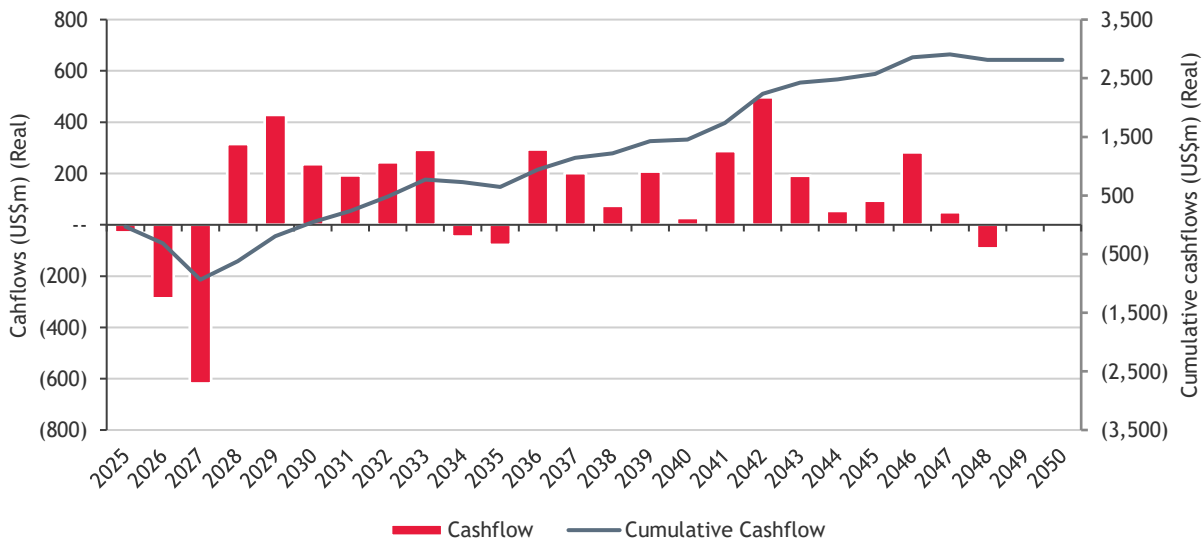

Source: The Financial Model

#### 8.4 Conversion of Kharmagtai Project cash flows to Xanadu's cashflows

To complete a DCF valuation of Xanadu's cash flows, we must first convert the 100% Kharmagtai Project cashflows into the cashflows attributable to Xanadu's interest in the Khuiten JV. We have set out these adjustments below separately for the construction phase and operating phase, with a corresponding diagram to illustrate the process.

##### 8.4.1 Construction Phase Adjustments

During the construction phase, specific adjustments are required to account for CAPEX funding and the Khuiten JV's ownership structure. The key adjustments include:

- ▶ Calculating the funding requirement for MML, as it provides 100% of the CAPEX funding (noting QGX's 10% interest has no funding risk). The starting point aligns with the cashflows summarised in Section 8.3 for the Kharmagtai Project;

<sup>31</sup> US Federal Reserve: [https://www.federalreserve.gov/faqs/economy\\_14400.htm](https://www.federalreserve.gov/faqs/economy_14400.htm)



- ▶ Assuming a loan between MML and QGX. MML will contribute cash on QGX's behalf, and the loan will be repaid once the Kharmagtai Project starts operating. An interest rate of 1% + Prime Rate, compounding quarterly, is assumed on the loan<sup>32</sup>; and
- ▶ Calculating the funding requirement for the Khuiten JV, as it contributes 85% of MML's funding. We assumed the Decision to Mine is reached before the construction time<sup>33</sup>. Accordingly, Ganbayar's must fund its respective share of the development project.
- ▶ Calculating Xanadu's funding requirement which is equal to 50% of Khuiten JV's funding requirement.

#### 8.4.2 Operating Phase Adjustments

As the Kharmagtai Project transitions into operations, the adjustments made during the construction phase begin to reverse. Cash flows attributable to the Khuiten JV are now impacted by the ownership structure, the repayment of any funding arrangements from the construction phase, and the distribution of operating cash flows between the JV partners. The key adjustments include:

- ▶ Allocating the cash flows summarised in Section 8.3 for the Kharmagtai Project between MML and QGX. Once the Kharmagtai Project begins production, MML will receive 90% of the distribution, and QGX will receive 10%. Within QGX's 10% share, 90% will be used to repay the loan to MML until it is fully repaid;
- ▶ Applying tax adjustments to cash distributions from MML. The Khuiten JV receives 85% of the distribution from MML. However, a 5% withholding tax is assumed to be applicable to the dividends paid to Khuiten JV, as Mongolia imposes this tax on distributions to Singaporean companies with at least a 25% ownership stake, which applies in this case as the Khuiten JV has an 85% interest in MML; and
- ▶ Calculating cash distributions to Xanadu. Xanadu will receive 50% of the distributions from the Khuiten JV. When dividends are distributed from the Khuiten JV (a Singaporean company) to Xanadu, the dividend will be considered as non-assessable non-exempt income and no income tax is payable on receipt of the dividend.

#### 8.4.3 Diagram of the adjustments

Figure 8.8 below illustrates the key steps in converting the 100% Kharmagtai Project cash flows into the cash flows attributable to the Khuiten JV across both phases.

Figure 8.8: Cash flows prior to the Proposed Transaction

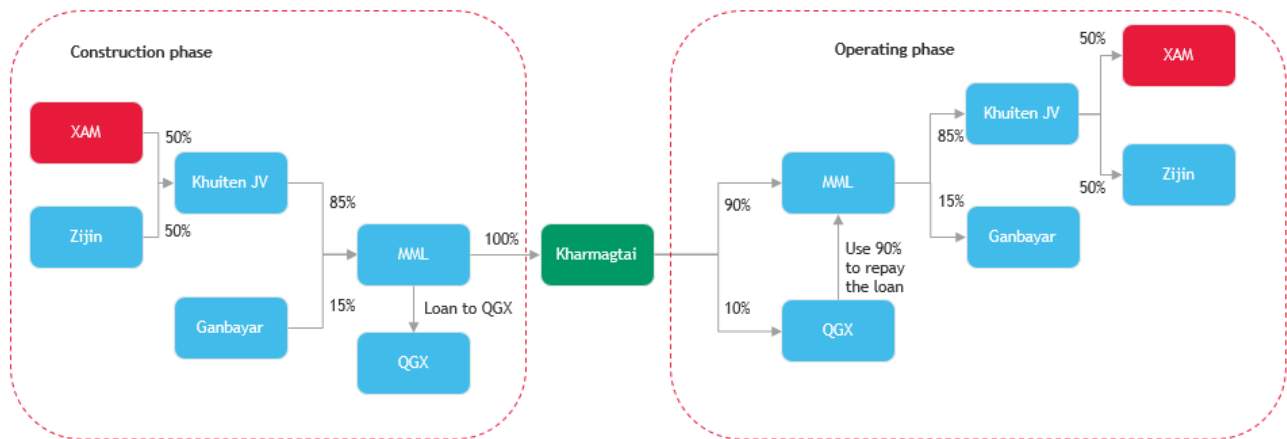

Source: BDOCF analysis

#### 8.4.4 Summary of the Xanadu's share of the annual cashflows from the Kharmagtai Project

Xanadu's share of the annual cash flows and the cumulative cash flows on a real term basis over the LOM for Khuiten JV are set out below in Figure 8.9.

<sup>32</sup> The project agreement states that the loan to QGX accrues and compounds quarterly at the Prime Rate +1% per annum.

<sup>33</sup> Management advised that the Decision to Mine will be reached in the Financial Investment Decision ('FID') phase which is before the construction phase. There might be a small portion of CAPEX in the Financial Model over which Ganbayar is not exposed to funding risk, but the impact on the cashflow is not material based on Management's instructions.

Figure 8.9: Cash flows over the LOM for Xanadu

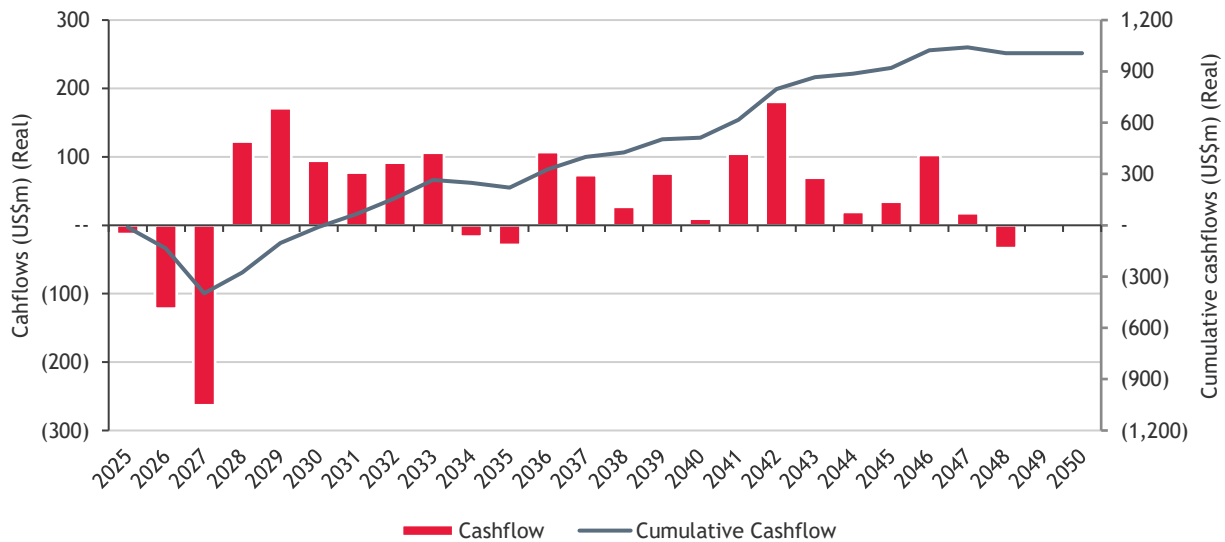

Source: BDOCF analysis

### 8.5 Value of the Khuiten JV cash flows to Xanadu

To determine the value of Xanadu’s interest in Khuiten JV, we have applied a DCF valuation methodology. In doing so, we estimated the present value of Xanadu’s share of future cash flows related to the JV. This section outlines:

- ▶ The discount rate applied, reflecting the appropriate risk-adjusted return for the cash flow attributable to Xanadu, derived from its ownership in the Khuiten JV;
- ▶ The value adopted, based on applying our adopted discount rate to the cash flows attributable to Xanadu; and
- ▶ A sensitivity analysis, assessing how key variables (such as discount rates, commodity prices, and cost assumptions) impact the valuation.

#### 8.5.1 Discount rate adopted

The discount rate represents the rate of return that capital providers expect from their capital contribution and is typically based on the weighted average cost of capital (‘WACC’) for the asset being valued. In broad terms, the WACC considers the rate of return required by capital providers given the riskiness of the future cash flows and the cost of financing using debt instruments for the relevant asset. We have selected a real discount rate of 13.0% to 16.0% to discount the free cash flows of the Khuiten JV which are attributable to Xanadu, to calculate a present value. In selecting a discount rate, we have considered the following:

- ▶ The required rate of return of comparable companies in the mining sector, with copper and gold exposure;
- ▶ The capital structure of comparable mining companies;
- ▶ The cost of equity derived from applying the capital asset pricing model (‘CAPM’) methodology (a commonly used methodology for deriving the cost of equity). In relation to CAPM, we note the cost of equity capital is determined by multiplying the market risk premium by an appropriate beta and adding the risk-free rate. Our view on the appropriate inputs to the CAPM to apply in the circumstances are as follows:
  - a risk-free rate of 4.58% based on the US Treasury 10-year spot rate, as at 31 January 2025;
  - an unlevered beta in the range of 0.9 to 1.1. To determine an appropriate beta, we have considered the equity and asset betas of broadly comparable companies;
  - an equity market risk premium of 6.0%. To assess an appropriate market risk premium, we have considered equity risk premiums of companies that operate in developed markets. We have had regard to numerous empirical studies that indicate that market risk premiums can be estimated within the range of 4.5% to 7.0% and that the average tends to vary between countries. For the purposes of this Report we considered it appropriate to adopt a market risk premium of 6.0%;
  - a country risk premium of 4% - 5% for Mongolia. We note that Professor Damodaran at New York University’s Stern School of Business published a country risk premium of 7.34% in January 2025. However, we consider that the ability to sell the Kharmagtai Project’s commodities to global markets could mitigate the country risk premium by diversifying revenue exposure and reducing reliance on the Mongolian’s domestic economy.

- ▶ The CAPM framework assumes that investors are well-diversified and, therefore, primarily concerned with systematic risk rather than the specific risks of individual investments. However, in our view, certain risks unique to a project, and particularly those that are difficult to quantify or incorporate into base case cash flows, may lead investors to apply a company-specific risk premium. In this case, we believe the risk factors identified by ERM (e.g. CAPEX, OPEX and royalty negotiations) justify the inclusion of such a premium in the discount rate to appropriately reflect these additional risks.
- ▶ The cost of debt capital which is the expected future borrowing cost. We have assumed a required return on debt having regard to:
  - the comparable companies’ borrowings rates;
  - 10-year BBB rated corporate bonds;
  - 30-year BBB rated corporate bonds; and
  - country credit default rate of 5.45%.
- ▶ The highest Mongolian corporate tax rate of 25%; and
- ▶ A long-term inflation rate of 2% as referenced to the target set by the US central bank to convert nominal discount rate to a real term basis.

Taking the above factors into consideration as well as the nature of the Kharmagtai Project and its exposure to macroeconomic factors, we believe it is appropriate for the purposes of the analysis set out in this Report to adopt a real discount rate in a range of 13.0% to 16.0%.

We have set out a sensitivity analysis on the discount rate in Section 8.5.3 to assist users of this Report that may have an alternative view on an appropriate discount rate or who would like to understand the impact of applying an alternative discount rate.

### 8.5.2 DCF valuation

BDO CF has determined a value for Xanadu’s cashflows in the Khuiten JV using a DCF valuation methodology, as represented in the Financial Model across the LOM, using the assumptions stated in the preceding sections.

Table 8.5 below sets out a summary of our valuation of the cashflows. For clarity, the only difference between the low and high scenario is the discount rate applied. The low scenario uses the upper end of our discount rate range while the higher scenario uses the lower end of our discount rate range.

**Table 8.5: Xanadu’s value attributable to the Khuiten JV’s cash flows**

Khuiten cashflow value to Xanadu (US\$’m)	Low	High
DCF Value adopted for the mine	70	130

Source: BDOCF analysis

### 8.5.3 Sensitivity analysis of the DCF valuation

We have conducted a sensitivity analysis under different discount rates for the valuation of Xanadu’s share of the cash flows from the Khuiten JV. This is presented in Table 8.6. We have flexed several variables to test the sensitivity. The following variables have been adjusted in isolation, holding all other variables consistent:

- ▶ A ±10% increase in gold prices;
- ▶ A ±10% increase in copper prices;
- ▶ A ±10% increase in OPEX;
- ▶ A ±10% increase in CAPEX; and
- ▶ A ±5 percentage points change in copper royalty;

Users of this Report should note that:

- ▶ The variables described above may have compounding or offsetting effects and are unlikely to move in isolation;
- ▶ The variables for which we have performed sensitivities are not the only variables that are subject to deviation from the forecast assumptions; and
- ▶ The sensitivities we have performed do not cover the full range of possible variances from the base case assumptions assumed (i.e. variances could be greater than the percentage increase or decreases set out in this analysis).

The sensitivity analysis of the value of the cash flows associated with Xandu’s interest in the Khuiten JV is summarised below in Table 8.6.

**Table 8.6: Scenario analysis of the valuation of cashflows associated with Xanadu’s interest in the Khuiten JV**

Xanadu NPV prior to Transaction (US'm)	16.0%	13.0%
Base Case	68	130
Scaling by a percentage		
Gold Pricing (+10%)	125	203
Gold Pricing (-10%)	11	58
Copper Pricing (+10%)	107	179
Copper Pricing (-10%)	29	82
OPEX (+10%)	16	64
OPEX (-10%)	120	197
CAPEX (+10%)	61	122
CAPEX (-10%)	76	138
Change by percentage points		
Copper Royalty (+5%)	38	91
Copper Royalty (-5%)	99	169

Source: BDOCF analysis

## 8.6 Value of Xanadu’s Interest in the Khuiten JV

To determine the value of Xanadu’s interest in the Khuiten JV, we have:

- ▶ Derived the net present value (‘NPV’) of Xanadu’s attributable cash flows from the Khuiten JV, based on the Financial Model and projected LOM assumptions (refer Section 8.5 above);
- ▶ Considered additional value for Xanadu’s proportionate interest in mineral resources that are outside the current LOM plan, reflecting potential future economic upside;
- ▶ Adjusted for Xanadu’s proportionate share of other assets and liabilities within the Khuiten JV that are not explicitly captured in the DCF model; and
- ▶ Considered practical constraints that may impact the realisable value of Xanadu’s 50% interest in the Khuiten JV including discounts for the non-controlling nature of the interest, liquidity and marketability constraints, and funding and dilution risks.

### 8.6.1 The Kharmagtai Project’s resources value outside of the Financial Model

We have relied on the ERM Report to value the Kharmagtai Project’s resources value that is not incorporated in the Financial Model. We have then attributed that value to Xanadu based on the ownership structure of the Kharmagtai Project. Based on ERM’s assessed value, the value attributed to Xanadu is between US\$21.0 million to US\$36.0 million.

Non-Associated Shareholders should refer to the ERM Report in Appendix B for further information on the values ERM have calculated.

### 8.6.2 Value of Khuitens’s other assets and liabilities

As at 31 December 2024 (the latest financial information available to us), the Khuiten JV has AU\$0.6 million (US\$0.4 million<sup>34</sup>) cash on hand. We have considered this and made relevant adjustments when valuing Xanadu’s interest in the Khuiten JV.

We have also considered the ongoing cost of the Khuiten JV’s corporate overheads. Xanadu management advised that the Khuiten JV will serve as a holding company and the expenses charged to the Khuiten JV will be passed on to OU, the holding company of the Kharmagtai Project. Regarding this, we consider the corporate overheads incurred by the Khuiten JV to be immaterial to the analysis set out in this Report.

### 8.6.3 Value of Xanadu’s Interest in the Khuiten JV before adjustments for marketability and control

Table 8.7 sets out our valuation of Xanadu’s interest in Khuiten JV before adjustments for marketability and control.

<sup>34</sup> All conversions from AUD to USD use the average AUD:USD exchange rate in January 2025 from the Reserve Bank of Australia.

**Table 8.7: Xanadu’s interest in the Khuiten JV before adjustments for marketability and control**

US\$m	Reference	Low	High
Xanadu’s Khuiten JV DCF value	Section 8.5.2	70.0	130.0
Other resources not incorporated in the DCF model	Section 8.6.1	10.1	36.0
<b>Enterprise Value</b>		<b>90.0</b>	<b>166.0</b>
<b>Add/(less) surplus assets/(liabilities)</b>			
Cash @ 50%	Section 8.6.2	0.2	0.2
<b>Khuiten Equity Value</b>		<b>91.2</b>	<b>166.2</b>

Source: BDOCF analysis

**8.6.4 Adjustments to Xanadu’s pro rata valuation of Khuiten JV for marketability and control**

In valuing Xanadu’s 50% interest in the Khuiten JV, we have derived a DCF-based valuation of the future cashflows attributable to Xanadu along with Xanadu’s proportionate share of other assets and liabilities. However, given that this valuation represents a pro-rata share of the Khuiten JV’s value, adjustments are required to be considered to reflect constraints on liquidity, marketability, and funding risks. We have discussed these further in Table 8.8 below.

**Table 8.8: Qualitative considerations in relation to the control, marketability and liquidity of Xanadu’s interest in the Khuiten JV**

Category	Description
Non-controlling nature of the interest	<p>The Khuiten JV has an interest in the Kharmagtai Project of approximately 76.5%. Xanadu has an interest of 50% in the Khuiten JV and, therefore, an indirect interest in the Kharmagtai Project of 38.25%.</p> <p>Xanadu’s 50% stake in the Khuiten JV does not confer control over the underlying Kharmagtai Project. The JV Agreements specifies that since the expiry of the PFS Delivery Period:</p> <ul style="list-style-type: none"> <li>▶ Zijin has the right to appoint the Khuiten JV’s Board of Directors Chairperson;</li> <li>▶ Zijin is the operator of the Khuiten JV;</li> <li>▶ Zijin has the right to appoint the Khuiten JV’s General Manager; and</li> <li>▶ The General Manager has significant influence over the direction of the Khuiten JV via his/her ability to prepare development plans and budgets, hire key personnel, enter into and manage key contracts, etc.</li> </ul> <p>Xanadu does retain significant influence in the Khuiten JV through:</p> <ul style="list-style-type: none"> <li>▶ The appointment of two Directors giving Xanadu and Zijin equal voting rights on the Khuiten JV’s Board of Directors;</li> <li>▶ Xanadu has the right to appoint the Deputy General Manager whose duties confer significant influence in the development and planning of the Kharmagtai Project. For completeness, we understand that the Deputy General Manager is subordinate to the General Manager; and</li> <li>▶ Xanadu can effectively block the Khuiten JV’s costs to be financed through loans advanced by shareholders because this decision requires a unanimous vote by the Board of Directors.</li> </ul> <p>On balance, given the facts listed above, our view is that Xanadu is limited in its ability to:</p> <ul style="list-style-type: none"> <li>▶ Influence project development plans, budgets and timelines and capital allocation; and</li> <li>▶ Control potential exit pathways, as Zijin remains the dominant strategic partner and Zijin (like Xanadu) has a first right of refusal that somewhat limits Xanadu’s ability to dispose of its shares in the Khuiten JV.</li> </ul> <p>In our view, the lack of control over cash flow realisation and project execution necessitates a minority interest discount albeit one that reflects Xanadu’s significant influence over key decisions.</p>
Illiquidity and marketability constraints	<p>Unlike a 100% direct ownership interest in the Kharmagtai Project, Xanadu’s stake in the Khuiten JV represents a private, non-traded equity interest, which is more difficult to monetise. Key liquidity constraints include:</p> <ul style="list-style-type: none"> <li>▶ Absence of an active secondary market for mining JV stakes;</li> <li>▶ Dependence on Zijin as a potential buyer, given both parties’ rights of first refusal, tag along and drag along rights which may limit any competitive sale process; and</li> <li>▶ Restrictions within the JV agreement that may influence transferability of shares including specific clauses pertaining to a shareholder’s ability to transfer shares to a related corporation and the requirement of a unanimous vote of shareholders on transfer of shares to another entity.</li> </ul>

For personal use only

Category	Description
Funding and dilution risk - Xanadu level	<p>Xanadu does not currently hold sufficient cash reserves to fund its share of future Kharmagtai Project development costs. As the Kharmagtai Project advances towards feasibility, construction and commercialisation, significant capital will be required. Specifically, the total CAPEX requirements for the Kharmagtai Project is expected to be approximately US\$1.6 billion, excluding any sustaining CAPEX requirements or any up-front net working capital requirements.</p> <p>Assuming that 100% of this US\$1.6 billion will be funded by the Khuiten JV, of which Xanadu owns a 50% interest, Xanadu's proportional share of this CAPEX is approximately US\$0.8 billion which is significantly greater than Xanadu's current market capitalisation of approximately A\$97.5 million as at 26 February 2025 (based on data extracted from CapIQ).</p> <p>To raise this quantum of capital, we consider it likely that Xanadu would be required to complete a material capital raising(s). Any capital raising(s) completed by Xanadu would likely be at a material discount to the prevailing share price.</p> <p>By way of example, for Xanadu's most recent capital raising completed on 8 January 2025, Xanadu announced to the ASX the placement of 26,515,543 fully paid ordinary shares to Jinping (Singapore) Mining Pte Ltd, a wholly owned indirect subsidiary of Zijin, at an issue price of A\$0.055 per share. Details of this placement had previously been communicated to the ASX on the 5<sup>th</sup> and 14<sup>th</sup> November 2024.</p> <p>The placement's issue price of A\$0.055 per share was lower than the closing share price of A\$0.0647 recorded on 31 October 2024, being the last recorded trading share price before Xanadu announced a trading halt on 1 November 2024. In comparison to this share price, the placement issue price represented a discount of approximately 15%. For completeness, we note that when Xanadu shares resumed trading on 5 November 2024, the share price converged towards the placement's share price, closing at A\$0.0562. From our experience and research, for capital raisings of the order that may be required by Xanadu to fund its share of the Kharmagtai Project, discounts to share price can be 50% or higher.</p> <p>Large capital raisings introduce dilution risk because the post-raising valuation tends to converge towards the price at which the new shares were issued. If the capital raising is completed at a discount to the DCF-derived valuation per share, the overall value of the company on a per-share basis will be lower than if the valuation were based solely on the DCF approach.</p> <p>In our view, it is appropriate to allow a discount for the dilution risk associated with Xanadu's funding requirements for the Khuiten JV, noting that our DCF valuation assumes that an owner of the asset has access to sufficient funding. This is on the basis that our assessment considers the value to Xanadu of selling half of its interest in the Khuiten JV, as opposed to a control transaction of the asset where the marginal acquirer may not have the same issues as Xanadu with securing funding to progress the Kharmagtai Project (e.g. a much larger entity).</p>
Funding and dilution risk - Khuiten JV level	<p>If Xanadu cannot meet its funding obligations, the main recourse mechanism in the Khuiten JV agreement is a share dilution mechanism which allows a joint venture partner (in this case Zijin) to fund the other party's funding shortfall in exchange for additional equity directly in the Khuiten JV. This mechanism is summarised in Section 5.1.1 of this Report.</p> <p>Based on the dilution formula described in Section 5.1.1 of this Report, we have performed various scenario analysis to simulate the potential dilution of Xanadu in the Khuiten JV if the Company is unable to meet Xanadu's share of the Kharmagtai Project's development CAPEX.</p> <p>From our analysis, if Xanadu is unable to fund its share of the capital development costs, Xanadu would be left with an ownership interest in the Khuiten JV of 25% which is half of the Company's current interest in the Khuiten JV.</p>

Source: BDOCF analysis

Having regard to Table 8.8 above, we consider that a discount in the range of 30% to 40% would be appropriate. For the purposes of the analysis set out in this Report, we have adopted the midpoint of 35% to apply as the discount to Xanadu's pro rata valuation of the Khuiten JV, of which we consider 15% relates to marketability and lack of control, and 20% relates to funding and dilution risk.

### 8.6.5 Valuation of Xanadu's interest in the Khuiten JV

Table 8.9 sets out our valuation of Xanadu's interest in the Khuiten JV.

**Table 8.9: Xanadu's interest in Khuiten JV**

	Reference	Low	High
Khuiten Equity Value (\$USm)	Section 8.6.3	91.2	166.2
Marketability and (lack of) control discount	Section 8.6.4	15%	15%
Funding and dilution risk discount	Section 8.6.4	20%	20%
<b>Khuiten Equity Value (\$US'm)</b>		<b>59.3</b>	<b>108.0</b>
AUD:USD Exchange Rate		0.62	0.62
<b>Khuiten Equity Value (AU\$m)</b>		<b>95.2</b>	<b>173.5</b>

Source: BDOCF analysis

## 8.7 Consideration of the share transaction valuation methodology

To assess the market's implied valuation of Xanadu's interest in the Khuiten JV, as compared to our summation valuation, we have considered Xanadu's market capitalisation and the assets that contribute to this value. This involves:

- ▶ Estimating the implied value of Khuiten JV as at the time of the announcement of Zijin's strategic partnership;
- ▶ Estimating Xanadu's market capitalisation based on the Company's trading price and outstanding shares;
- ▶ Identifying the assets that the market assigns value to, including the Khuiten JV and other material holdings;
- ▶ Isolating the implied market valuation of the Khuiten JV by subtracting the estimated value of the non-Khuiten JV assets and liabilities; and
- ▶ Comparing this implied market value to our summation valuation.

### 8.7.1 Estimating the implied value of the Khuiten JV as at the time of the announcement of the strategic partnership

On 19 April 2022, Xanadu announced that the Company had entered into a strategic partnership with Zijin. The partnership involved phased investment by Zijin into both the equity of Xanadu and the equity of the Khuiten JV.

Across all three phases, Zijin contributed the following:

- ▶ AU\$12.76 million for a 19.95% ownership in Xanadu shares;
- ▶ US\$35 million for a 50% joint venture interest in the Khuiten JV; and
- ▶ Various other agreements including the options agreement which is the subject of this Report.

Based on the above information, we can derive an implied estimate as to the total value of the Khuiten JV as at the date of the agreement, being 19 April 2022.

For clarity, in implying our value of the Khuiten JV as 19 April 2022, we have considered only the US\$35 million cash in isolation of Zijin's other contributions. Our implied value of the Khuiten JV as at 19 April 2022 is set out in Table 8.10 below.

**Table 8.10: Implied value of Khuiten JV as at 19 April 2022**

Khuiten JV value (US\$m)	Value
Zijin cash contribution (A)	35
Zijin ownership of JV (B)	50%
Implied value of the Khuiten JV (post money) (A/B)	70
AUD/USD FX rate as at 19 April 2022	0.74
<b>Implied value of Khuiten JV (post money AU\$m)</b>	<b>95.0</b>

Source: ASX Announcements, BDO Analysis

Regarding the above, we note that the implied valuation of the Khuiten JV, on a post money and controlling interest basis, was approximately AU\$95.0 million as at 19 April 2022.

Considering this, we note that the implied valuation of the Khuiten JV as at 19 April 2022 broadly aligns with the bottom end of our calculated value of the equity of Khuiten JV set out in the preceding sections. We believe this is reasonable as, the implementation of the strategic agreement happened approximately three years prior to the date of this Report, and many value influencing factors have materially changed since.

### 8.7.2 Estimating Xanadu's market capitalisation

Xanadu's ordinary shares are listed on the ASX and TSX under the ticker 'XAM'. Information relating to recent share trading data and an analysis of recent ASX announcements is provided in Section 5.3. As outlined in Section 5.3.1, Xanadu shares exhibit a moderate level of liquidity which is appropriate for considering a share transaction valuation methodology.

Given that Xanadu released the PFS in October 2024, we consider the 1-month and 3-month VWAPs displayed in Table 5.7 to be the most relevant for our analysis, as they reflect trading activity following the release of the PFS. The 12-month VWAP is considered less relevant due to the potential impact of outdated market conditions however is presented for completeness.

Whilst there will be entities listed on either the ASX and/or the TSX which demonstrate a higher degree of liquidity than Xanadu, we are of the view that the trading price in Xanadu shares on the ASX present relevant and useful information in relation to the market's view of a minority holding in Xanadu. For example, we note the increase in share price on and around 14 October 2024, when the Company announced the results of the PFS. In our view, this represents evidence of the market incorporating new information into the pricing of Xanadu shares.

Nothing in the data from the trading prices of Xanadu indicates that trading prices have been materially and persistently impacted by illiquidity relative to the supply and demand through the period shown in Table 5.7 above. In no period, through the historical period we have analysed for our transaction valuation cross-check, has there been significant gaps without trading activity.

In our view:

- ▶ There is consistent trading in the Company's securities;
- ▶ We have no information to suggest that specific trades have unduly de-coupled the trading data relative to the value of a minority parcel of shares in Xanadu; and
- ▶ While there is a degree of volatility in the trading prices of Xanadu shares, this volatility is not outside the relativities of our range.

A summary of the share price analysis, including VWAPs and adjusted prices on a controlling basis, is presented in Table 8.11 below. We have included control premiums in Table 8.10 below for the reasons set out in Section 8.7.5.

**Table 8.11: Share price analysis - periods up to 31 January 2025**

AU\$	1 month	3 month	12 month
Lowest daily VWAP in period	0.0456	0.0456	0.0389
Highest daily VWAP in period	0.0491	0.0564	0.0787
Period VWAP	0.0472	0.0498	0.0571
Period VWAP with 20% control premium	0.0566	0.0598	0.0685
Volume of shares traded in period/shares outstanding	1%	7%	26%

Source: BDOCF analysis

In Table 8.12 below we have set out the implied market capitalisation for Xanadu based on 1.9 billion shares on issue. We note:

- ▶ As set out in Section 5.2.2 above, Xanadu has approximately 150.7 million unlisted equity instruments on issue. Allocating some value to these instruments would result in an enterprise value for Xanadu greater than the market capitalisation shown below. However, as these instruments have performance conditions to meet, incorporating their value is not as simple as multiplying the share price by the number of instruments;
- ▶ Xanadu has AU\$6.2 million in cash as at 31 December 2024<sup>35</sup>. To calculate an enterprise value for Xanadu the cash should be subtracted; and
- ▶ We have not adjusted for either of the above items (and they would offset to some degree), however note that this will not materially alter the conclusions set out in this Report.

A summary of market capitalisation analysis, including VWAPs and adjusted prices on a controlling basis, is presented in Table 8.12 below.

**Table 8.12: Market capitalisation analysis - Periods up to 31 January 2025**

AU\$m	1 month	3 month	12 month
Lowest daily VWAP in period	87.1	87.1	74.3
Highest daily VWAP in period	93.9	107.9	150.5
Period VWAP	90.2	95.3	109.2
Period VWAP with 20% Control Premium	108.2	114.3	131.0

Source: BDOCF analysis

### 8.7.3 Identifying assets contributing to Xanadu's market value

Xanadu's market capitalisation reflects the value that investors assign to its portfolio of assets, which primarily consists of Xanadu's 50% interest in the Khuiten JV and Xanadu's other exploration projects. To determine the implied market value of the Khuiten JV, we must first identify and account for the value of Xanadu's other material assets.

Aside from its interest in Khuiten JV, Xanadu holds exploration-stage projects, including Red Mountain and Sant Tolgoi, which have been independently valued by a technical specialist. These assets contribute to Xanadu's total market value and must be deducted from its market capitalisation to isolate the market's implied valuation of Khuiten JV.

ERM's valuation of Xanadu's Red Mountain and Sant Tolgoi projects are summarised in Table 8.13 below. Red Mountain is valued between US\$1.5 million to US\$6.1 million while Sant Tolgoi is not attributed any value. Refer to the ERM Report in Appendix B for further information.

<sup>35</sup> Xanadu Quarterly Activities Report for the three months ended 31 December 2024



**Table 8.13: Xanadu’s value in other exploration projects**

	Low	High
Red Mountain (US\$m)	1.5	6.1
Sant Tolgoi (US\$m)	-	-
<b>Total (US\$m)</b>	<b>1.5</b>	<b>6.1</b>
AUD:USD Exchange Rate	0.62	0.62
<b>Total (AU\$m)</b>	<b>2.4</b>	<b>9.8</b>

Source: BDOCF analysis, ERM Report

#### 8.7.4 Impact of corporate overheads

Corporate overheads represent Xanadu’s ongoing corporate costs, including management expenses, ASX listing fees, and administrative costs that are not directly related to the Khuiten JV. When determining the market-implied valuation of the Khuiten JV, adjusting for corporate overheads depends on the expected timeframe for holding the JV interest and whether these costs will continue to impact shareholder value over the long term.

If Xanadu is expected to retain its interest in the Khuiten JV for the long term, corporate overheads should be deducted, as they will continue to reduce the net cash flows available to shareholders. Additionally, because Xanadu’s market capitalisation already reflects corporate overheads, an adjustment is required to isolate the market’s implied valuation of the Khuiten JV itself, as these costs do not relate to the JV’s operations. However, if the market is pricing in a corporate transaction in the near term, such as a sale of Xanadu’s JV interest or a corporate takeover, then corporate overheads may not be a material factor in the valuation. In this scenario, the market would already anticipate the removal of these costs, meaning an adjustment may not be necessary.

To account for these factors, we have considered two valuation scenarios. The first assumes a company-transforming transaction within two years, in which case corporate overheads are adjusted for two years, as they would be eliminated upon completion of the transaction. The second assumes Xanadu retains its JV interest for the long term, meaning corporate overheads will continue to be incurred until the end of the Kharmagtai Project and should be added back to remove their impact from the market-implied valuation of Khuiten JV.

Corporate overheads have been estimated at a base rate of approximately US\$3.0 million per annum under the two scenarios mentioned above. The net annual corporate overheads have been discounted at a rate of 14.5% (being the mid-point of our adopted discount rates). The discounted value for the corporate costs on this basis is approximately US\$5.3 million (AU\$8.4 million) for the two-year adjustment and US\$21.3 million (AU\$34.2 million) for the long-term adjustment.

#### 8.7.5 Market capitalisation adopted to calculate the implied market valuation of the Khuiten JV

For the purposes of cross-checking our valuation of the Khuiten JV, we have considered a market-implied valuation of the Khuiten JV interest of Xanadu with reference to market capitalisation based on:

- ▶ VWAP without a control premium, reflecting a minority trading price; and
- ▶ VWAP that incorporates a control premium of 20%.

##### *Control Premium Analysis*

A controlling interest in a company is usually regarded as being more valuable than a minority interest as it provides the owner with control over the operating and financial decisions of the company, the right to set the strategic direction of the company, control over the buying, selling and use of the company’s assets, and control over appointment of staff and setting financial policies.

The increase in value for a controlling interest is often observed where an acquirer launches a takeover bid, or some other mechanism for control, for another company. For the purposes of our research on control premiums, we have defined a controlling interest to be an interest where the acquirer has acquired a shareholding of greater than 50% in the target company.

Generally, control premiums may be impacted by a range of factors including the following:

- ▶ Specific acquirer premium and/or special value that may be applicable to the acquirer;
- ▶ Level of ownership in the target company already held by the acquirer;
- ▶ Market speculation about any impending transactions involving the target and/or the sector that the target belongs to;
- ▶ The presence of competing bids; and
- ▶ General market sentiment and economic factors.

To form our view of an appropriate range of control premium applicable for the purposes of this Report, we have considered information which includes:

- ▶ Recent independent expert’s reports which apply control premiums in the range of 20% to 40%;

- ▶ Various industry and academic research, which suggests that control premiums are typically within the range of 20% to 40%;
- ▶ Our own research on control premiums implied by the trading data of ASX listed companies. The average and median control premium found in our research are approximately within the range of 20% and 40%, based on one-day, one-week, and one-month prior trading prices;
- ▶ Various valuation textbooks; and
- ▶ Industry practice.

#### Application to Xanadu

As set out above, historically, takeovers of publicly listed mining companies have involved control premiums in the range of 20% to 40%, depending on factors such as project stage, strategic synergies, and competitive interest.

Our valuation of the Khuiten JV set out above reflects the full value of Xanadu's proportionate interest in the Khuiten JV. In circumstances where Xanadu's share trading price reflects a minority parcel of shares (which in our view it does), it would be necessary to apply a control premium to Xanadu's share trading data to enable a like-for-like comparison.

However, in this case the analysis is more complicated relative to a typical control transaction, because a third-party acquiring Xanadu's proportionate interest in the Khuiten JV will still be subject to the risks referred to in Table 8.8 above relating to the non-controlling nature of the interest in addition to illiquidity and marketability constraints.

There is also a concern that while a third-party acquirer may pay a premium to control the pace, structure, or source of funding for Xanadu's share of development costs, incorporating a premium for these items would no longer result in a like-for-like comparison as the funding risk we refer to in Table 8.8 would no longer apply.

On balance, we consider it appropriate to set out our comparison based on the share trading data without any control premium, and the share trading data applying a control premium of 20% (being the low end of the range).

#### 8.7.6 Implied market valuation of the Khuiten JV

We estimated the market valuation for Xanadu's interest in the Khuiten JV by:

- ▶ Calculating Xanadu's market capitalisation using its 1-month, 3-month, and 12-month VWAPs (as shown in Table 8.12). As set out in Section 8.7.1 above, given that Xanadu released the PFS in October 2024, we consider the 1-month and 3-month VWAPs to be the most relevant for our analysis, as they reflect trading activity following the release of the PFS. The 12-month VWAP is considered less relevant due to the potential impact of outdated market conditions however is presented for completeness;
- ▶ Increasing the market capitalisation to allow for control premium of 20% in some circumstances (refer Section 8.7.5);
- ▶ Increasing the market capitalisation to allow for corporate overheads (either two years or long term, as discussed in Section 8.7.4) to determine the enterprise value; and
- ▶ Decreasing our calculated enterprise value to deduct the value attributed to Xanadu's projects other than the interest in the Khuiten JV (refer Section 8.7.3).

The results of the above process are set out in four scenarios in Table 8.14 below.

**Table 8.14: Implied market valuation of Xanadu's share in the Khuiten JV**

Scenario (AU\$m)	Control premium	Corporate overheads	1 month VWAP	3 month VWAP	12 month VWAP
1	0%	Long term	121.9	123.3	133.5
2	20%	Long term	139.9	142.4	155.4
3	0%	2 years	96.2	97.6	107.8
4	20%	2 years	114.2	116.7	129.6

Source: BDO CF analysis

### 8.7.7 Comparison to summation valuation

Figure 8.10 below compares our calculated implied market value of Xandu’s share in the Khuiten JV based on 1 month VWAP, 3 month VWAP and 12 month VWAP, under the four scenarios in the section above, to our summation valuation of the Khuiten JV.

Figure 8.10: Xanadu’s share in the Khuiten JV - Comparison of summation value to implied market valuation

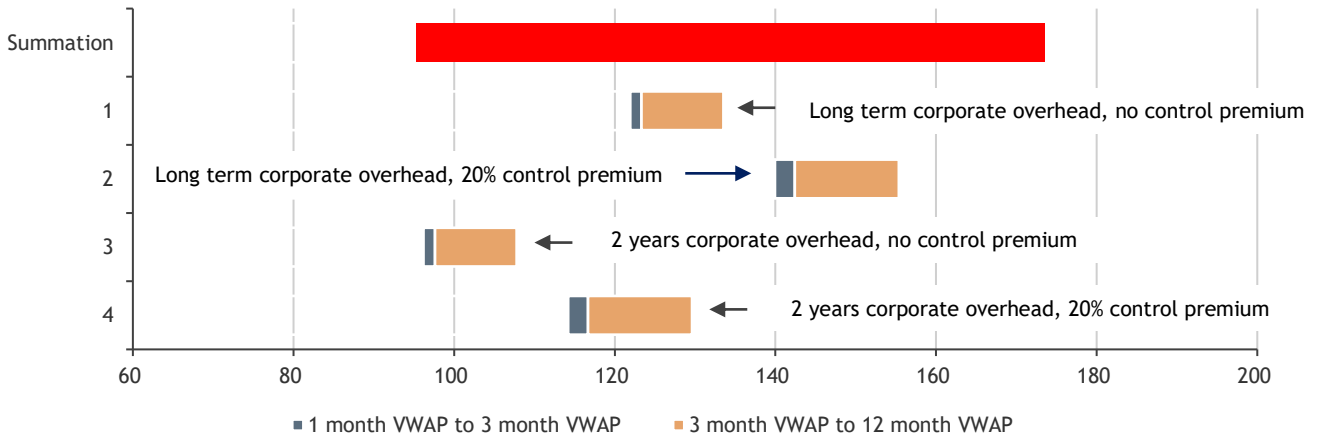

Source: BDO CF analysis

Considering our analysis set out above, we note our summation valuation range encompasses the scenarios considered (as described in Section 8.7.6). In our view, our summation valuation range is supported by our implied valuation based on a share trading valuation methodology.

For personal use only

## 9.0 Valuation of Xanadu's interest in the Khuiten JV Post the Proposed Transaction

To provide additional information to Non-Associated Shareholders, we have set out the value of Xanadu's interest in the Khuiten JV assuming that the 25% Option is exercised (i.e. the Proposed Transaction is implemented). In doing so, we have adopted the same methodology and figures as set out in Section 8 with a few specific changes.

Where the methodology has differed to that set out in Section 8, we have detailed the process of the updated methodology in line with the changes relevant to the Proposed Transaction. This is structured as follows:

- ▶ Section 9.1 sets out our conversion of the Kharmagtai Project cashflows to Xanadu's cashflows;
- ▶ Section 9.2 sets out our valuation of Khuiten JV cashflows to Xanadu;
- ▶ Section 9.3 sets out the summation valuation of Xanadu's interest in Khuiten JV; and
- ▶ Section 9.4 sets out the adjustment to enable like-for-like comparison.

### 9.1 Conversion of the Kharmagtai Project cashflows to Xanadu's cashflows

The cashflows of Xanadu attributed to the Kharmagtai Project will differ following the Proposed Transaction. The key differences (compared to Section 8.4) are summarised below, with a corresponding diagram to illustrate the overall process.

#### 9.1.1 Cashflow changes compared to prior Proposed Transaction

The cashflow adjustments can be categorised into the construction phase and the operating phase. The key adjustments include:

- ▶ **During the construction phase:** setting up a loan between Xanadu and Zijin. Zijin will contribute cash on Xanadu's behalf (25% of the total funding), compared to Xanadu providing 50% of the funding prior the Proposed Transaction. The loan will be repaid once the project starts operating, with an assumed interest rate of SOFR + 5%.
- ▶ **During the operating phase:** calculating cash distributions to Xanadu. Xanadu will receive 25% of the cash distribution from Khuiten JV (compared to 50% prior the Proposed Transaction) and will use 90% of its cash receipts to repay the loan from Zijin until it is fully repaid.

#### 9.1.2 Diagram of the key steps

Figure 9.1 below illustrates the key steps in converting the 100% Kharmagtai Project cash flows into the cash flows attributable to Khuiten JV across both phases.

Figure 9.1: Cashflows waterfall post the Proposed Transaction

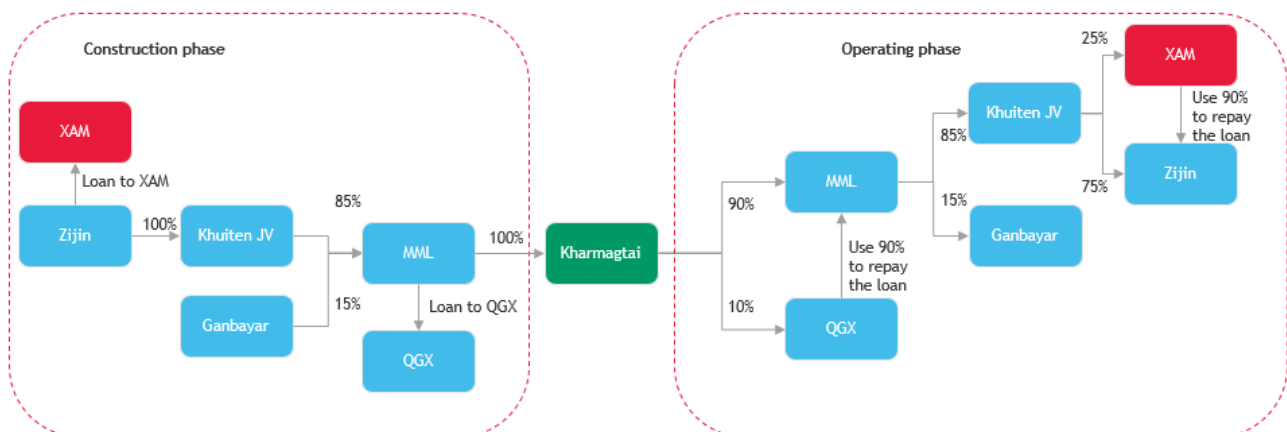

Source: BDOCF analysis

#### 9.1.3 Comparison of annual cashflows prior and post the Proposed Transaction

The comparison of Xanadu's share of the annual cashflows prior and post the Proposed Transaction is presented in Figure 9.2 below. In addition, Figure 9.2 also depicts the cumulative cash flows over the LOM for the Khuiten JV prior to and post the implementation of the Proposed Transaction.

For completeness, we reiterate that before the loan that Zijin made to Xanadu is repaid, Xanadu uses 90% of the cash flows it is entitled to for the purposes of repaying Zijin. Once this loan and accrued interest is repaid (being CY2033 based on the below assumed cash flows), Xanadu is entitled to its full cash flow entitlement.

Figure 9.2: Comparison of Xanadu's annual cashflows prior and post the Proposed Transaction

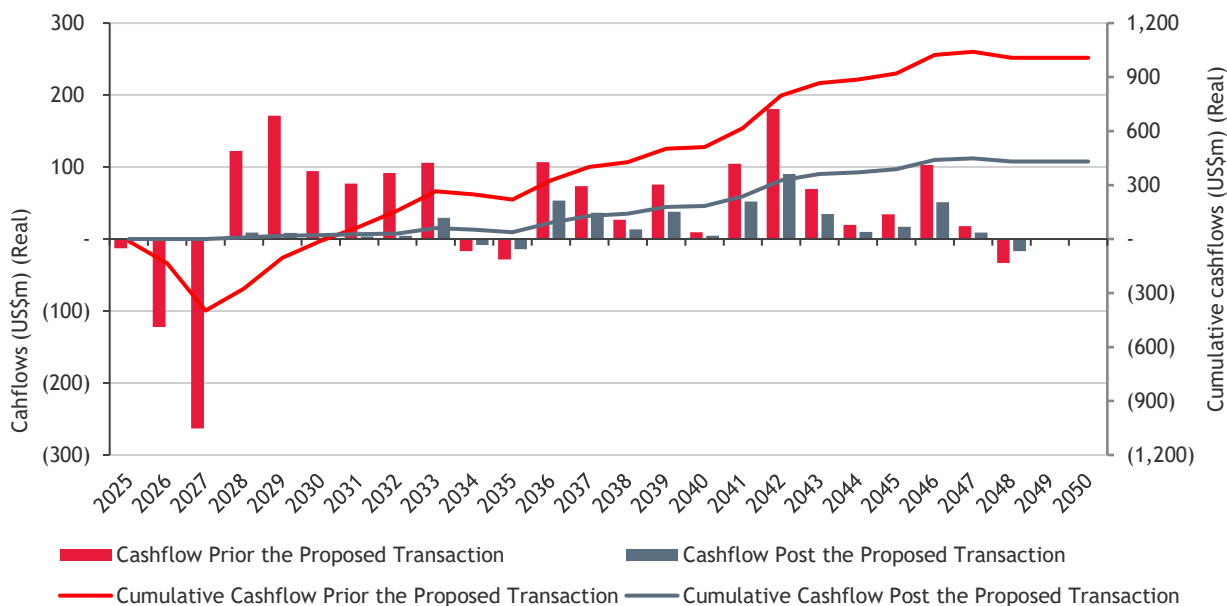

Source: BDO CF analysis

## 9.2 Value of the Khuiten JV cashflows to Xanadu

To determine the value of Xanadu's interest in Khuiten JV, we have applied a DCF valuation methodology, estimating the present value of Xanadu's share of future cash flows from the JV. This section outlines:

- ▶ The discount rate applied, reflecting the appropriate risk-adjusted return for the cash flow attributable to Xanadu, derived from its ownership in Khuiten JV;
- ▶ The value adopted, based on applying our adopted discount rate to the cash flows attributable to Xanadu; and
- ▶ A sensitivity analysis, assessing how key variables (such as discount rates, commodity prices, and cost assumptions) impact the valuation.

### 9.2.1 Discount rate adopted

We have assumed the elimination of Xanadu's funding risk post transaction, relative to the current Xanadu JV interest, does not materially change the discount rate applied to Xanadu's share of the Khuiten JV cash flows, as the fundamental project risks remain largely unchanged. While Xanadu no longer needs to fund its share of construction costs upfront, it is still ultimately responsible for these costs, as they will be recovered by Zijin from Xanadu's future cash flows. This means that Xanadu remains exposed to construction risk, including potential cost overruns and delays, as higher-than-expected development costs would extend the repayment period and reduce net distributions.

Furthermore, Xanadu's share of project cash flows remains subject to commodity price volatility and operational risks once production begins.

We also considered the impact of incorporating the proposed debt agreement between Xanadu and Zijin into our cash flow forecast and the appropriate adjustments to our adopted discount rate, which is traditionally applied to pre-debt related cash flows. We concluded that it was reasonable to make no adjustments to our adopted discount rate as:

- ▶ The debt repayments are linked to the operational success of the Kharmagtai Project and the ultimate distributions to the Khuiten JV. We believe this carries similar risk factors to those considered in adopting our discount rate range; and
- ▶ We tested alternative methodologies whereby we discounted the pre-debt cash flows and subtracted the present value face of future debt drawdowns (discounted at our adopted discount rate range) from our calculated NPV. This resulted in immaterial differences in the valuation result.

Given that the core risks driving the discount rate (e.g. construction execution, commodity price exposure, and operational performance) remain largely unchanged, there is no material basis to adjust the discount rate following the removal of Xanadu's funding risk. Instead, the impact of the elimination of the funding risk is accounted for separately through adjustments to cash flow timing and valuation discounts.

### 9.2.2 DCF valuation

We have calculated a value for Xanadu's share of the cashflows from the Khuiten JV using a DCF valuation methodology, as represented by the projected cash flows in the Financial Model across the LOM, using the assumptions stated in the preceding sections.

Table 9.1 below sets out a summary of our valuation of the cash flows. For clarity, the only difference between the low and high scenario is the discount rate applied. The low scenario uses the upper end of our discount rate range while the higher scenario uses the lower end of our discount rate range (13.0% to 16.0%, as set out in Section 8.5.1).

**Table 9.1: Xanadu's value attributable to Khuiten JV cashflows - post the Proposed Transaction**

Khuiten cash flow value to Xanadu (US\$m)	Low	High
DCF Value adopted for the cashflows	55	80

Source: BDOCF analysis

### 9.2.3 Sensitivity analysis of the DCF valuation

We have conducted a sensitivity analysis under different discount rates for the valuation of Xanadu's share of the cash flows from the Khuiten JV on the same basis as detailed in Section 8.5.3. The results are presented in Table 9.2.

**Table 9.2: Sensitivity analysis of Xanadu's value incorporated in the Financial Model**

Xanadu NPV post Transaction (US\$m)	16.0%	13.0%
Base Case	57	78
Scaling by a percentage		
Gold Pricing (+10%)	83	113
Gold Pricing (-10%)	32	44
Copper Pricing (+10%)	75	102
Copper Pricing (-10%)	40	55
OPEX (+10%)	34	47
OPEX (-10%)	81	110
CAPEX (+10%)	54	75
CAPEX (-10%)	60	82
Change by percentage points		
Copper Royalty (+5%)	43	60
Copper Royalty (-5%)	71	97

Source: BDOCF analysis

## 9.3 Value of Xanadu's interest in the Khuiten JV

### 9.3.1 Xanadu's remaining assets and liabilities

We have relied on ERM's valuation for the resources not incorporated in the DCF model. To ensure a consistent pre- and post-transaction valuation, we have assumed the same underlying balances as at 31 December 2024, with the only difference being the ownership structure applied. If Xanadu Non-Associated Shareholders approve the Proposed Transaction, Xanadu's interest in the Khuiten JV will reduce from 50% to 25%, and accordingly, the value attributed to Xanadu would be between US\$10.5 million and US\$18.0 million. Similarly, while the Khuiten JV had AU\$0.6 million (US\$0.4 million) in cash as at 31 December 2024, for comparison purposes, we have applied the post-Proposed Transaction ownership structure, resulting in Xanadu's proportionate share being US\$0.1 million.

### 9.3.2 Xanadu's interest in the Khuiten JV before adjustments for marketability and control

Table 9.3 below presents Xanadu's interest in Khuiten JV before marketability and control adjustments.

**Table 9.3: Xanadu's interest in Khuiten JV**

US\$m	Reference	Low	High
Khuiten JV DCF's value	Section 9.2.2	55.0	80.0
Other resources not incorporated in the DCF model	Section 9.3.1	10.5	18.0
<b>Enterprise Value</b>		<b>65.5</b>	<b>98.0</b>
<b>Add/(less) surplus assets/(liabilities)</b>			
Cash @25%	Section 9.3.1	0.1	0.1
<b>Khuiten Equity Value</b>		<b>65.6</b>	<b>98.1</b>

Source: BDOCF analysis

### 9.3.3 Adjustments to Xanadu's pro rata valuation of Khuiten JV for marketability and control

Following the Proposed Transaction and the elimination of Xanadu's funding risk, we have derived a DCF-based valuation of the future cash flows attributable to Xanadu's interest in the Khuiten JV along with Xanadu's proportionate share of other assets and liabilities within the Khuiten JV.

Similar to Section 8.6.5 above, this valuation reflects a pro-rata share of Khuiten JV's value and further adjustments are required to account for constraints, including liquidity, marketability, and the impact of the deferred funding recovery resulting from the elimination of Xanadu's funding risk. These adjustments, specifically those that will change following the Proposed Transaction are discussed further in Table 9.4 below.

**Table 9.4: Qualitative considerations in relation to the control, marketability and liquidity of Xanadu's interest in the Khuiten JV**

Category	Description
Non-controlling nature of the interest	<p>The Khuiten JV has an interest in the Kharmagtai Project of approximately 76.5% which will not be impacted by the Proposed Transaction. However, following the Proposed Transaction, Xanadu's interest will decrease from a 50% to a 25% interest in the Khuiten JV, or a change in indirect interest in the Kharmagtai Project from 38.25% to 19.13%.</p> <p>Relative to the considerations listed in Table 8.8 of this Report, we note the following changes resulting from Xanadu's decreased ownership interest in the Khuiten JV:</p> <ul style="list-style-type: none"> <li>▶ Xanadu will only be able to appoint a single Director whereas Zijin will have the right to appoint three Directors. Zijin will control voting rights on a 3:1 basis; and</li> <li>▶ Xanadu will have no further funding obligations before commencement of commercial production.</li> </ul> <p>Overall, we consider that Xanadu will have less influence on the Khuiten JV's Board decisions relative to prior to the Proposed Transaction. Noting that there was shared control, at best, prior to the Proposed Transaction, we do not consider the reduction to be particularly large.</p>
Illiquidity and marketability constraints	<p>Following the Proposed Transaction, Xanadu's interest in the Khuiten JV will continue to be a minority interest in a private, non-traded JV. We do not consider there will be a material change in the factors impacting illiquidity and marketability constraints.</p>
Funding and dilution risk - Xanadu level	<p>The elimination of Xanadu's immediate need to fund the Company's share of development CAPEX removes the dilution risk previously incorporated.</p>

Source: BDOCF analysis

On balance, we consider it reasonable to increase the discount for marketability and lack of control from 15% pre the Proposed Transaction to 17.5% post the Proposed Transaction. We also consider it reasonable to remove the discount for funding and dilution risk.

### 9.3.4 Valuation of Xanadu's interest in Khuiten JV

Table 9.5 sets out our valuation of Xanadu's interest in Khuiten JV.

**Table 9.5: Valuation of Xanadu's interest in the Khuiten JV**

	Reference	Low	High
Khuiten Equity Value (\$USm)	Section 9.3.2	65.6	98.1
Marketability and (lack of) control discount	Section 9.3.3	17.5%	17.5%
Funding and dilution discount	Section 9.3.3	0.0%	0.0%
<b>Khuiten Equity Value (\$US'm)</b>		<b>54.1</b>	<b>80.9</b>
AUD:USD Exchange Rate		0.62	0.62
<b>Khuiten Equity Value (AU\$m)</b>		<b>86.9</b>	<b>130.0</b>

Source: BDOCF analysis

## 9.4 Adjustment to enable like-for-like comparison

Following the Proposed Transaction, we have added US\$25 million to Xanadu's valuation to reflect the cash proceeds received from the sale of a 25% interest in the Khuiten JV. This adjustment ensures a like-for-like comparison between:

- ▶ Xanadu's pre the Proposed Transaction valuation, where it holds a 50% interest in Khuiten JV with full funding obligations; and
- ▶ Xanadu's post the Proposed Transaction valuation, where it retains a 25% interest without development funding risk and receives US\$25 million in upfront cash.

Adding US\$25 million to our valuation results in a total value range of US\$79.1 million to US\$105.9 million for Xanadu post-transaction. By making this adjustment, we ensure the valuation appropriately reflects both the ownership change and the structural shift in future cash flows. The comparison of Xanadu's value in Khuiten JV prior and post the Proposed Transaction is summarised in Table 9.6 below.

**Table 9.6: Comparison of Xanadu's value in Khuiten JV prior and post the Proposed Transaction**

US\$m	Reference	Low	High
Xanadu's interest in Khuiten JV prior the Proposed Transaction	Section 8.6.5	59.3	108.0
<b>Total Xanadu's value in Khuiten JV prior the Proposed Transaction</b>		<b>59.3</b>	<b>108.0</b>
Xanadu's interest in Khuiten JV post the Proposed Transaction	Section 9.3.4	54.1	80.9
Cash proceeds		25.0	25.0
<b>Total Xanadu's value in Khuiten JV post the Proposed Transaction</b>		<b>79.1</b>	<b>105.9</b>

Source: BDOCF analysis

For personal use only



## APPENDIX A: GLOSSARY

Reference	Definition
25% Put Option, the	Put option granted by Zijin Mining Group to Xanadu Mines Ltd to require Zijin to purchase 50% of all shares owned by Xanadu in the Khuiten Joint Venture in exchange for \$25 million
50% Put Option, the	Put option granted by Zijin Mining Group to Xanadu Mines Ltd to require Zijin to purchase all shares owned by Xanadu in the Khuiten Joint Venture in exchange for \$50 million
Au	Gold metal
AU\$ or \$	Australian dollar
ABV	Asset-based valuation
AFCA	Australian Financial Complaints Authority
APES 225	Accounting Professional and Ethical Standards Board professional standard APES 225 <i>Valuation Services</i>
ASIC	Australian Securities and Investment Commission
ASX	Australian Securities Exchange
BDO Persons	The partners, directors, agents or associates of BDO
BDOCF	BDO Corporate Finance Ltd
BFS	Bankable Feasibility Study
Board, the	The board of directors of the Company
CAPEX	Capital expenditure
CAPM	Capital asset pricing model
CME	Capitalisation of maintainable earnings
Company, the	Xanadu Mines Limited
Corporations Act, the	The Corporations Act 2001
COMEX	The Commodity Exchange
Cu	Copper Metal
CuEq	Copper equivalent grade
CY	Calendar year ended on 31 December
DCF	Discounted cash flow
Decision to Mine	The first decision by the Board to proceed with a commercial mining development on the licence for the Kharmagtai Project
EBIT	Earnings Before Interest and Tax
EBITDA	Earnings Before Interest, Tax, Depreciation and Amortisation
E&E	Exploration and evaluation
ERM	ERM International Group Limited
ERM Report, the	ERM's technical expert report
EV	Enterprise value
FID	Financial Investment Decision
Financial Model, the	The financial model adopted for our valuation purposes

For personal use only

Reference	Definition
FSG	Financial Services Guide
FY	The financial year or 12-month period ended on 30 June
HKD	Hong Kong dollar
ICSG	International Copper Study Group
IVSC	International Valuation Standards Council
JOGMEC	Japan Oil Gas and Metals National
JV	Joint venture
JV Agreement	The formation of a 50:50 JV via the JV Agreement and through Xanadu's previously 100% owned subsidiary Khuiten
Kharmagtai Project, the	The Kharmagtai copper-gold project located in Omnogovi Province, approximately 420km southeast of Ulaanbaatar in Mongolia
Khuiten	Khuiten Metals Pte Ltd
Khuiten JV	The 50/50 JV between Zijin and Xanadu
LOM	Life-of-mine
Management	Xanadu management
M	Metre
Meeting, the	General meeting to be held on or around 10 April 2025
Mlbs	Million pounds
Moz	Million ounces
MML	Mogol Metals LLC
Mt	Million tonnes
Mtpa	Million tonnes per annum
Non-Associated Directors	The non-associated Xanadu directors
Non-Associated Shareholders	The non-associated Xanadu shareholders.
Notice of Meeting, the	The Notice of Meeting and Explanatory memorandum dated 12 March 2025 prepared by Xanadu Mines Limited
NPAT	Net profit after tax
NPV	Net present value
NSR	Net smelter return
OPEX	Operating expenditures
OU	Oyut Ulaan LLC
PFS	The Pre-Feasibility Study released by Xanadu in October 2024
Prime Rate	Prime rate of the Bank of Montreal
Proposed Transaction, the	The exercise of the Put Option to sell 25% of the shares in the Khuiten JV to Zijin in exchange for \$25 million and a loan to fund the development of the Kharmagtai Project.
Red Mountain	Red Mountain copper-gold project

Reference	Definition
Regulations, the	The Corporation Regulations 2001
Report, this	This independent expert's report prepared by BDOCF and dated 11 March 2025
Reserves Model, the	Kharmagtai PFS Model (Reserves Only).xlsx
Resources Model, the	Kharmagtai PFS Fin Model V10 Base Case 15_Project_Reviews_SCV10A - silver.xlsx
RG 111	Regulatory Guide 111: <i>Content of Expert Reports</i> , issued by ASIC
RGs	Regulatory guides published by ASIC
Sant Tolgoi	Sant Tolgoi copper-nickel project
Shareholders, the	The holders of fully paid ordinary shares in the Company
Simplified Model, the	Kharmagtai PFS Model (Simplified Version).xlsx
SOFR	Secured Overnight Financing Rate
Substantial Asset	Assets value or the consideration for it is, or in ASX's opinion is, 5% or more of the value of the equity interests of the entity, as set out in the latest accounts given to the ASX in accordance with the ASX listing rules
Substantial Holder	Person who has relevant interest, or had a relevant interest at any time in the six months before the transaction, in at least 10% of the voting power of the company
TSX	Toronto Stock Exchange
Xanadu	Xanadu Mines Ltd
US\$	United States dollar
VALMIN Code	The code for the Technical Assessment and Valuation of Mineral and Petroleum Assets and Securities for Independent Specialist Reports
VAT	Value added tax
VWAP	Volume weighted average price
WACC	Weighted average cost of capital
We, us, our	BDO Corporate Finance Ltd
Zijin	Zijin Mining Group

**APPENDIX B: INDEPENDENT TECHNICAL EXPERT'S REPORT -  
ERM REPORT**

For personal use only



# Independent Technical Assessment and Valuation

Kharmagtai, Red Mountain and Sant  
Tolgoi Projects, Mongolia

PREPARED FOR

XANADU MINES

Xanadu Mines Limited

DATE

11 March 2025

REFERENCE

0762235

ERM REPORT

R102.2025

For personal use only



## DOCUMENT DETAILS

DOCUMENT DETAILS	
DOCUMENT TITLE	Independent Technical Assessment and Valuation
DOCUMENT SUBTITLE	Kharmagtai, Red Mountain and Sant Tolgoi Projects, Mongolia
PROJECT NUMBER	0762235
REPORT NUMBER	R102.2025
DATE	11 <sup>th</sup> March 2025
VERSION	1.4
EFFECTIVE DATE	25 <sup>th</sup> February 2025
AUTHOR(S)	Andrew Waltho, Khairulla Aben, Max Nind, Trivindren Naidoo, Robert Kochmanski, Graham Jeffress
CLIENT NAME	Xanadu Mines Limited

## DOCUMENT HISTORY

REVISION HISTORY				
VERSION	REVISION	AUTHOR	REVIEWED BY	COMMENTS
0	1	Andrew Waltho	Graham Jeffress	Initial Draft
0	2	Andrew Waltho	Graham Jeffress	Draft for client review and feedback
0	3	Andrew Waltho	Graham Jeffress	Draft for client review and feedback
0	4	Andrew Waltho	Trivendren Naidoo	Draft incorporating ERM peer review and Expert comments
1	0	Andrew Waltho	Trivendren Naidoo	Draft incorporating ERM peer review and Expert comments
1	1	Andrew Waltho	Trivendren Naidoo	Final Draft incorporating changes requested by Expert
1	2	Andrew Waltho	Graham Jeffress	Final Draft incorporating additional changes requested by Expert
1	3	Andrew Waltho	Graham Jeffress	Final draft incorporating changes proposed by Xanadu management with which ERM agrees
1	4	Andrew Waltho	Graham Jeffress	Incorporation of additional changes in final draft following ASX review

## REPORT PREPARED FOR

COMMISSIONING ENTITY	BDO Corporate Finance Ltd
CONTACT	Mark Whittaker
TITLE	Partner, Advisory, Deal Advisory

<b>COMMISSIONING ENTITY</b>	<b>BDO Corporate Finance Ltd</b>
<b>ADDRESS</b>	Level 10, 12 Creek St, Brisbane QLD 4000, Australia
<b>CLIENT</b>	<b>Xanadu Mines Limited</b>
<b>CLIENT CONTACT</b>	Spencer Cole
<b>CONTACT TITLE</b>	Chief Development Officer and Chief Financial Officer
<b>ADDRESS</b>	L12, 680 George St, Sydney NSW 2000 Australia Suite 23 Building 9B, Olympic Street, Khoroo 1, Sukhbaatar District, Ulaanbaatar 14240 Mongolia
<b>CONTACT EMAIL</b>	info@xanadumines.com
<b>CONTACT TELEPHONE</b>	+61 (0) 2 8280 7497
<b>CLIENT NAME</b>	Xanadu Mines Limited
<b>CLIENT ACRONYM/ASX CODE</b>	XAM





## EXECUTIVE SUMMARY

### Overview

Xanadu Mines Ltd (XAM, "Xanadu" or "the Company") is an ASX listed exploration company focused on discovery and definition of porphyry copper-gold and epithermal-style gold deposits in Mongolia. The Company maintains a multistage portfolio of exploration projects.

This report has been prepared to meet the requirements of a public document for the information of XAM shareholders in considering a major transaction proposed by the Company. This transaction is the execution of an option that would result in the sale of half its share in the Kharmagtai project to Zijin Mining Group Ltd ('Proposed Transaction'). BDO Corporate Finance Ltd (BDO) has been engaged by XAM to prepare an Independent Expert's Report (BDO IER) for inclusion within a Notice of Meeting to be provided to the shareholders of the Company. The BDO IER is required to provide an opinion on whether the proposed transaction is fair and reasonable to non-associated shareholders. ERM was instructed to prepare an Independent Technical Specialists' Report (ITSR) for the three projects meeting the requirements of the VALMIN Code (2015). ERM's report supports the work of BDO by providing an opinion of the value of the projects, and of parameters used in a financial model for the Kharmagtai project. The Report, or a summary of it, is to be appended to the IER, and as such, will become a public document.

ERM gives consent to BDO to use the report for the purposes stated within the scope. The Report is not to be used for purposes outside of these scope without ERM's written consent.

XAM's three projects comprise one advanced (Kharmagtai) and two earlier stage exploration opportunities (Red Mountain and Sant Tolgoi) in Mongolia. Kharmagtai and Red Mountain are located in South Gobi province. Sant Tolgoi is located in northwestern Mongolia, in Zavchan Province, close to Mongolia's border with Russia.

This report incorporates:

1. a review of the geology and mineral exploration potential of each of XAM's three projects in Mongolia
2. compliance with the JORC Code in preparing and classifying Mineral Resources and Ore Reserves for the Kharmagtai project
3. a review of mining and metallurgical options examined for the Kharmagtai project Prefeasibility Study (PFS)
4. review and validation of key mining and metallurgical parameters used in financial models prepared as part of the project's PFS
5. estimation of the market value of the Kharmagtai Mineral Resource excluded from Ore Reserves
6. preparation of valuation opinions for XAM's Red Mountain and Sant Tolgoi mineral exploration projects

An income-based valuation for the Kharmagtai project will be completed by BDO Australia, XAM's Expert engaged to assist in informing shareholders of a major transaction for which XAM requires shareholder approval. This valuation will be based on the project's Ore Reserve

For personal use only



reported in the project's PFS. ERM will provide an opinion on additional value contributed by publicly reported Mineral Resources not included in the Ore Reserve.

The Red Mountain and Sant Tolgoi exploration projects have been valued by ERM using several different approaches to provide insight into the impacts of varying parameters used in valuation opinion development.

This report's authors and reviewers have no previous association with XAM. Neither ERM nor the authors and reviewer of this report, have or have had previously, any material interest in XAM or the Company's operations and exploration projects that form the subjects of this report.

The effective date of this report is 25<sup>th</sup> February 2025. The report uses information provided to ERM by XAM prior to 30 November 2024, in addition to information obtained by ERM from other sources.

Site visits were not conducted in the course of preparing this report due to logistical issues with accessing the three exploration sites during the winter in Mongolia. The limited information that would be obtained by visiting exploration sites with no current activity was also not considered likely to be material to the outcomes of this report.

ERM's valuation opinions are based on both public and non-public information. The information available is the product of reasonable enquiries within the time available, to confirm the authenticity and completeness of the technical data and other relevant information used.

The valuations discussed in the report are opinions as to likely values, not absolute values, which can only be tested by going to the market.

XAM's Red Mountain project is 100% owned. The Kharmagtai project is a joint venture in which XAM is the operator and has equity defined by the agreement. Sant Tolgoi is an exploration project in which XAM has the ability to earn equity by meeting exploration expenditure commitments defined in terms of required expenditures within specified timeframes. XAM's involvement in each project is either direct or through a wholly-owned subsidiary company.

### *Kharmagtai Project*

The Kharmagtai copper-gold project is considered by Xanadu to be the Company's flagship asset. It is located in South Gobi (*Omnogovi*) Province, approximately 420 km southeast of the Mongolian capital, Ulaanbaatar. The project is within the South Gobi porphyry copper province which hosts several major porphyry deposits including the Oyu Tolgoi copper-gold operations (120 km south) and Tsagaan Suvarga porphyry copper-molybdenum development (170 km east).

The Kharmagtai project is owned 38.25% by Xanadu, 38.25% by Zijin Mining Group Co. Ltd (Zijin), 13.5% by Xanadu Executive Director Ganbayar Lkhagvasuren, and 10% by QGX Ltd Through its 50% ownership of the Singaporean holding company Khuiten Metals Pte Ltd, Xanadu shares control of the project with its joint venture (JV) partner Zijin. Xanadu was the operator of the project for the PFS released in October 2024.

Mineralisation at Kharmagtai is porphyry copper-gold style, related to a series of co-genetic porphyry centres. Distal gold-base metal-bearing breccia pipes and complex silicified structurally controlled breccia zones and younger tourmaline breccia also occur. Kharmagtai is

For personal use only



a large and complex system, considered to have further, untested exploration potential at its current stage of exploration and development.

### Red Mountain Project

The Red Mountain porphyry copper-gold project (100% XAM) is located within the Dornogovi Province of southern Mongolia, approximately 420 km southeast of Ulaanbaatar.

The porphyry mineralisation at Red Mountain is associated with late-stage monzonite and quartz diorite porphyry dykes and stocks emplaced on the flanks of the Red Mountain Intrusive Complex (RMIC). Alteration and mineralisation at Red Mountain are characterised by multiple co-genetic copper-gold porphyry centres, tourmaline breccia pipes and copper-gold/base metal magnetite skarns. Initial drilling has identified significant, shallow mineralisation spanning four prospects.

### Sant Tolgoi Project

The Sant Tolgoi project covers two granted exploration licences, with a combined area of over 40 km<sup>2</sup>, considered by XAM to be highly prospective for new magmatic intrusion-related copper-nickel systems. In early 2024, Xanadu executed a binding agreement with STSM LLC (STSM) granting the right to earn up to an 80% interest in these two exploration licences.

The Sant Tolgoi project is interpreted to lie on the western extension of the deep seated Khangai Fault systems, a metalliferous fault network which hosts several significant mafic and ultramafic intrusions that are considered to be encouraging for intrusion hosted copper and nickel mineralisation.

### Kharmagtai Project Technical Assessment

#### Mineral Resource Review

The geological model and associated MRE are considered by ERM to comprise a suitable basis for estimation of Ore Reserves and the project's PFS. ERM would prefer a resource estimate associated with a greater degree of confidence in the form of some Measured Resources and a greater proportion of Indicated Mineral Resources in the portions of the deposit potentially amenable to open cut mining. This is particularly the case where ore is proposed to be mined during the capital payback period for the project. Additional drilling and sampling required to achieve this should be considered by XAM prior to completion of the project's Feasibility Study.

ERM proposes that the project's Mineral Resource and Ore Reserves have been prepared, classified and reported in accordance with the requirements of the JORC Code (JORC, 2012).

#### Mining Review

ERM reviewed proposed mining options and plans for the Kharmagtai project and validated inputs to the project financial model.

From a mining engineering viewpoint

- The Kharmagtai project is a large copper project suitable for open pit mining. In the first few years, the stripping ratio is around 0.65 tonnes of waste per tonne of ore, lowering the operating costs.

For personal use only

- Contractor Mining is favoured by XAM to reduce the project's capital expenditure (CAPEX) requirements, while ensuring efficient execution of a large scale, open cut mining operation.

Some of the key comments are:

- the overall initial CAPEX for the Kharmagtai project is significantly lower than that estimated for similar projects in the region. ERM was able to determine, however, that costs have been estimated using a rigorous process that conforms with mining industry best practice and accepts the estimate presented in the project's PFS.
- Estimated operating costs (OPEX) for the Kharmagtai project are lower than for comparable open cut porphyry copper mining projects in Mongolia but have been rigorously estimated and are supported by ERM.
- Royalties were assumed at 8.36% for Cu and 5% for Au. Royalty rates in Mongolia, however, depend on metal prices and can, in practice, reach 20% when the Cu price is above US\$9,000/t, which is the case in the Kharmagtai PFS. Royalties will also be levied on trace metals present in concentrates exported from Mongolia. This does not appear to have been considered in the project financial model. The royalties payable by the project will ultimately be set by the investment agreement negotiated between XAM and the Mongolian government. The royalty rate proposed in the PFS is considered by ERM to be achievable.
- There is an apparent mismatch between the shovel size selected for the project and the proposed mining bench height of 10m. A higher bench height would be more efficient and reduce operating costs with the equipment selected.
- Options for reducing the quantity of ore moved to and from stockpiles over the life of the mine needs to be reduced to improve project economics. This needs to be addressed during a future Feasibility Study for the project.

ERM was concerned that the capital cost estimate for the project was significantly lower than for comparable projects in the region, with the apparent difference not adequately explained by the use of contract vs owner-operated mining. Discussions with consultants engaged by XAM to complete the Kharmagtai project alleviated these concerns, with the process followed in preparation of the PFS considered by ERM to follow industry best practice.

ERM agrees with the mining operating cost estimate provided by the Kharmagtai project PFS.

Royalty rates assumed by the Kharmagtai PFS are lower than those published in the Mineral Law of Mongolia, but ERM recognises that royalty rates are negotiable in investment agreements between developers and the government, and the Mongolian government is focused in growing the country's mining industry. No current copper mine in Mongolia is subject to the royalties set out in the current Mineral Law.

A closure cost of US\$106M is used in the Kharmagtai financial model. ERM considers this appropriate. Closure costs, however, will require closer consideration in the project's Feasibility Study.

### Metallurgy and Processing

The Kharmagtai project is the only one of XAM's three projects in Mongolia with metallurgical testing and development and an associated processing flow sheet. The metallurgical test work



conducted both by XAM and previous owners has been quite extensive over the period of development from 2008 to 2024. The many ore types identified have been observed to be represented over the years of development.

The test work conducted, and metallurgical knowledge observed around the project is of a high standard for this stage of study.

Metallurgical test work on treating the oxide components of the orebody and tailings stream from the sulphide flotation plant has focused around predominately Au recovery.

ERM considers CAPEX estimates for the Kharmagtai metallurgical plant to be robust. Construction direct costs outside of equipment costs appear to be lower than those observed in western countries, and it is believed to be due to lower labour rates for construction.

Operating costs appear to be relatively low for a metallurgical flow sheet of the complexity proposed for Kharmagtai. Power and reagents are the largest costs.

The general philosophy and methodology of the documented estimate is in line with industry standards.

ERM find that the manning estimates are in line with expectations of an operation of this size and complexity with experienced operators.

Some maintenance costs appear to be lower than would be expected, but the overall impact of these issues would be within levels of accuracy required of PFS studies.

Plant operations have been included in the financial model using a yearly schedule. Mine to stockpile, Mine to plant and stockpile to plant have been incorporated. On a PFS stage of the project this level of definition (yearly) is more than adequate to assess the overall financial state of the project.

Smelting and refining costs included in the Kharmagtai financial model are considered reasonable by ERM. These costs, however, represent negotiated agreements between miners and individual smelters and are not exclusively related to smelting and refining costs.

### Valuation Opinion

At the effective date of this report (25<sup>th</sup> February 2025):

- The Consensus Economics reported a spot copper price of US\$9,291 per tonne. Forecast prices between March 2025 and December 2026 ranged from US\$9,201 and US\$9,590 per tonne. This compares with the London Metals Exchange (LME) official copper bid price of US\$9,494.50 per tonne (LME, 2025) for 25 February 2025. ERM has used the Consensus Economics price for 17 February 2025 throughout this report.
- The spot gold spot price reported by Consensus Economics was \$US2,901 per ounce. Forecast gold prices between March 2025 and December 2026 published in the February 2025 survey report ranged from US\$2,681 to US\$2,767 per ounce. This compares with a gold spot price of US\$2916.50 per ounce (Trading Economics, 2025) for 25 February 2025. Again, the Consensus Economics price reported in their February 2025 survey has been used throughout this report.
- the US-Australian dollar exchange rate was 0.6351 (Reserve Bank of Australia, 2025).

For personal use only

The copper price is predicted to exceed US\$9000 per tonne by Consensus Economics throughout 2025 and 2026.

A search for comparable copper project transactions for porphyry-style mineralisation was conducted using the S&P Capital IQ database. ERM elected to confine the search to Mongolia and Kazakhstan, and between 2000 and 2024, the period for which ERM has data available and which coincided with these countries' transition to market economies from centrally planned, Soviet-style systems.

The identified transactions are concentrated between 2014 and 2017, which represent a period of intense interest in mining investment in central Asia, which has declined noticeably in subsequent years due to changes in royalty and company taxation regimes in Mongolia and investment conditions in Kazakhstan (Meja & Aliakbari, 2024). This results in most comparable transactions falling within this period. Changes to the Mining Law and other economic legislation and regulations have been implemented in Mongolia since then but their impact on the potential market value of projects is difficult to assess.

Mongolia was ranked 63 and Kazakhstan 79 for mining investment attractiveness, and 82 and 69 for government policy perception of 86 countries covered by the 2023 Fraser Institute survey. This is despite both countries being ranked favourably in terms of mineral potential (31 and 58 for Mongolia and Kazakhstan respectively of 58 countries for which survey submissions were received). These events have influenced the availability of comparable transactions able to be used in valuing XAM's mineral assets in Mongolia.

The Kharmagtai project Ore Reserve represents the most significant source of potential value in XAM's project portfolio. ERM is satisfied capital and operating costs (mining and processing) have been estimated with appropriate rigour.

### Comparable Transactions

Projects with comparable contained metal contents to Kharmagtai, with both Ore Reserves and Mineral Resources in Mongolia and Kazakhstan since 2007 have changed ownership for between approximately US\$13.0 million and US\$79 million in 2024-dollar terms. ERM proposes that, empirically, using the limited comparable transaction information available, the Kharmagtai project would attract investment of around US\$49 million ( $\pm 25\%$ , or between US\$37 and US\$61 million) on a 100% equity basis.

ERM proposes a value of US\$2.0 million for Red Mountain, which is at the top of the comparable transactions range but is considered to reflect the advanced status of the project. This valuation would be superseded by valuations based on exploration results and identified Mineral Resources when a Mineral Resource Estimate (MRE) is released for the project by XAM.

### Prospectivity Enhancement Multiplier Valuation Opinions

For Kharmagtai, ERM proposes a Prospectivity Enhancement Multiplier (PEM) of 2.5 for the project, consistent with drilling outside the area where an Ore Reserve has been identified leading to delineation of areas where additional drilling is expected to result in recognition of additional Mineral Resources able to form the basis of additional Ore Reserves. This provides a valuation opinion of US\$26.8 million in which XAM has 38.25% equity following the recent acquisition of a 38.25% interest in the project by Zijin Mining by diluting XAM's equity, equivalent to US\$10.3 million (between \$10.1 million and \$10.4 million).

For personal use only



The Red Mountain project is considered to have a prospectivity multiplier valuation opinion of between US\$5.5 and US\$6.1 million using a PEM approach. The project is considered by ERM to be highly prospective with continued exploration expected to permit release of Mineral Resource estimates for several prospects, which would further enhance project value.

### Valuation Opinion—Sant Tolgoi

Sant Tolgoi is subject to a newly formed JV between XAM and STSM in January 2024 (Xanadu Mines Ltd, 2024a) to earn up to 80 per cent of the project by meeting the requirements of several agreed stages (Philipps, 2024). XAM is, essentially, in the first stage of the agreement which will entitle it to a 51% interest in the project upon expenditure of US\$2 million on exploration within two years (by January 2026). Initial exploration results were released by XAM to the ASX in November 2024 (Xanadu Mines Ltd, 2024c).

At the date of this report, although XAM is progressing towards securing a 51% interest in the Sant Tolgoi project, the Company has no interest that can be preserved and traded with third parties until the initial JV milestone is achieved. The agreement is also yet to be formalised through a formal JV agreement executed by both XAM and STSM.

ERM is unable to attribute value to XAM's interest in the project until the requirements of the first stage of the JV are achieved.

### Valuation Opinion Summary

A summary of valuation opinions for XAM's exploration assets are presented in the following table below.

The Kharmagtai Ore Reserve, to be valued by BDO, is expected to represent the greatest source of value for the project.

Project valuation opinions based on comparable transactions are considered to represent market values. These are considerably lower than the technical values obtained using the Exploration Prospectivity Enhancement Approach, interpreted to reflect negative sentiment towards exploration and mining investment in Mongolia. The surveys that provide evidence of this are surveys of exploration and mining managers and investors in western countries, especially Canada, USA and Australia, which may express different sentiment to their counterparts in Mongolia, Kazakhstan and China. Companies based in western countries, however, are major sources of capital for investment in exploration and mining projects. Investment attractiveness has an undeniable influence on the market value of projects.

There is upside in the valuation opinions expressed in the table that will be realised on the public reporting of Mineral Resources for the Red Mountain project and successful completion of the initial stage of the Sant Tolgoi JV.

For personal use only

Value Source	Equity	Low	Preferred	High	Notes
	(%)	(US\$M)	(US\$M)	(US\$M)	
Kharmagtai comparable transactions	100.0	56	75	94	XAM has entered a JV with Zijun Mining that distributed XAM's former 76.5% equity in the project between the two groups. Shareholdings of other JV participants were not affected. The value quoted is based on the project's Mineral Resource exclusive of Ore Reserves.
	38.25	21	29	36	
Kharmagtai Prospectivity Enhancement Multiplier	100.0	26.4	26.8	27.1	XAM were contributing all exploration funds prior to the Zijin Mining agreement.
	38.25	10.1	10.3	10.4	
Red Mountain comparable transactions	100.0	1.5	2.0	3.2	Pre-resource exploration project, opinion based on limited suitable transactions.
Red Mountain Prospectivity Enhancement Multiplier	100.0	5.5	5.8	6.1	XAM is contributing all exploration funds.

ERM considers the PFS prepared for the Kharmagtai project to be an effective and accurate description of development options for the Kharmagtai project. Inputs to the financial models prepared for the project are also considered to be defensible and a suitable basis for further studies. Uncertainty exists regarding several important factors, including royalties and the project's cost of capital. The assumptions made in the PFS are considered to be well considered by ERM and able to be revised as necessary prior to completion of the project's FS.

Red Mountain is able to be valued as an exploration using market value and expenditure approaches. ERM expects that modest additional exploration will provide a basis for public reporting of a Mineral Resource Estimate for the project which will provide additional valuation options and enhance project value.

XAM have yet to reach a stage in the Sant Tolgoi JV agreement to secure equity in the project. Reaching this milestone will enable value to be ascribed to the project.



## CONTENTS

<b>EXECUTIVE SUMMARY</b>		<b>V</b>
<b>1.</b>	<b>INTRODUCTION</b>	<b>20</b>
1.1	SCOPE OF WORK	20
1.2	EFFECTIVE DATE	21
1.3	APPROACH	21
1.4	COMPLIANCE WITH THE JORC AND VALMIN CODES	21
1.5	PRINCIPAL SOURCES OF INFORMATION	21
1.6	SITE VISIT	22
1.7	COMMODITY PRICES	22
1.8	EXCHANGE RATES	22
1.9	REPORT AUTHORS -QUALIFICATIONS, EXPERIENCE AND COMPETENCE	22
1.9.1	Report Authors	22
1.9.2	Report Author Responsibilities	24
1.10	PRIOR ASSOCIATION AND INDEPENDENCE	25
1.11	DISCLAIMERS	25
1.12	CONSENT	26
<b>2.</b>	<b>MINERAL ASSET VALUATION PRINCIPLES</b>	<b>27</b>
2.1	BASIC PRINCIPLES	27
2.2	VALUATION METHODS FOR MINERAL ASSETS	28
2.3	VALUATION APPROACHES BY ASSET STAGE	28
2.4	INCOME	29
2.4.1	Discounted Cash Flow/Net Present Value Method	29
2.5	MARKET	30
2.5.1	Comparable Transaction Method	30
2.5.2	Rule of Thumb (Yardstick)	31
2.6	COST	31
2.6.1	Appraised Value or EXPLORATION EXPENDITURE APPROACH	31
2.6.2	Geoscience Factors	32
2.6.3	Geological Risk Method	35
<b>3.</b>	<b>XANADU MINES BACKGROUND</b>	<b>37</b>
3.1	KHARMAGTAI PROJECT	38
3.1.1	Location, Access and Physiography	38
3.1.2	Exploration and mining tenure	38
3.1.3	Project Ownership	38
3.1.4	Geology	39
3.1.5	Exploration History	41
3.1.6	Copper Equivalent Grade	42
3.1.7	Kharmagtai Project Mineral Resources	42
3.2	RED MOUNTAIN PROJECT	44
3.2.1	Location, access and physiography	44
3.2.2	Ownership	44
3.2.3	Tenements	44
3.2.4	Exploration History	44
3.2.5	Geology and Mineralisation	46

For personal use only

3.3	SANT TOLGOI PROJECT	46
3.3.1	Location	46
3.3.2	Project Ownership	46
3.3.3	Tenements	47
3.3.4	Exploration History	47
3.3.5	Geology and Mineralisation	48
<b>4.</b>	<b>MINING: KHAMRAGTAI PROJECT</b>	<b>50</b>
4.1	REVIEW SCOPE	50
4.2	DOCUMENTS AND DATA PROVIDED FOR REVIEW	50
4.3	ORE RESERVES	51
4.3.1	Ore Reserve Estimate	51
4.3.2	Mineral Resource Estimate Exclusive of Ore Reserves	53
4.4	MINING STUDY KEY FINDINGS	53
4.4.1	Mining Approach	55
<b>5.</b>	<b>ORE PROCESSING AND BENEFICIATION—KHARMAGTAI PROJECT</b>	<b>63</b>
5.1	OVERVIEW	63
5.1.1	Metallurgical Testing Overview - Sulphide	63
5.1.2	Comminution testing	64
5.1.3	Flotation Testing	65
5.1.4	Flotation Variability	66
5.1.5	Mineralogy	67
5.1.6	Coarse Ore flotation	68
5.1.7	Jameson Testwork	68
5.1.8	Gravity testwork	68
5.1.9	Filtration and Thickening testing	68
5.1.10	Conclusions and Discussion	68
5.2	METALLURGICAL TESTWORK—OXIDE ORE/LEACHING SULPHIDE TAILINGS	69
5.3	PROCESSING	69
5.3.1	PFS Study Design	69
5.3.2	CIL Operation	71
5.3.3	OPEX—FLOTATION CONCENTRATOR	71
5.3.4	Labour	72
5.3.5	Power	72
5.3.6	Reagents and consumables	72
5.3.7	Maintenance Materials	73
5.3.8	Miscellaneous	73
5.4	SMELTING AND REFINING COSTS	74
<b>6.</b>	<b>PROJECT FINANCIAL MODEL REVIEW</b>	<b>75</b>
6.1	FINANCIAL MODEL INPUTS	75
6.1.1	Financial Models	75
6.1.2	CapITAL EXPENDITURE	75
6.1.3	Processing Capital Expenditure	76
6.1.4	Operating Costs	77
6.1.5	Financial Model Metallurgical Inputs	77
6.1.6	Processing pLant Capital and Operating cost Discrepancies Between Financial Models and PFS Report	80
6.1.7	Royalties	80
6.1.8	TAXATION	80

For personal use only

<b>7.</b>	<b>IMPROVEMENT OPPORTUNITIES</b>	<b>83</b>
<b>8.</b>	<b>PROJECT VALUATION DISCUSSION</b>	<b>85</b>
8.1	OVERVIEW	85
8.2	MARKET CAPITALISATION	85
8.3	PROJECT EQUITY	85
8.4	COMPARABLE TRANSACTIONS	86
8.5	VALUATION OPINION: KHARMAGTAI DEPOSIT	94
8.5.1	Income-Based Valuation	94
8.5.2	Mineral Resources Exclusive of Ore Reserves	94
8.5.3	Analysis of Comparable Transactions	95
8.5.4	Rule of Thumb Valuation Opinion	96
8.5.5	PROSPECTIVITY ENHANCEMENT MULTIPLIER	96
8.6	VALUATION OPINION: RED MOUNTAIN DEPOSIT	97
8.6.1	Overview	97
8.6.2	Analysis of Comparable Transactions	98
8.6.3	Prospectivity Enhancement Multiplier	98
8.7	VALUATION OPINION—SANT TOLGOI	98
8.7.1	JV Status	98
<b>9.</b>	<b>VALUATION OPINION AND CONCLUSIONS</b>	<b>100</b>
9.1	VALUATION OPINION	100
9.1.1	Comparable Transactions	100
9.1.2	Kharmagtai Project Ore Reserve	101
9.1.3	Kharmagtai Mineral Resource	101
9.1.4	Kharmagtai Valuation Approach	101
9.1.5	Red Mountain	101
9.1.6	Sant Tolgoi	101
9.2	VALUATION OPINION	102
9.3	CONCLUSIONS	103
<b>10.</b>	<b>REFERENCES</b>	<b>104</b>

## LIST OF TABLES

TABLE 2-1:	VALUATION APPROACHES FOR DIFFERENT TYPES OF MINERAL PROPERTIES (VALMIN, 2015)	29
TABLE 2-2:	PEM FACTORS	32
TABLE 2-3:	GEOSCIENTIFIC FACTOR RANKING	33
TABLE 2-4:	DEFINITION OF EXPLORATION STAGES	35
TABLE 2-5:	PROBABILITY OF SUCCESSFULLY PROCEEDING FROM ONE EXPLORATION STAGE TO ANOTHER.	36
TABLE 3-1:	KHARMAGTAI PROJECT MRE (XANADU MINES LTD, 2024D)	43
TABLE 4-1:	KHARMAGTAI PROJECT ORE RESERVE (XANADU MINES LTD, 2024F)	51
TABLE 4-2:	KHARMAGTAI PROJECT ORE RESERVE BY DEPOSIT (XANADU MINES LTD, 2024F)	51
TABLE 4-3:	MINERAL RESOURCES EXCLUSIVE OF ORE RESERVES	54
TABLE 5-1:	FLOTATION TESTING SUMMARY	65
TABLE 5-2:	LOCKED CYCLE TESTING OF DEPOSIT COMPOSITES, PFS TABLE 9-41	66

TABLE 5-3:	ALS TEST WORK FINAL CONCENTRATE CHARACTERISTICS	66
TABLE 5-4:	JAMESON COMPARISON, ALS REPORT A25165	68
TABLE 5-5:	OPEX SUMMARY, PFS 2024 CHAPTER 9 TABLE 9-36	71
TABLE 5-6:	METALLURGY AND PROCESSING LABOUR REQUIREMENTS	72
TABLE 5-7:	MAINTENANCE MATERIALS ESTIMATE STAGE 1, TABLE 9-43	73
TABLE 6-1:	EXAMPLE OF TBX GRADE AND RECOVERY ESTIMATES, PFS METALLURGY CHAPTER TABLE 9-92	78
TABLE 7-1.	KHARMAGTAI PROJECT IMPROVEMENT OPPORTUNITIES	83
TABLE 8-1:	XAM PROJECT EQUITY	86
TABLE 8-2:	COMPARABLE TRANSACTIONS	87
TABLE 8-3:	COMPARABLE TRANSACTIONS ADJUSTED TO 31 DEC 2024	89
TABLE 8-4:	COMPARABLE TRANSACTIONS ADJUSTED TO 31 DEC 2024 AND 100% EQUITY	91
TABLE 8-5:	KHARMAGTAI PROJECT - MINERAL RESOURCES EXCLUSIVE OF ORE RESERVES (ALLOWING 5% DILUTION AND ORE LOSS)	95
TABLE 8-6:	KHARMAGTAI PROJECT EXPLORATION EXPENDITURE 2022-2024 (US\$)	97
TABLE 8-7:	RED MOUNTAIN PROJECT EXPLORATION EXPENDITURE 2022-2024 (US\$)	98
TABLE 9-1:	XAM MONGOLIAN PROJECTS VALUATION OPINION	102

## LIST OF FIGURES

FIGURE 3-1:	XANADU PROJECT LOCATIONS (XANADU MINES LTD, 2024E)	37
FIGURE 3-2:	KHARMAGTAI MINING LICENCE COVERAGE OF THE DEPOSIT. SOURCE: XANADU MINES	39
FIGURE 3-3:	PLAN VIEW OF THE KHARMAGTAI DISTRICT.	40
FIGURE 3-4:	OBLIQUE VIEW OF THE KHARMAGTAI DEPOSIT, LOOKING NORTH (XANADU MINES LTD, 2024F)	40
FIGURE 3-5:	RED MOUNTAIN MINING LICENCE BOUNDARY IN RELATION TO PROSPECTS FORMING THE RED MOUNTAIN DEPOSIT (XANADU MINES LTD, 2024B)	45
FIGURE 3-6:	SANT TOLGOI TENURE	47
FIGURE 3-7:	SANT TOLGOI REGIONAL SETTING.	48
FIGURE 3-8:	INTERPRETED GEOLOGY OF SANT TOLGOI PROJECT AREA.	49
FIGURE 3-9:	FIELD AREA COPPER ROCK CHIP RESULTS.	49
FIGURE 4-1:	ANNUAL ORE PRODUCTION BY MINERAL RESOURCE CATEGORY.	53
FIGURE 4-2:	KHARMAGTAI DEPOSIT LONG SECTION SHOWING 2024 OPEN PIT DESIGNS. MINERALISATION AT DEPTH BENEATH AND BETWEEN THE OPEN PITS REPRESENTS UNTESTED POTENTIAL FOR FUTURE UNDERGROUND MINING.	56
FIGURE 4-3:	KHARMAGTAI PROJECT AREA INFRASTRUCTURE (XANADU MINES LTD, 2024E)	56
FIGURE 4-4:	KHARMAGTAI PROPOSED SITE LAYOUT.	58
FIGURE 4-5:	KHARMAGTAI PROJECT OVERVIEW LOOKING NORTH (XANADU MINES LTD, 2024E)	58
FIGURE 4-6:	ANNUAL PRODUCTION SCHEDULE (PROBABLE ORE RESERVES PLUS INFERRED MINERAL RESOURCES)	59
FIGURE 4-7:	ANNUAL PRODUCTION SCHEDULE BASED ON PROBABLE ORE RESERVES ONLY.	59
FIGURE 4-8:	MOVEMENT OF ORE TO AND FROM STOCKPILES—PROBABLE ORE RESERVES AND INFERRED MINERAL RESOURCES MODEL.	60
FIGURE 4-9:	MOVEMENT OF ORE TO AND FROM STOCKPILES—PROBABLE ORE RESERVES ONLY MODEL.	61
FIGURE 5-1:	METALLURGICAL TEST WORKFLOW SHEET.	64
FIGURE 5-2:	FINAL CONCENTRATE GRADE VS HEAD S:CU RATIO, ALS REPORT A25165	67
FIGURE 5-3:	STAGE 1 AND 2 PROCESS FLOW SHEET. 2024 PFS, CHAPTER 9, PG12. STAGE 2 (BLUE)	70
FIGURE 6-1:	ORE SCHEDULE DERIVED FROM PROJECT PFS FINANCIAL MODEL	79

FIGURE 6-2: TAX RATES FOR COPPER PROJECTS IN SELECTED COUNTRIES	82
FIGURE 6-3: EFFECT OF TAX RATE ON THE DISTRIBUTION OF WEALTH FOR GLOBAL COPPER PROJECTS 1995-2019	82
FIGURE 8-1: LME COPPER PRICE 25 FEB 2024—24 FEB 2025	85
FIGURE 8-2: XAM SHARE PRICE HISTORY FOR THE 12 MONTHS TO 25 FEBRUARY 2025	86

## ACRONYMS AND ABBREVIATIONS

Abbreviation / Acronym	Description
AIG	Australian Institute of Geoscientists
AusIMM	Australasian Institute of Mining and Metallurgy
ASX	Australian Securities Exchange Ltd
BAC	Base Acquisition Cost—financial basis of the GFM valuation approach
bcm	Bank cubic metres (material as it lies in its natural bank state)
BDO	BDO Corporate Finance Ltd
CAGR	Compound annual growth rate
CIL	Carbon-in-leach
CuEq	Copper Equivalent
DCF	Discounted Cash Flow
EEA	Exploration Expenditure Approach (appraised value mineral asset valuation method for projects without Mineral Resources and Ore Reserves)
ERM	ERM Australia Consultants Pty Ltd
GFM	Geoscience Factor Method (mineral asset valuation method for projects without Mineral Resources and Ore Reserves)
HME	Heavy mining equipment
IER	Independent Expert's Report
IMMI	Ivanhoe Mines Mongolia
IMVAL	International Mineral Valuation Committee
IP	Induced Polarisation
IRR	Internal rate of return
ITSR	Independent Technical Specialist's report
JICA	Japan International Cooperation Agency
JORC	Australasian Code for Reporting of Exploration Results, Mineral Resources and Ore Reserves (The JORC Code, 2012 edition)
JV	Joint venture
KGR	Kilburn Geoscience Rating (synonymous with GFM)

For personal use only

Abbreviation / Acronym	Description
KIC	Kharmagtai Igneous Complex
km <sup>2</sup>	square kilometre
koz	Thousand (Troy) ounces
LME	London Metals Exchange
LOM	Life of Mine
MEE	Multiple of Exploration Expenditure
ML	Mining Licence/Mining Lease
MMAJ	Metal Mining Agency of Japan
MMP	Mine management plan
Moz	Million (Troy) ounces
MRE	Mineral Resource Estimate
Mt	Million tonnes
Mtpa	Million tonnes per annum
NPV	Net Present Value
OPEX	Operating expenditure
PEM	Prospectivity Enhancement Multiplier, component of EEA valuations
PFS	Prefeasibility Study
RMIC	Red Mountain Intrusive Complex
ROM	Run of Mine
RPGeo	Registered Professional Geoscientist
RC	Reverse circulation (non-cored) drilling
SAG	Semiautogenous grinding
SGC	Spiers Geological Consultants
STSM	STSM LLC
TMC	Temujin Mining Corp
TMI	Total magnetic intensity (geophysical survey)
tpa	tonnes per annum (mining, production rate)
TSX	Toronto Stock Exchange
TTRC	True Technological Research Centre (metallurgical research and testing laboratory in Mongolia)
USGS	United States Geological Survey

For personal use only

Abbreviation / Acronym	Description
VALMIN	Australasian Code for Public Reporting of Technical Assessments and Valuations of Mineral Assets (The VALMIN Code 2015 edition)
WRD	Waste rock dump(s)
wt%	Weight per cent
XAM	Xanadu Mines Ltd

For personal use only

# 1. INTRODUCTION

## 1.1 SCOPE OF WORK

Xanadu Mines Ltd (XAM, "the Company") is an Australian Securities Exchange (ASX) listed exploration company focused on discovery and definition of porphyry copper-gold deposits in Mongolia. The Company maintains a multistage portfolio of exploration projects.

The Company's three projects comprise one advanced (Kharmagtai) and two earlier stage exploration opportunities (Red Mountain and Sant Tolgoi) in Mongolia. Kharmagtai and Red Mountain are located in South Gobi province. Sant Tolgoi is located in northwestern Mongolia in Zavchan Province close to Mongolia's border with Russia.

BDO Corporate Finance Ltd (BDO) has been engaged by XAM to prepare an IER for inclusion within a Notice of Meeting to be provided to the shareholders of the Company. The Notice of Meeting is to provide shareholders with the information they require to make an informed decision on a proposed transaction. This transaction is the execution of an option that would result in the sale of half its share in the Kharmagtai project to Zijin Mining Group Ltd ('Proposed Transaction'). The BDO IER is required to provide an opinion on whether the proposed transaction is fair and reasonable to non-associated shareholders.

BDO has in turn requested that ERM prepare an Independent Technical Specialists' Report (ITR) for the three projects meeting the requirements of the VALMIN Code (2015). ERM will be supporting BDO Corporate Finance (BDO) who require ERM's opinion of the value of the projects, and of parameters used in a financial model for the Kharmagtai project.

BDO required a review of the technical project assumptions of the Kharmagtai project, to provide BDO with an assessment on the reasonableness of each of the assumptions used in the cash flow model ('Model'), including the:

1. Mineral Resources and Ore Reserves incorporated into the Model, and the treatment of any residual
2. mining physicals (including tonnes of ore mined, quality, waste material and mine life)
3. processing physicals (including ore processed and produced)
4. production and operating costs (including but not limited to drilling, blasting, mining, haulage, processing, transport, general administration, distribution and marketing, contingencies and royalties or levies)
5. CAPEX (including but not limited to pre-production costs, project capital costs, sustaining CAPEX, salvage value, rehabilitation and contingency)
6. any other relevant technical assumptions not specified above

In addition, ERM will provide BDO with ERM's independent opinion on the value of the value of the Red Mountain and Sant Tolgoi exploration projects.

Exploration project valuations and Mineral Resources excluded from Ore Reserves will be valued using more than one technique to provide a level of confidence in the valuation opinions.

Xanadu is liable for payment for ERM's work.

For personal use only



The Report, or a summary of it, is to be appended to the IER, and as such, will become a public document.

## 1.2 EFFECTIVE DATE

The effective date of this report is 25<sup>th</sup> February 2025. The report uses information provided to ERM by XAM through access to a project data room, in addition to information obtained by ERM from other sources.

## 1.3 APPROACH

This Independent Technical Assessment is the product of a desktop study.

The valuation of the projects was based on several methodologies including:

- recent comparable transactions
- multiples of previous exploration and resource evaluation expenditure
- Geoscience Factor Method (Kilburn Geoscience Rating) valuation
- Rule of Thumb (Yardstick) valuation and
- a critical review of geological and mining input parameters proposed for use by BDO in preparing an income-based valuation for the project.

An income-based valuation of the project will be presented by BDO in the IER. ERM has examined and validated inputs to the Kharmagtai project's financial model and prepared a valuation opinion of Mineral Resources not included in the project's Ore Reserve. ERM has also prepared an exploration asset valuation for the Red Mountain and Sant Tolgoi projects.

Two financial models were prepared during the project's PFS, based on production schedules that:

1. include both Ore Reserves and Inferred Mineral Resources that occur proximal to Ore Reserves and occur within open pit designs developed for the Kharmagtai deposit; and
2. are based on Ore Reserves only.

ERM's view is that the latter should be used in an income-based valuation of the project. Confidence in Inferred Resource estimates is insufficient for this mineralisation to be valued in conjunction with Ore Reserves, by definition, according to the JORC Code (JORC, 2012). Inferred Mineral Resources are able, however, to be ascribed value using market and cost, rather than income-based valuation approaches.

## 1.4 COMPLIANCE WITH THE JORC AND VALMIN CODES

This report has been prepared to meet all the requirements of the VALMIN and JORC Codes for mineral asset valuation (VALMIN, 2015) and public reporting of Exploration Results, Mineral Resources and Ore Reserves (JORC, 2012) respectively.

## 1.5 PRINCIPAL SOURCES OF INFORMATION

Information required to complete this work was sourced from reports and other information made available by XAM, and other publicly accessible sources identified by ERM documented in the Report.

For personal use only

## 1.6 SITE VISIT

Site visits were not conducted in the course of preparing this report due to logistical issues with accessing the three exploration sites during the winter in Mongolia. The limited information that would be obtained by visiting exploration sites with no current activity was also not considered likely to be material to the outcomes of this report.

## 1.7 COMMODITY PRICES

Commodity prices used by this study are based on the February 2025 forecasts published by Consensus Economics Inc. (Consensus) (Consensus Economics, 2025).

The Consensus Economics February 2025 survey reported a spot copper price of US\$9,291 per tonne. Forecast prices between March 2025 and December 2026 ranged from US\$9,201 and US\$9,590 per tonne.

The copper price is predicted by Consensus Economics survey data to remain above US\$9000 per tonne which would trigger the application of the maximum copper royalty rates specified in the Minerals Law of Mongolia, were the rate not to be adjusted by negotiation for individual projects.

The 17 February 2025 Consensus Economics survey reported a gold spot price of \$US2,901 per ounce. Forecast gold prices between March 2025 and December 2026 published in the February 2025 survey report ranged from US\$2,681 to US\$2,767 per ounce.

## 1.8 EXCHANGE RATES

Exchange Rates used in this report are rates published by the Reserve Bank of Australia effective 25<sup>th</sup> February 2025. The US\$:A\$ Exchange Rate at 25<sup>th</sup> February 2025 was 0.6351.

## 1.9 REPORT AUTHORS -QUALIFICATIONS, EXPERIENCE AND COMPETENCE

### 1.9.1 REPORT AUTHORS

#### **Max Nind**

MSc (Geology), BSc (Geology and Geography), GradDipFinInv, MAIG

#### **Principal Consultant, Geology**

Max Nind is an experienced geologist with over 35 years' experience working in exploration, mine geology, financial evaluation and corporate management of assets in Australia, USA, New Zealand and Canada. He has led multidisciplinary study and exploration teams globally in the search for base metals, gold, bulk commodities, cobalt, and industrial minerals (clay and quartz). Max gained a solid foundation in mining during working underground, managing geological departments of various mines. His extensive corporate and financial experience ranges from leading corporate management and project study teams; developing and maintaining strong working relations with stakeholders; leading commercial negotiations with contractors, government agencies and financial institutions; to identifying, assessing and developing business investment opportunities. Max's strong business acumen, combined with a deep understanding of project fundamentals, allows him to provide strategic advice to resource clients.

**Khairulla Aben**

PhD, MAusIMM CP(Min), MPONEN

**Principal Consultant - Mining Engineering**

Khairulla is an experienced mining professional who has delivered mining engineering, mine planning and economic evaluation for projects, technical studies and operations. He has delivered open pit and underground projects and studies across multiple commodities, with responsibilities for design, planning, scheduling of mine operations and economic evaluation. Khairulla has focused on preparing mining studies, due diligence and expert opinion reports. He complements these capabilities through the advanced application of modern mining software systems, the implementation of technologies and the application of best practices.

Experience in projects around the world with wide experience in Kazakhstan, Australia, Kyrgyzstan and Russia.

**Robert Kochmanski**

BE-(Metal), FIEAust CPEng NER APEC Engineer IntPE(Aus)) P.Eng (Alberta)

**Senior Process Engineer (Associate, BHM Process Consultants)**

Robert Kochmanski is a Senior Process Engineer who has performed a variety of operational, commissioning and study roles since graduating in 2007. Rob has worked in a wide variety of minerals including gold, base metals, iron ore and industrial minerals. In addition, he has had wide exposure to many unit processes including (but not limited to) comminution, froth flotation, leaching, gravity separation, magnetic separation, filtering thickening, ore sorting, solvent extraction and electrowinning and complex hydrometallurgy. The operational roles have been mostly on newly established processing plants in their commissioning or ramp-up stages. As such there has been a significant focus on developing systems and operational support with operator training. Project Development work has been focused from scoping studies to definitive feasibility studies with technical and preliminary engineering input being given to develop projects.

**Andrew Waltho**

BAppSc (Hons) FAIG RPGeo (MinExpl, Mining), FAusIMM, FGS, Professional Member SME, GAICD

**Consulting Director, Mining Transaction and Corporate Advisory, ERM Mining Technical Services**

Andrew has more than 40 years as an exploration and mining geoscientist spanning multiple commodities, deposit styles and settings with major, mid-tier and junior companies and as a consultant. Andrew also has more than 23 years' experience as a director of resources sector companies and not for profit professional organisations. He is a past-President of the Australian Institute of Geoscientists and Chair of the Institute's Ethics and Standards Committee. Andrew was recently appointed to the VALMIN Committee which is responsible for the development of the Australasian Code for Public Reporting of Technical Assessments and Valuations of Mineral Assets. He is also an Australian representative on the International Mineral Valuation Committee (IMVAL) that promotes consistency of mineral asset valuation practices globally.

Andrew has more than 40 years of experience in exploration, resource evaluation and due diligence for a range of commodities including phosphates in Australia and overseas. Other

For personal use only

career highlights have included deep involvement in the development of the Century zinc-lead-silver mine in northwest Queensland, extending from early exploration through all stages of feasibility to commissioning and the initial years of production. Other highlights have included participation in feasibility studies for the Dugald River zinc project in Queensland, the Jadar lithium-borate project in Serbia and due diligence reviews for multiple projects spanning a broad suite of commodities, including gold, base metals, uranium, potash, phosphates, industrial minerals and mineral sands, again both in Australia and overseas.

### **Graham Jeffress**

BSc (Hons) Geology, MAIG, MAusIMM

### **Partner, Operations Director ERM Mining Technical Services, Principal Geologist**

Graham is a geologist with over 35 years' experience in exploration geology and management in Australia, PNG and Indonesia. He is a Principal Geologist and the Service Lead for the Sustainable Mining Services in Australia. He has worked in exploration (ranging from grassroots reconnaissance through to brownfields, near-mine, and resource definition), project evaluation and mining in a variety of geological terrains, commodities and mineralisation styles within Australia and internationally. He is competent in multidisciplinary exploration, and proficient at undertaking prospect evaluation and all phases of exploration. Graham has completed numerous independent technical reports (IGR, CPR, QPR) and valuations of mineral assets. Graham capitalised on his knowledge of exploration to undertake expert technical reviews, valuations and independent reporting services to groups desiring improved understanding of the value, risks and opportunities associated with mineral investment opportunities. Graham was a Federal Councillor/board member (including Company Secretary and Treasurer) of the Australian Institute of Geoscientists for 11 years and joined the Joint Ore Reserves Committee in 2014, where he is currently a member of the executive committee. As the Service Lead for the Sustainable Mining Services team in Australia he is now responsible for managing geoscience and mining engineering in the Australasian region.

### **1.9.2 REPORT AUTHOR RESPONSIBILITIES**

Max Nind is primarily responsible for the descriptions of project locations, physiography, climate, access to infrastructure, geology and exploration potential for each of XAM's three projects in Mongolia: Kharmagtai, Red Mountain and Sant Tolgoi; examined in this report.

Khairulla Aben undertook review of the Kharmagtai mining strategy and development plan, project infrastructure requirements and development costs associated with the project. This included a detailed review of mining capital and operating expenditure and mining related inputs to the Kharmagtai financial model.

Rob Kochmanski reviewed the metallurgical testwork, and metallurgical concentrate production options for different ore types present in the deposit. Mr Kochmanski also reviewed the metallurgical process and plant design, capital and operating costs for these facilities.

Andrew Waltho examined the assessment of geotechnical and water supply options for the project and reviewed the report to ensure consistency of information used in each aspect of the overall assessment.

Graham Jeffress managed ERM's internal peer review of the draft report and authorised release of a final draft for BDO and XAM review, prior to finalising the study.

## 1.10 PRIOR ASSOCIATION AND INDEPENDENCE

This report's authors and reviewers have no previous association with XAM. Neither ERM nor the authors and reviewer of this report, have or have had previously, any material interest in XAM or the Company's operations and exploration projects that form the subjects of this report.

ERM's relationship with XAM is solely one of professional association between client and independent consultant. This report is prepared in return for professional fees based upon agreed commercial rates and the payment of these fees is in no way contingent on the results of this report. ERM's fee for the preparation of this report is approximately A\$71,550, excluding Australian goods and services tax (GST), including contingency.

No employee of ERM is, or is intended to become, a director, officer or other direct employee of XAM. There is no formal agreement between ERM and XAM in relation to ERM conducting further work for the company.

## 1.11 DISCLAIMERS

The statements and opinions contained in this report are given in good faith and in the belief that they are not false nor misleading. The report is based on information available up to and including the date of this report.

The statements and opinions are based on a reference date of 29 November 2024 and could alter over time depending on exploration results, mineral resource knowledge, mineral prices and other relevant market factors.

The opinions expressed in the report have been based on information compiled by ERM. The opinions in the report are provided in response to a specific request from XAM to do so. ERM has exercised all due care in reviewing the supplied information. While ERM has compared key supplied data with expected values, the accuracy of the results and conclusions from the review are entirely reliant on the accuracy and completeness of the data assembled by ERM for this report. ERM does not accept responsibility for any errors or omissions in the information and does not accept any consequential liability arising from commercial decisions or actions resulting from them.

ERM's valuation opinions are based on both public and non-public information. The information available is the product reasonable enquiries within the time available, to confirm the authenticity and completeness of the technical data and other relevant information used.

ERM considers that its opinion must be considered as a whole and that selecting portions of the analysis, or factors considered by it, without considering all factors and analyses together could create a misleading view of the process underlying the opinions presented in this report. The timing and context of an independent valuation report is complex and does not lend itself to partial analysis or selective interpretations without consideration of the entire report.

No audit of any financial data has been conducted.

The valuations discussed in the report are opinions as to likely values, not absolute values, which can only be tested by going to the market.

For personal use only



## 1.12 CONSENT

ERM gives consent to BDO to use the report for the purposes stated within the scope. The Report is not to be used for purposes outside of these scope without ERM's written consent.

For personal use only



## 2. MINERAL ASSET VALUATION PRINCIPLES

### 2.1 BASIC PRINCIPLES

Valuation of mineral assets is not an exact science, and several approaches are possible, each with varying strengths and shortcomings. While valuation is a subjective exercise, there are several generally accepted methods for ascertaining the value of mineral assets. ERM considers that, wherever possible, inputs from a range of methods should be assessed to inform conclusions about the Market Value of Mineral Assets.

A valuation opinion should always be presented as a range, with the preferred value identified. The preferred value need not be the median value and is determined by the Practitioner based on their experience and professional judgement.

Mineral Assets are defined in the VALMIN Code (VALMIN, 2015) as all property including (but not limited to) tangible property, intellectual property, mining and exploration tenure and other rights held or acquired in connection with the exploration, development of and production from those Tenures. This may include the plant, equipment and infrastructure owned or acquired for the development, extraction and processing of minerals in connection with that tenure.

Business valuers typically define market value as "The price that would be negotiated in an open and unrestricted market between a knowledgeable, willing, but not anxious buyer and a knowledgeable, willing but not anxious seller acting at arms-length." The accounting criterion for a market valuation is that it is an assessment of "fair value," which is defined in the accounting standards as "the amount for which an asset could be exchanged between knowledgeable, willing parties in an arms-length transaction." The VALMIN Code defines the value of a mineral asset as its market value, which is "the estimated amount (or the cash equivalent of some other consideration) for which the mineral asset should exchange on the date of valuation between a willing buyer and a willing seller in an arms-length transaction after appropriate marketing where the parties had each acted knowledgeably, prudently and without compulsion."

Market Value usually consists of two components, the underlying or technical value, and a premium or discount relating to market, strategic or other considerations. The VALMIN Code recommends that a preferred or most likely value be selected as the most likely figure within a range after considering those factors which might impact on value.

The concept of market value hinges upon the notion of an asset changing hands in an arms-length transaction. Market Value must therefore consider, inter alia, market considerations, which can only be determined by reference to "comparable transactions." Generally, truly comparable transactions for mineral assets are difficult to identify due to the infrequency of transactions involving producing assets and/or Mineral Resources, the great diversity of mineral exploration properties, the stage to which their evaluation has progressed, perceptions of prospectivity, tenement types, the commodity involved and so on.

For exploration tenements, the notion of value is very often based on considerations unrelated to the amount of cash which might change hands in the event of an outright sale, and in fact, for the majority of tenements being valued, there is unlikely to be any "cash equivalent of some other consideration." While acknowledging these limitations, ERM identifies what it considers to be "comparable transactions" (i.e. transactions that are useful to consider) to be used in assessing the values to be attributed to mineral assets.

For personal use only

## 2.2 VALUATION METHODS FOR MINERAL ASSETS

The choice of valuation methodology applied to mineral assets, including exploration licences, depends on the amount of data available and the reliability of that data.

The VALMIN Code classifies mineral assets into categories that represent a spectrum from areas in which mineralisation may or may not have been found through to operating mines which have well-defined Ore Reserves, as listed below:

**“Early-stage exploration projects”** – tenure holdings where mineralisation may or may not have been identified, but where Mineral Resources have not been identified.

**“Advanced exploration projects”** – tenure holdings where considerable exploration has been undertaken and specific targets identified that warrant further detailed evaluation, usually by drill testing, trenching or some other form of detailed geological sampling. A Mineral Resource (as defined in the JORC Code) estimate may or may not have been made but sufficient work will have been undertaken on at least one prospect to provide both a good understanding of the type of mineralisation present and encouragement that further work will elevate one or more of the prospects to the Mineral Resources category.

**“Pre-Development projects”** – tenure holdings where Mineral Resources have been identified and their extent estimated (possibly incompletely) but where a decision to proceed with development has not been made. Properties at the early assessment stage, properties for which a decision has been made not to proceed with development, properties on care and maintenance and properties held on retention titles are included in this category if Mineral Resources have been identified, even if no further work is being undertaken.

**“Development projects”** – tenure holdings for which a decision has been made to proceed with construction or production or both, but which are not yet commissioned or operating at design levels. Economic viability of development projects will be proven by at least a PFS.

**“Production projects”** – tenure holdings (particularly mines, wellfields and processing plants) that have been commissioned and are in production.

Each of these different categories will require different valuation methodologies, but regardless of the technique employed, consideration must be given to the perceived “market valuation.”

The Market Value of Exploration Properties and Undeveloped Mineral Resources can be determined by the following general approaches: Income, Market and Cost (Table 2-1). The Market Value of Development and Production Projects are best assessed using the Market and Income approaches, whereas the market value of exploration projects is best assessed using the Market and Cost approaches.

## 2.3 VALUATION APPROACHES BY ASSET STAGE

Regardless of the technical application of various valuation methods and guidelines, the valuer should strive to adequately reflect the carefully considered risks and potentials of the various projects in the valuation ranges and the preferred values, with the overriding objective of determining the “fair market value”.

Table 2-1 shows the valuation approaches that are generally considered appropriate to apply to each type of mineral property.

For personal use only



Table 2-1: Valuation approaches for different types of mineral properties (VALMIN, 2015)

Valuation Approach	Exploration Properties	Mineral Resource Properties	Development Properties	Production Properties
Income	No	In some cases	Yes	Yes
Market	Yes	Yes	Yes	Yes
Cost	Yes	In some cases	No	No

## 2.4 INCOME

### 2.4.1 DISCOUNTED CASH FLOW/NET PRESENT VALUE METHOD

The Discounted Cash Flow (DCF) valuation method recognises the time value of money, it is most suitable for development projects, where detailed studies have been completed to justify input assumptions and Production Projects, where there is actual historical data to justify input assumptions. Less commonly the DCF methodology is applied to pre-development projects.

The DCF valuation method provides a means of relating the magnitude of expected future cash profits to the magnitude of the initial cash investment required to purchase a mineral asset or to develop it for commercial production.

The DCF valuation method determines:

- The net present value (NPV) of a stream of expected future cash revenues and costs.
- The internal rate of return (IRR) that the expected cash flows will yield on a given cash investment.

The DCF valuation method is a forward-looking methodology, requiring that forecasts be made of technical and economic conditions which will prevail in the future. All future predictions are inherently uncertain. The level of uncertainty reduces as the quality of the data available to project future rates of production and future costs, increases.

It is essential to understand specific fundamental attributes of the mining industry in undertaking a DCF, such as:

- An Ore Reserve and in some cases Mineral Resource is the basis of any mineral development.
- Costs are determined by the number of tonnes mined and processed, while revenues are determined by the number of tonnes, pounds or ounces of metal produced. The two are related by the recovered grade of the ore.
- Profit is typically more sensitive to changes in revenue than to changes in costs.
- The commodity price is a principal determinant of revenue but is also the factor with the greatest level of financial risk.

The most significant factors, which must be considered in a DCF valuation of a mineral asset is the reliability of the Mineral Resource and Ore Reserve, particularly with respect to recovered grade, the price at which the product is sold and the risk of not maintaining the projected level of commodity price.

Key inputs into the DCF valuation method for a mineral asset valuation are:

- life of mine planning assumptions
- capital cost estimates—can be the initial cost of constructing the project and/or the ongoing cost of sustaining the productive life of the operation
- operating cost estimates—costs incurred both on-site in producing the commodity which is shipped from the property, and off site, in the transportation and downstream processing of that commodity into saleable end products
- revenue estimates—revenue in the mining context is the product of the following factors:
  - the tonnage of ore mined and processed
  - the grade of the ore
  - the metallurgical recovery
  - the price of the saleable commodity
  - taxation and royalty payments
  - discount rate—represents the risk adjusted rate of interest expected to be yielded by an investment in the mineral asset

The Income Approach is not appropriate for properties without Mineral Resources. It should be employed only where enough reliable data are available to provide realistic inputs to a financial model, preferably based on studies at or exceeding a prefeasibility level.

## 2.5 MARKET

### 2.5.1 COMPARABLE TRANSACTION METHOD

The comparable transactions method looks at prior transactions for the property and recent arms-length transactions for comparable properties.

The comparable transaction method provides a useful guide where a mineral asset that is generally comparable in location and commodity has in the recent past been the subject of an “arms-length” transaction, for either cash or shares.

For the market approach resources are not generally subdivided into their constituent JORC Code categories. The total endowment or consolidated *in situ* resources are what drives the derivation of value. Each transaction implicitly captures the specific permutation of resource categories in a project. There are too many project-specific factors at play to allow any more than a consideration of price paid vs total resource base. Therefore, considering individual project resource permutations is neither practicable nor useful for this valuation approach. To that end ERM’s discussion of the market approach is predicated on the consolidated resource base, to allow application of the method.

Where a progressively increasing interest is to be earned in stages, it is likely that a commitment to the second or subsequent stages of expenditure will be so heavily contingent upon the results achieved during the earlier phases of exploration that assigning a probability to the subsequent stages proceeding will in most cases be meaningless. A commitment to a minimum level of expenditure before an incoming party can withdraw must reflect that party’s perception of minimum value and should not be discounted. Similarly, any up-front cash payments should not be discounted.

The terms of a sale or JV agreement should reflect the agreed value of the tenements at the time, irrespective of transactions or historical exploration expenditure prior to that date. Hence the current value of a tenement or tenements will be the value implied from the terms of the most recent transaction involving it/them, plus any change in value as a result of subsequent exploration.

High quality mineral assets are likely to trade at a premium over the general market. On the other hand, exploration tenements that have no defined attributes apart from interesting geology or a "good address" may well trade at a discount to the general market. Market Values for exploration tenements may also be impacted by the size of the land holding, with a large, consolidated holding in an area with good exploration potential attracting a premium due to its appeal to large companies.

### 2.5.2 RULE OF THUMB (YARDSTICK)

The Rule of Thumb (Yardstick) method is relevant to exploration properties where some data on tonnage and grade exist, and these properties may be valued by methods that employ the concept of an arbitrarily ascribed current in-situ net value to any Ore Reserves (or Mineral Resources) outlined within the tenement (Lawrence, An Outline of Market-based Approaches for Mineral Asset Valuation Best Practice, 2001), (Lawrence, 2011).

Rules-of-Thumb (Yardstick) methods are commonly used where a Mineral Resource remains in the Inferred category and available technical/economic information is limited. This approach ascribes a heavily discounted in situ value to the resources, based upon a subjective estimate of the future profit or net value (say per tonne of ore) to derive a Rule of Thumb.

This Yardstick multiplier factor applied to the resources delineated (depending upon category) varies depending on the commodity. Typically, a range from 0.4% to 3% of the current spot price is used for base metals and platinum group metals, whereas for gold and diamonds a range of 2% to 5% of the current spot price is used, and typically much lower factors are applied for bulk commodities. The method estimates the in situ gross metal content value of the mineralisation delineated (using the spot metal price and appropriate metal equivalents for polymetallic mineralisation as at the valuation date).

The chosen percentage is based upon the valuer's risk assessment of the assigned Mineral Resource category, the commodity's likely extraction and treatment costs, availability / proximity of transport and other infrastructure (particularly a suitable processing facility), physiography and maturity of the mineral field, as well as the depth and strip ratio of the potential mining operation.

This method is best used as a non-corroborative check on the order of magnitude of values derived using other valuation methods that are likely to better reflect project-specific criteria.

## 2.6 COST

### 2.6.1 APPRAISED VALUE OR EXPLORATION EXPENDITURE APPROACH

The Appraised Value or Exploration Expenditure Approach (EEA) considers the costs and results of historical exploration.

The Appraised Value method is based on the premise that the real value of an exploration property lies in its potential for the existence and discovery of an economic mineral deposit

(Roscoe, 2002). It utilises a Multiple of Exploration Expenditure (MEE), which involves the allocation of a premium or discount to past relevant and effective expenditure using the PEM. This involves a factor which is directly related to the success (or failure) of the exploration completed to date, during the life of the current tenements.

Guidelines for the selection of a PEM factor have been proposed by several authors in the field of mineral asset valuation (Onley, 2004). Table 2-2 lists the PEM factors and criteria used in this report.

Table 2-2: PEM Factors

PEM range	Criteria
0.2 to 0.5	Exploration (past and present) has downgraded the tenement prospectivity, no mineralisation identified
0.5 to 1.0	Exploration potential has been maintained (rather than enhanced) by past and present activity from regional mapping
1.0 to 1.3	Exploration has maintained, or slightly enhanced (but not downgraded) the prospectivity
1.3 to 1.5	Exploration has considerably increased the prospectivity (geological mapping, geochemical, or geophysical activities)
1.5 to 2.0	Scout drilling (rotary air blast, air-core, RC percussion) has identified interesting intersections of mineralisation
2.0 to 2.5	Detailed drilling has defined targets with potential economic interest
2.5 to 3.0	A Mineral Resource has been estimated at Inferred JORC category, no concept, or scoping study has been completed
3.0 to 4.0	Indicated Mineral Resources have been estimated that are likely to form the basis of a PFS
4.0 to 5.0	Indicated and Measured Resources have been estimated, and economic parameters are available for assessment

## 2.6.2 GEOSCIENCE FACTORS

The Geoscience Factor Method (GFM) or Kilburn Geoscience Rating (KGR), as described by Kilburn (1990), provides an approach for the technical valuation of the exploration potential of mineral properties, on which there are no defined resources. It seeks to rank and weight geological aspects, including proximity to mines, deposits and the significance of the camp and the commodity sought. The criteria originally proposed by Kilburn (Kilburn, 1990) have been modified by several authors since the approach was originally published. The version of the GFM criteria used by ERM incorporate changes advocated by SRK in a previous review of Avenir's mineral assets (McKibben, 2019).

Valuation is based upon a calculation in which the geological prospectivity, commodity markets and mineral property markets are assessed independently. The GFM is essentially a technique to define a value based upon geological prospectivity. The method appraises a variety of mineral property characteristics:

Location with respect to any off-property mineral occurrence of value, or favourable geological, geochemical or geophysical anomalies

Location and nature of any mineralisation, geochemical, geological or geophysical anomaly within the property and the tenor of any mineralisation known to exist on the property being valued.

Number and relative position of anomalies on the property being valued.

Geological models appropriate to the property being valued.

The GFM systematically assesses and grades these four key technical attributes of a tenement to arrive at a series of multiplier factors (Table 2-3).

**Table 2-3: Geoscientific Factor Ranking**

Rating	Address/Off-property factors	On property factors	Anomaly factors	Geological factors
0.1			No mineralisation identified; area sterilised	Unfavourable geological setting, No alteration of interest
0.5		Very little chance of mineralisation; Concept unsuitable to the environment	Extensive previous exploration with poor results	Potentially favourable geological setting but poor results to date, complexly deformed and metamorphosed
1	No known mineralisation in district	Exploration model support; Indications of prospectivity; Concept validated	Extensive previous exploration with encouraging results; Regional targets	Deep cover; Generally favourable lithology/ alteration (70%)
1.5	Reconnaissance (rotary air blast/air-core) drilling with some scattered favourable results. Minor workings	Exploratory sampling with encouragement	Several early-stage targets outlined from geochemistry and geophysics	Shallow cover; Generally favourable lithology/ alteration
2	Several old workings; Significant RC percussion drilling leading to advanced project	Several old workings; Reconnaissance drilling or RC percussion drilling with encouraging intersections	Several well-defined targets supported by reconnaissance drilling data. Multiple exploration models being applied simultaneously	Exposed favourable; Lithology/alteration
2.5	Abundant workings; Grid drilling with encouraging results on adjacent sections	Abundant workings; Core drilling after RC percussion with encouragement	Several well-defined targets with encouraging drilling results	Strongly favourable lithology, alteration
3	Mineral Resource areas defined	Advanced Resource definition drilling (early stages)	Several significant subeconomic targets; No indication of "size"	Generally favourable lithology with structures along strike of a major mine; Very prospective geology
3.5	Abundant workings/mines with significant historical production; Adjacent to	Abundant workings/mines with significant historical production; Mineral Resource areas defined	Several significant subeconomic targets; Potential for significant "size"; Early-stage drilling	

For personal use only

Rating	Address/Off-property factors	On property factors	Anomaly factors	Geological factors
	known mineralisation at PFS stage			
4	Along strike or adjacent to resources at Definitive Feasibility Study stage	Adjacent to known mineralisation at PFS stage	Marginally economic targets of significant "size" advanced drilling	
4.5	Adjacent to development stage project	Along strike or adjacent to resources at Definitive Feasibility Study stage	Marginal economic targets of significant "size" with well drilled Inferred Resources	
5	Along strike from operating major mine(s)	Adjacent to development stage project	Several significant ore grade co-relatable intersections	
6				Advanced exploration model constrained by known and well understood mineralisation
10		World class deposit / mine		

The Geoscience Rating Factor valuation method is a subjective valuation method, and different valuation practitioners are likely to derive different on-off-property, anomaly and geological factors, based on their interpretation and understanding of the project. Different descriptions of the rating factors also exist. However, provided the same rating system of factors and descriptions of their values is used, the results from different practitioners should not be dramatically different.

The Base Acquisition Cost (BAC) is an important input to the GFM. In essence, it is the average cost to acquire and hold an average tenement in the jurisdiction and it is determined by summing the costs to identify an area of interest, application fees, annual rents and other government costs, work required to facilitate granting (e.g. Native Title, environmental etc.) and minimum annual statutory expenditures. In other words, the BAC is the total average expenditure per standard unit area (km<sup>2</sup>, hectare, subblock, etc.) and captures the identification cost and then the application and retention costs. Each factor is then multiplied serially by the BAC to establish the overall technical value of each mineral property. A fifth factor, the market factor, is then multiplied by the technical value to arrive at the fair market value.

The standard references on the method (Kilburn, 1990) (Goulevitch & Eupene, 1994) do not provide much detail on how the market factor should be ascertained. ERM takes the approach of using the implied value range from our selected comparable transactions to inform the selection of a GFM market factor. Our presumption is that the selected comparable transactions are capturing the market sentiment, so any other valuation method should not be significantly different (order of magnitude).

This is achieved by finding the market factor that produces an average GFM preferred value per unit area for whole project (i.e. total preferred GFM value divided by the total area) that falls within the range of the comparable transactions implied values per unit area. It is ERM's view that this adequately accounts for global market factors on an empirical basis. For example, if the implied value range is \$100/km<sup>2</sup> to \$2000/km<sup>2</sup>, then the market factor should give an average GFM preferred value per unit area that falls within that range.

ERM generally would select a market factor (rounded to an appropriate number of significant digits) that gives a value closer to the upper end of the range (though this is the valuer's judgement call). This is because the GFM is a tool that addresses the exploration potential of a project and is best suited to informing the upper end of valuation ranges for a project.

### 2.6.3 GEOLOGICAL RISK METHOD

In the Geological Risk valuation method, as described by Lord, Etheridge, Wilson, Hall, & Uttley (2001), the value of a project at a given stage of knowledge/development is estimated based on the potential value of the project at a later stage of development, discounted by the probability of the potential value of the later stage being achieved, and considering the estimated cost of progressing the project to the next stage. The relevant stages of exploration are defined in Table 2-4.

Table 2-4: Definition of exploration stages

Stage	Description
Stage A	Ground acquisition, project/target generation
Stage B	Prospect definition (mapping and geochemistry)
Stage C	Drill testing (systematic RC, diamond drilling)
Stage D	Resource delineation
Stage E	Feasibility

The expected value (E) of a project at a given stage is then dependent on the target value at the next stage (T), the probability of successfully advancing the project to the next stage (P), and the cost of advancing the project (C). This can be expressed as:

$$E = P * (T - C)$$

This valuation method generates an expected value for each project (or prospect) at each of the main exploration stages or decision points, by working back from a project's target value. A project's target value can be based on an expected NPV from a reasonably constrained DCF model, or from a reasonable approximation of the value of a defined resource, in which case the initial target value will be the value at the end of Stage D, as opposed to the value at the end of Stage E.

Lord, Etheridge, Wilson, Hall, & Uttley (2001) concluded that the probability of successfully proceeding from one exploration phase to the following one was as depicted in

Table 2-5, based on a detailed study of gold exploration programmes in the Laverton area of Western Australia.

The Geological Risk method has not been applied to this study but is described here for completeness.

Table 2-5: Probability of successfully proceeding from one exploration stage to another.

Stages	Probability of advancing
Generative to reconnaissance	0.54
Reconnaissance to systematic drill testing	0.17
Systematic drill testing to Resource delineation	0.58
Resource delineation to Feasibility	0.87
Feasibility to Mine	0.90

Source: (Lord, Etheridge, Wilson, Hall, & Uttley, 2001)

For personal use only



### 3. XANADU MINES BACKGROUND

Xanadu Mines Limited (ASX: XAM) is an exploration company focused on discovery and definition of porphyry copper-gold deposits in Mongolia. The Company maintains a multistage portfolio of exploration projects.

The Company’s three current projects comprise one advanced (Kharmagtai) and two earlier stage exploration opportunities (Red Mountain and Sant Tolgoi) in Mongolia (Figure 3-1). Kharmagtai and Red Mountain are located in South Gobi province. Sant Tolgoi is located in northwestern Mongolia in Zavchan Province close to Mongolia’s border with Russia.

For personal use only

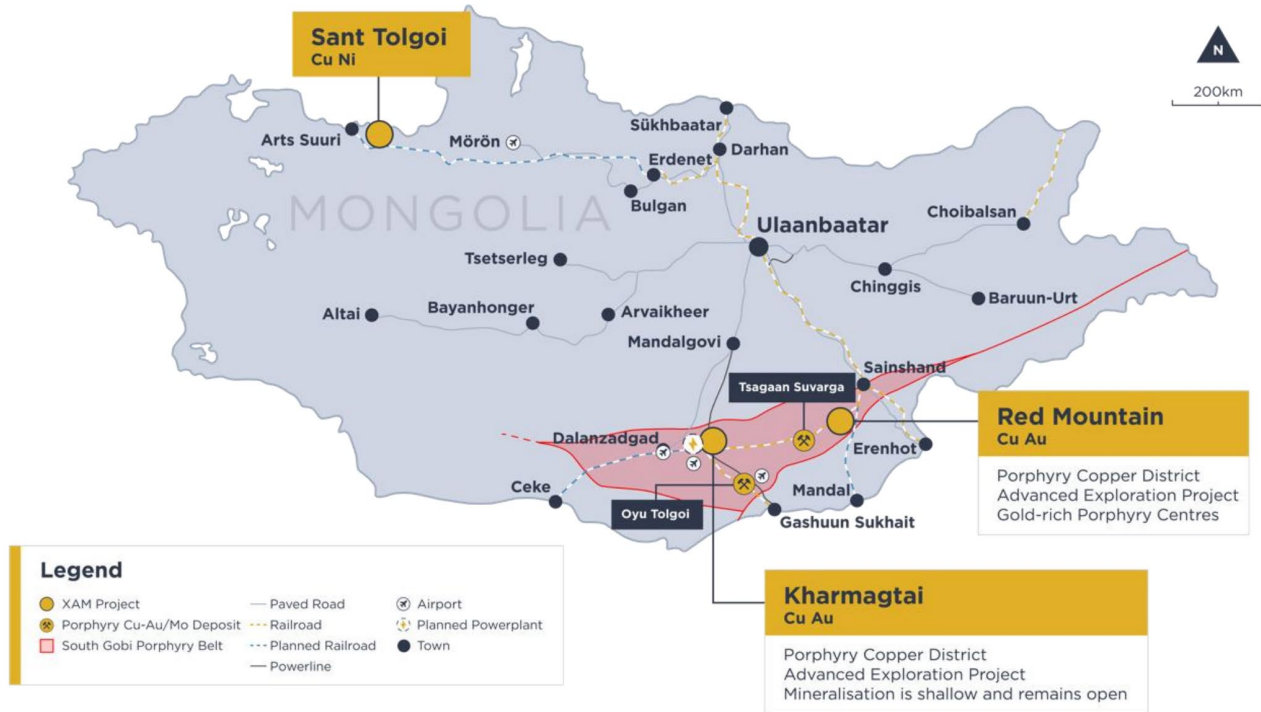

Figure 3-1: Xanadu Project Locations (Xanadu Mines Ltd, 2024e)

The Kharmagtai copper-gold project is located in Omnogovi Province, approximately 420 km southeast of the Mongolian capital, Ulaanbaatar. Xanadu is the Operator of a 50-50 JV with Zijin Mining Group in Khuiten Metals Pte Ltd, which controls 76.5% Kharmagtai. The project is within the South Gobi porphyry copper province which hosts several major porphyry deposits including the Oyu Tolgoi copper-gold operations (120 km south) and Tsagaan Suvarga porphyry copper-molybdenum development (170 km east). Kharmagtai is considered by Xanadu to be the Company’s flagship asset.

The Red Mountain porphyry copper-gold project (100% Xanadu) is located within the Dornogovi Province of southern Mongolia, approximately 420 km southeast of Ulaanbaatar. The porphyry mineralisation at Red Mountain is associated with late-stage monzonite and quartz diorite porphyry dykes and stocks emplaced on the flanks of the RMIC. Alteration and mineralisation at Red Mountain are characterised by multiple co-genetic copper-gold porphyry centres, tourmaline breccia pipes and copper-gold/base metal magnetite skarns. Initial drilling has identified significant, shallow mineralisation spanning four prospects.

The Sant Tolgoi project covers two granted exploration licences, with a combined area of over 40 km<sup>2</sup>, considered by XAM to be highly prospective for new magmatic intrusion-related copper-nickel systems. In early 2024, Xanadu executed a binding agreement with STSM LLC (STSM) granting the right to earn up to an 80% interest in these two exploration licences.

### 3.1 KHARMAGTAI PROJECT

#### 3.1.1 LOCATION, ACCESS AND PHYSIOGRAPHY

Kharmagtai is located within South Gobi (*Omnogovi*) province of Mongolia, approximately 420 km southeast of the capital city Ulaanbaatar (Figure 3-1). The project is accessed via sealed roads from Ulaanbaatar to Tsogt Ovoo and 60 km of unsealed roads from Tsogt Ovoo to Kharmagtai. It requires 6 hours of travel time to reach the project from Ulaanbaatar by road, with the last 1.5 hours on approximately 60 km of unsealed roads.

Topography in the licence area is subdued and characterised by flat gravel covered plains and low undulating hills which range from 1,360 m to 1,250 m above sea level. Vegetation is sparse with low shrubs and grassy plains. The region experiences generally arid continental climatic conditions, varying between +30°C in summer and -30°C in winter.

#### 3.1.2 EXPLORATION AND MINING TENURE

The Kharmagtai deposit is held under Mining Licence MV-017387 granted 27 September 2013 and valid for 30 years (until 27 September 2043). Mining Licence MV-01738 is held by Oyut Ulaan LLC (Oyut Ulaan). Xanadu's interest is secured through a 90% interest in the JV company, Mongol Metals LLC, which in turn holds a 90% interest in Oyut Ulaan.

Coverage of the Kharmagtai deposit by the project's mining licence is shown in Figure 3-2.

ERM was provided with a signed and stamped copy of the mining licence document and accompanying schedule issued by the Mongolian government by XAM. ERM considered the documents provided to be authentic documents issued by Mongolian authorities.

ERM makes no other assessment or assertion as to the legal title of the tenements and is not qualified to do so.

#### 3.1.3 PROJECT OWNERSHIP

The Kharmagtai project is owned 38.25% by Xanadu, 38.25% by Zijin Mining Group Co. Ltd (Zijin), 13.5% by Xanadu Executive Director Ganbayar Lkhagvasuren, and 10% by QGX Ltd Through its 50% ownership of the Singaporean holding company Khuiten Metals Pte Ltd, Xanadu shares control of the project with its JV partner Zijin. Xanadu was the operator of the project for the PFS released in October 2024 (Xanadu Mines Ltd, 2024f).

For personal use only

For personal use only

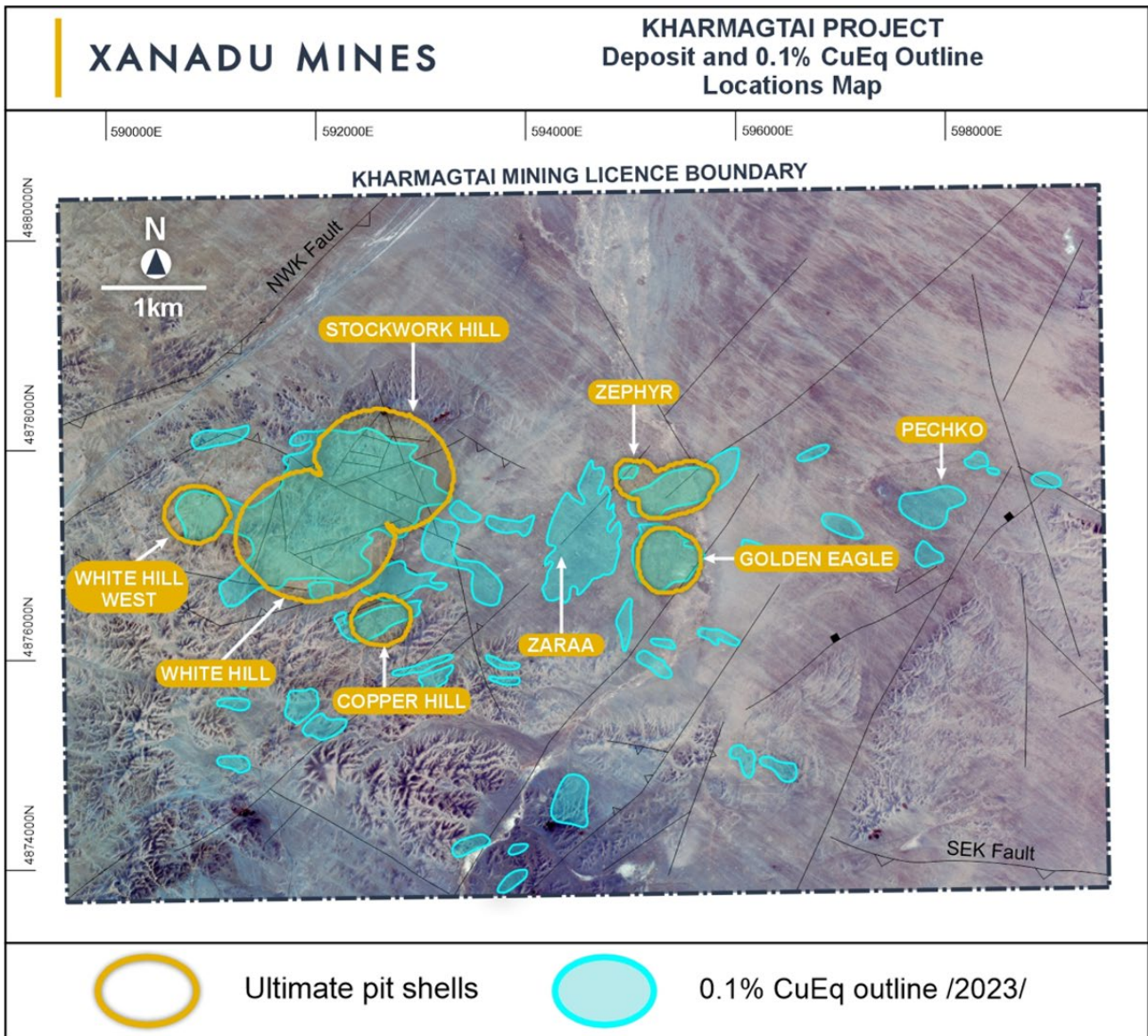

Figure 3-2: Kharmagtai mining licence coverage of the deposit. Source: Xanadu Mines

### 3.1.4 GEOLOGY

Copper-gold mineralisation at Kharmagtai is hosted within the Early Carboniferous Kharmagtai Igneous Complex (“KIC”), which was emplaced into a Late Devonian volcanosedimentary sequence (Figure 3-3, Figure 3-4). The KIC is characterised by a composite porphyritic diorite to quartz diorite intrusive complex. Mineralisation at Kharmagtai is porphyry copper-gold style, related to a series of co-genetic porphyry centres. Distal gold-base metal-bearing breccia pipes and complex silicified structurally controlled breccia zones and younger tourmaline breccia also occur.

Kharmagtai is a large and complex system, considered to have further, untested exploration potential.

For personal use only

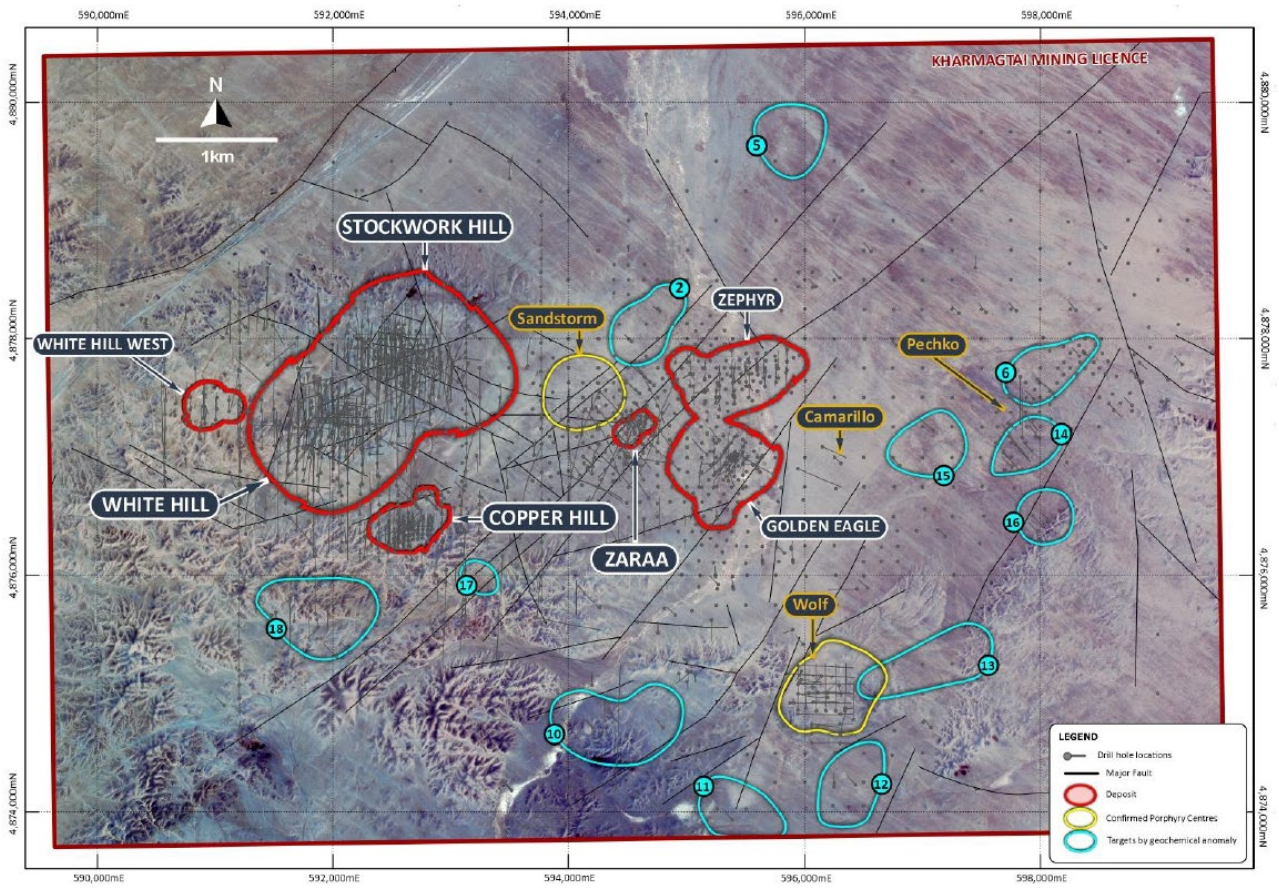

Figure 3-3: Plan view of the Kharmagtai district.

Source: (Xanadu Mines Ltd, 2024d)

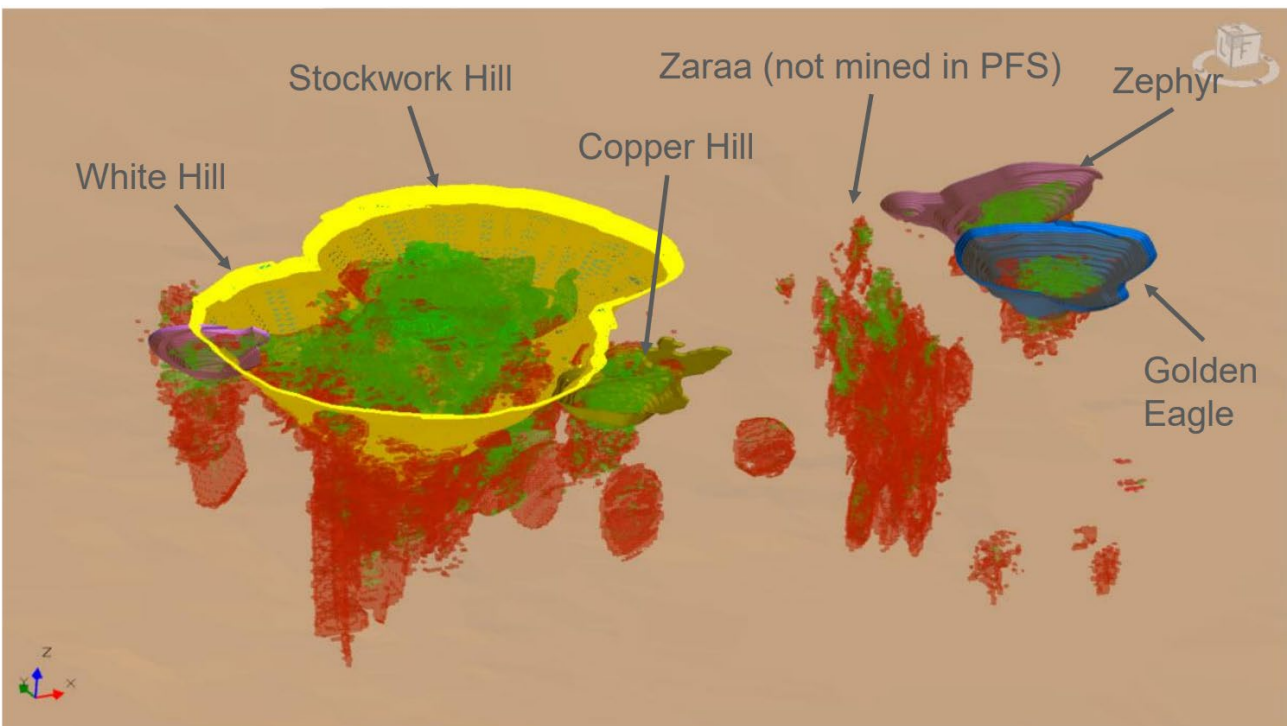

Figure 3-4: Oblique view of the Kharmagtai deposit, looking north (Xanadu Mines Ltd, 2024f)

### 3.1.5 EXPLORATION HISTORY

Five periods of historical work on the Kharmagtai project have been summarised by (O2 Mining Limited, 2024).

The first period of historical work was between 1960 and 1975, when several geological surveys and mineral exploration programmes were carried out in the Kharmagtai district with the cooperation of former Soviet Union and eastern European geological groups. Regional geological mapping, geochemistry, ground magnetics, induced polarisation (IP) (chargeability and resistivity) and airborne magnetic/radiometric surveys resulted in outcropping copper mineralisation being noted in the Kharmagtai area in 1979, and tourmaline gold mineralisation subsequently identified at Ovoot Khyar in 1980. Copper-gold mineralisation was also identified at Altan Tolgoi, Tsagaan Sudal and Zesen Uul, further establishing the regional exploration potential of the Kharmagtai area. Recognition of porphyry-style mineralisation sparked an extensive exploration programme, which involved excavation of numerous trenches and drilling of 17 shallow, widely spaced vertical diamond drill holes, which resulted in a preliminary 'Russian standard' resource estimate. Gold assays during these programmes were by atomic absorption spectrometry and were not considered to be reliable by subsequent explorers.

The second period of historical work was between 1991 and 1995, when the Japan International Cooperation Agency (JICA) and Metal Mining Agency of Japan (MMAJ) commenced mineral exploration in the South Gobi region at the request of the Mineral Authority of Mongolia. This exploration included regional reconnaissance, airborne magnetic and radiometric surveys, and based on this work Kharmagtai was re-identified as an area of porphyry-related alteration and mineralisation.

Exploration by QGX Ltd (previously Quincunx) at Kharmagtai during 1995 and 1996 included the collection of approximately 181 rock chip samples and 475 soil samples. Rock chip samples from mineralised stockwork at Stockwork Hill returned anomalous results for gold greater than 1 g/t Au. A further 2,980 soil samples were taken as part of a grid-based soil survey and the Ovoot Khyar area was identified as a priority target. In late 1996 a total of 240 line-km of ground magnetic data was collected, and 64 trenches (14.7 km total length) excavated. Exploration continued in 1997 with detailed geological mapping, trenching (2,411 m) and geophysics focused on shallow replacement-style gold mineralisation at Ovoot Khyar (OV3). This resulted in the drilling of five shallow holes (1,060 m) which intersected narrow intervals of near surface low-grade gold mineralisation (up to 0.83 g/t Au) hosted in phyllic altered sedimentary rock. This highlighted the potential for replacement-style gold mineralisation typically found in the peripheral zones of porphyry copper deposits.

Following the intersection of low-grade gold mineralisation at Ovoot Khyar in 1998, exploration by QGX moved to the previously identified porphyry copper prospects at Stockwork Hill (formerly known as KH1) and White Hill (formerly known as KH2). Detailed IP surveys were completed and six drill holes (859 m total) targeted shallow porphyry stockwork mineralisation at Stockwork Hill. Drilling confirmed the presence of porphyry-related alteration and mineralisation.

Ivanhoe Mines Mongolia (IMMI) geologists visited Kharmagtai several times between 1997 and 2001 (Kirwin, 1997). However, it was not until 2002 that IMMI made a decision to earn into the property based on encouraging geology and widespread porphyry-related alteration. Between 2002 and 2006, IMMI collected 2,960 rock chip samples, excavated 119 trenches

For personal use only

(65,636 m), and drilled 208 RC holes (27,747 m) and 172 diamond drill holes (54,269 m). Diamond drilling focused on testing and defining the Stockwork Hill, Copper Hill, White Hill, Chun, Burged and OV3 prospects. Geological mapping, stream sediment and soil sample surveys, gradient array IP (289 km), ground magnetics (589 km<sup>2</sup>), ground gravity (39 km<sup>2</sup>) and aerial magnetics and aerial gravity (259 km<sup>2</sup>) surveys were also conducted during this period. Drilling delineated multiple mineralised intercepts at Stockwork Hill, Copper Hill and White Hill. These resources were predominately near the surface and mineralisation remained open both at depth and along strike at Stockwork Hill and White Hill.

Between 2007 and 2011, Asia Gold Corp. (a subsidiary of Ivanhoe Mines) assumed control of exploration at Kharmagtai and focused on deep copper mineralisation associated with late-stage tourmaline breccia previously recognised in deeper drill holes drilled by IMMI. Fifteen diamond drill holes totalling 5,170.6 m were drilled at Kharmagtai during 2007 to test deeply seated geophysical anomalies. A detailed 3D IP survey was completed in 2011, and 19 diamond holes totalling 15,345.3 m targeted deep geophysical anomalies associated with tourmaline breccia mineralisation under the Stockwork Hill and White Hill deposits. All holes intersected broad low-grade mineralisation indicating the tourmaline breccias were part of a major copper system with significant exploration potential.

Since acquiring an interest in the project in 2014, XAM has undertaken further drilling focused on extending known mineralisation forming the deposit.

No commercial production has been undertaken on the site.

### 3.1.6 COPPER EQUIVALENT GRADE

A copper equivalent grade is used throughout studies for the Kharmagtai project. The latest copper equivalence calculation, used in the October 2024 resource estimate for the project, uses the relationship:

$$\text{CuEq} = \text{Cu (\%)} + \text{Au (g/t)} * 0.60049 * 0.86667$$

The copper equivalence formula is based on a gold price of US\$1400 / oz and copper price of US\$3.4/lb (US\$2204.6/tonne) which is considered conservative by ERM based on predicted copper and gold prices of (Consensus Economics, 2025). The formula used relates the value of contained gold and considers the expected copper recovery to concentrate of 90% and gold to copper concentrate of 78% (86.667% overall) (Xanadu Mines Ltd, 2024d).

The formula does not account for payable gold in a copper concentrate due to smelters not paying full value for contained gold and treatment charges and may, consequently, overestimate the value of contained gold.

The equivalence formula used should be improved for the project's Feasibility Study with a revision to the formula used based on long-term commodity price outlooks and smelter contract and payment terms.

### 3.1.7 KHARMAGTAI PROJECT MINERAL RESOURCES

The Kharmagtai MRE was most recently updated on 14 October 2024 (Table 3-1) (Xanadu Mines Ltd, 2024d).

For personal use only

Table 3-1: Kharmagtai project MRE (Xanadu Mines Ltd, 2024d)

Cut-off (% Cu Eq)	Classification	Tonnes (Mt)	Grades			Contained Metal		
			Cu Eq (%)	Cu (%)	Au (g/t)	Cu Eq (kt)	Cu (kt)	Au (koz)
Open Cut (0.13%)	Indicated	1,300	0.30	0.21	0.16	3,800	2,700	6,800
	Inferred	800	0.25	0.18	0.12	1,900	1,400	3,000
	Total	2,100	0.28	0.20	0.14	5,700	4,100	9,800
Underground (0.30%)	Indicated	40	0.45	0.32	0.24	150	100	250
	Inferred	160	0.41	0.31	0.19	650	500	950
	Total	200	0.42	0.31	0.20	800	600	1,200
<b>Kharmagtai Total</b>		<b>2,200</b>	<b>0.29</b>	<b>0.21</b>	<b>0.15</b>	<b>6,500</b>	<b>4,700</b>	<b>11,000</b>

- CuEq (lbs and t) accounts for Au (g/t) value and CuEq (t) must not be totalled to Au ounces
- Figures may not sum due to rounding
- Significant figures do not imply an added level of precision
- Resource constrained by 0.1%CuEq reporting solid in line with geological analysis by XAM
- Open Pit Resource constrained by RV1400fpit (coded field equal to 1)
- Open Pit cut-off at 0.13% CuEq, consistent with the PFS marginal cut-off; Underground cut-off at 0.3% CuEq
- Resource CuEq equation (CuEq=Cu+Au\*0.60049\*0.86667) where Au at \$1400/oz and Cu at \$3.4/lb was employed according to the Clients' (XAM) direction.
- Au recovery is relative with Cu rec=90% and Au rec=78% (rel Au rec=78/90=86.667%) with number according to the Clients' (XAM) direction
- Model: KH ALL GLOBAL OKMOD FINAL V3 FORCLIENT 140624 inRV1400fpit

For personal use only



ERM considers the Kharmagtai MRE to be estimated, classified and reported in accordance with the JORC Code (JORC, 2012)

The geological model and associated MRE are considered by ERM to comprise a suitable basis for estimation of Ore Reserves and the project's PFS. ERM would prefer a resource estimate associated with a greater degree of confidence in the form of some Measured Resources and a greater proportion of Indicated Mineral Resources in the portions of the deposit potentially amenable to open cut mining. This is particularly the case where ore is proposed to be mined during the capital payback period for the project. Additional drilling and sampling required to achieve this should be considered by XAM prior to completion of the project's Feasibility Study.

Kharmagtai is currently a project at PFS stage based on a conventional open pit, truck and shovel operation feeding a copper concentrator. Xanadu considers that the Ore Reserve is supported by the PFS, which will be updated upon completion of the project's Feasibility Study.

## 3.2 RED MOUNTAIN PROJECT

### 3.2.1 LOCATION, ACCESS AND PHYSIOGRAPHY

The Red Mountain porphyry copper-gold project is located within the Dornogovi Province of southern Mongolia, approximately 420km southeast of Ulaanbaatar (Figure 3-1). Access to the project is by four-wheel drive along unpaved roads from the regional centre at Sainshand 70 km east of the project area. Sainshand is connected to Ulaanbaatar and the Chinese border via the trans-Mongolian railway and a paved highway.

Red Mountain lies on a desert steppe and consists of gravel covered plains with low hills. The project area ranges from 1050 m to 1100 m above sea level and has a relatively flat undulating topography.

### 3.2.2 OWNERSHIP

The Red Mountain project is 100% owned by XAM, through ownership of Vantage LLC.

### 3.2.3 TENEMENTS

The project is held under a single mining licence (MV017129), which covers approximately 57 square kilometres (Figure 3-5). The licence is held by Vantage LLC, a Mongolian registered subsidiary of XAM. It was issued on 12 September 2012 and expires on 12 September 2042.

ERM was provided with a signed and stamped copy of the mining licence document and accompanying schedule issued by the Mongolian government by XAM. ERM considered the documents provided to be authentic documents issued by Mongolian authorities.

ERM makes no other assessment or assertion as to the legal title of the tenements and is not qualified to do so.

### 3.2.4 EXPLORATION HISTORY

Previous exploration was conducted by Quincunx Ltd, Ivanhoe Mines Ltd and Turquoise Hill Resources Ltd including extensive drilling, surface geochemistry, geophysics, mapping.

For personal use only



For personal use only

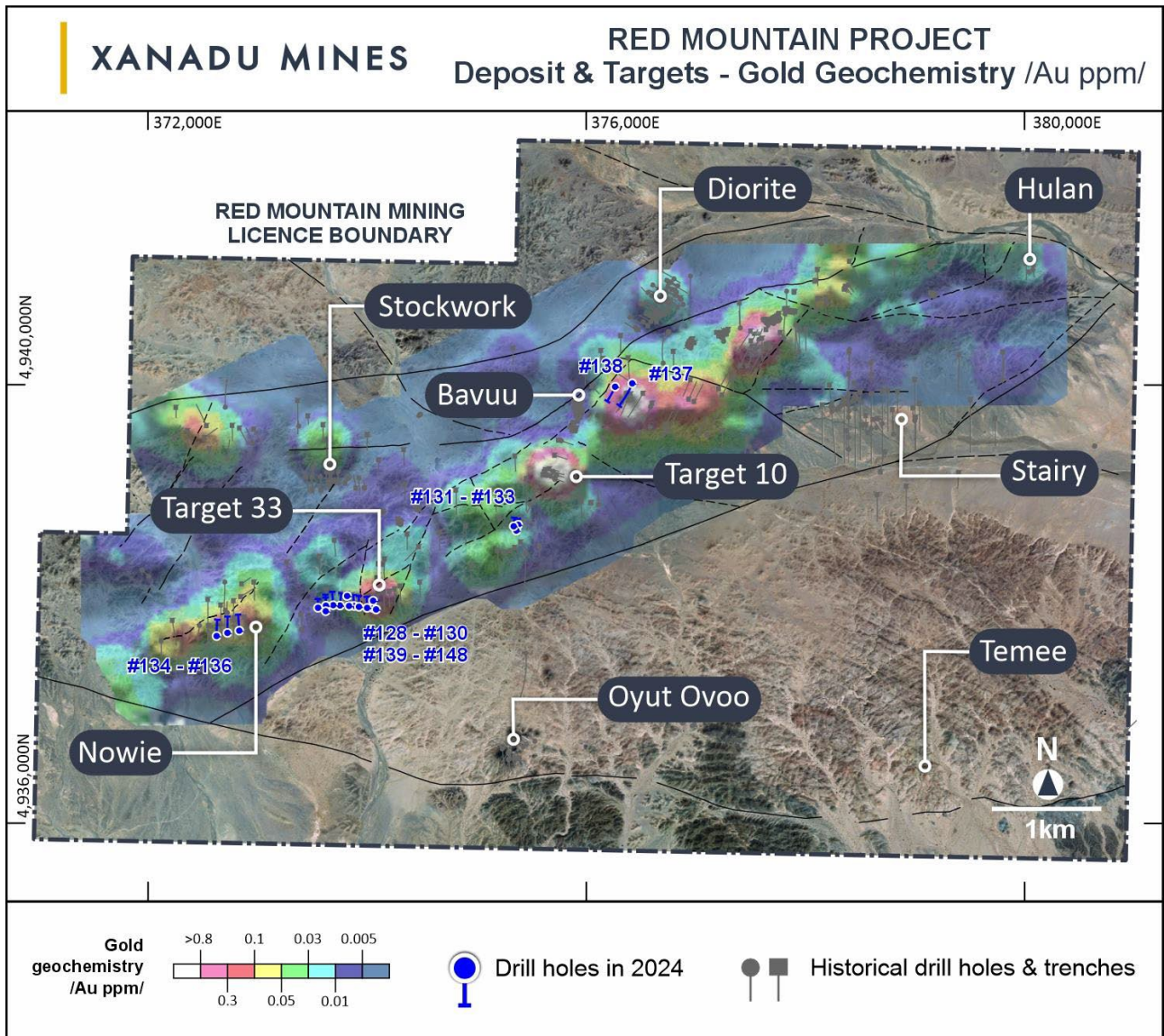

Figure 3-5: Red Mountain mining licence boundary in relation to prospects forming the Red Mountain deposit (Xanadu Mines Ltd, 2024b)

Mineral exploration at Red Mountain commenced in the 1960s, with joint Russian-Mongolian teams undertaking regional assessment of the South Gobi porphyry province (Mining Associates, 2018). Reconnaissance work defined outcropping mineralisation and some evidence of ancient workings (pitting and slag). Mapping, geochemistry and geophysics defined ten prospects that were tested with trenching and shallow vertical drill holes.

In 2003 Ivanhoe Mines Mongolia (IMMI) completed 1:10,000 scale geological mapping and rock chip sampling (1957 grab samples), and based on encouraging results drilled 16 shallow diamond drill holes (4041 m) targeting outcropping mineralisation at Stockwork Hill, Diorite and Breccia Pipe prospects (Mining Associates, 2018). In 2005 exploration focused on the Stairy and Hulan Prospects, where 13 trenches (6890 m) and 917 rock samples were taken. Exploration in 2007 focused on the Nowie and Southeast prospects where 3D-IP/resistivity surveys were completed, and follow-up exploration included three trenches (1140 m) and six diamond drill holes (1119.40 m).

Temujin Mining Corp (TMC), a privately owned Canadian company, acquired the licence from IMMI in 2009. Between 2009 and 2011 exploration by TMC confirmed the presence of porphyry copper-gold mineralisation (Mining Associates, 2018). Work by TMC included a regional soil geochemical survey (4,461 samples), trenching (14 trenches totalling 1419.50 metres) and a geophysical survey that included an IP/resistivity survey (12 lines totalling 27.30 km) and ground magnetics. A programme of shallow and widely spaced diamond drilling was completed (19 holes totalling 3,336 m).

Xanadu commenced negotiations to purchase Red Mountain from TMC in May 2012. During an initial earn-in period in the same year, Xanadu drilled 10 holes for 2,508 m in targets at Diorite Hill, Stockwork Porphyry and Aplite prospects. Xanadu has completed acquisitions to secure 100% ownership of the Red Mountain project.

### 3.2.5 GEOLOGY AND MINERALISATION

The porphyry mineralisation at Red Mountain is associated with late-stage monzonite and quartz diorite porphyry dykes and stocks emplaced on the flanks of the RMIC. Alteration and mineralisation at Red Mountain are characterised by multiple co-genetic copper-gold porphyry centres, tourmaline breccia pipes and copper-gold/base metal magnetite skarns.

In March 2021, XAM commissioned Spiers Geological Consultants (SGC) illustrate the regional potential of the mineralisation occurrences observed throughout the Red Mountain region by way of preliminary estimates for copper and gold mineralisation within the project area. These preliminary estimates were Unclassified and therefore could not be released in line with public reporting codes. This exercise supports the prospectivity of the area and shows that further exploration is justified.

## 3.3 SANT TOLGOI PROJECT

### 3.3.1 LOCATION

The Sant Tolgoi Cu-Ni project is located in the Zavkhan Province of western Mongolia, approximately 750 km northwest of the Mongolian capital, Ulaanbaatar (Figure 3-1).

### 3.3.2 PROJECT OWNERSHIP

Sant Tolgoi project hosts multiple shallow copper-nickel targets over several kilometres of strike. XAM entered into a binding term sheet with Mongolian based company STSM LLC (STSM) in January 2024 to earn up to 80 per cent of the project (Philipps, 2024) The agreement with STSM covers the Oyut and Sant Tolgoi exploration licences. Once the minimum commitment has been met, Xanadu can elect to proceed to the first stage of the deal and earn a 51 per cent interest in the project by spending US\$1 million (AU\$1.5 million) on exploration over 24 months.

Once the first stage of the arrangement is complete, STSM can elect to end the farm-in agreement and form a JV, with Xanadu to become the manager of the project with 51 per cent, while STSM holds the remaining 49 per cent.

Xanadu can earn a further 29 per cent in the project by sole funding a another US\$10 million (AU\$15.1 million) on exploration prior to transferring the exploration licence into a mining lease.

At the completion of the Stage 3 Farm-In, XAM will hold an 80 per cent interest in the project and STSM 20 per cent. At this point, STSM will contribute pro rata to further exploration expenditures (Xanadu Mines Ltd, 2024g).

While the deal is binding in nature, XAM stated that the term sheet is intended to be replaced by a formal agreement governing the full terms and conditions of the farm-in transaction, which will be negotiated between the two parties.

### 3.3.3 TENEMENTS

The Sant Tolgoi project consists of two exploration licences, XV-17774 (Oyut) and XV-21887 (Sant Tolgoi) with a combined area of over 40 km<sup>2</sup> (Figure 3-6).

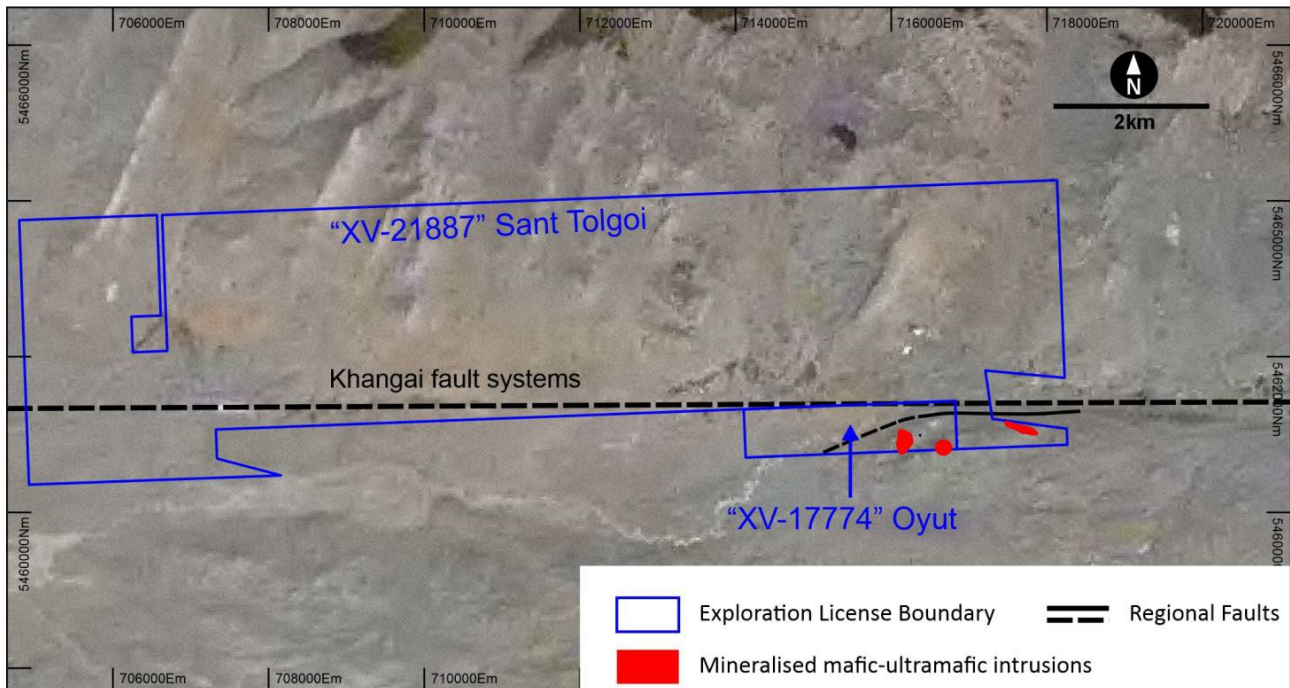

Figure 3-6: Sant Tolgoi Tenure

Source: (Xanadu Mines Ltd, 2024a)

The tenure information summarised here has been extracted from XAM ASX releases but was not able to be independently confirmed. The licence is held by STSM LLC and XAM is yet to secure equity in the project. ERM makes no other assessment or assertion as to the legal title of the tenements and is not qualified to do so. A copy of the executed Farm in Agreement between XAM and STSM was sighted by ERM. XAM had not satisfied requirements to secure initial equity in the project at the effective date of this report. No value has been assigned to the project by ERM for this reason. This is discussed further in Section 8.7 of this report.

### 3.3.4 EXPLORATION HISTORY

ERM was unable to locate substantive records of previous exploration in the project area. XAM reported in October 2024 that exploration was "well underway" with:

- detailed geological mapping and geochemical sampling in progress and
- acquisition of high resolution magnetic, gravity and CSAMT data had been completed to help recognise targets for more detailed exploration (Xanadu Mines Ltd, 2024g).

### 3.3.5 GEOLOGY AND MINERALISATION

The Sant Tolgoi project is interpreted to lie on the western extension to the of the deep seated Khangai Fault systems (Figure 3-7), a metalliferous fault network which hosts several significant mafic and ultramafic intrusions that are considered to be encouraging for intrusion hosted copper and nickel mineralisation (Xanadu Mines Ltd, 2024c).

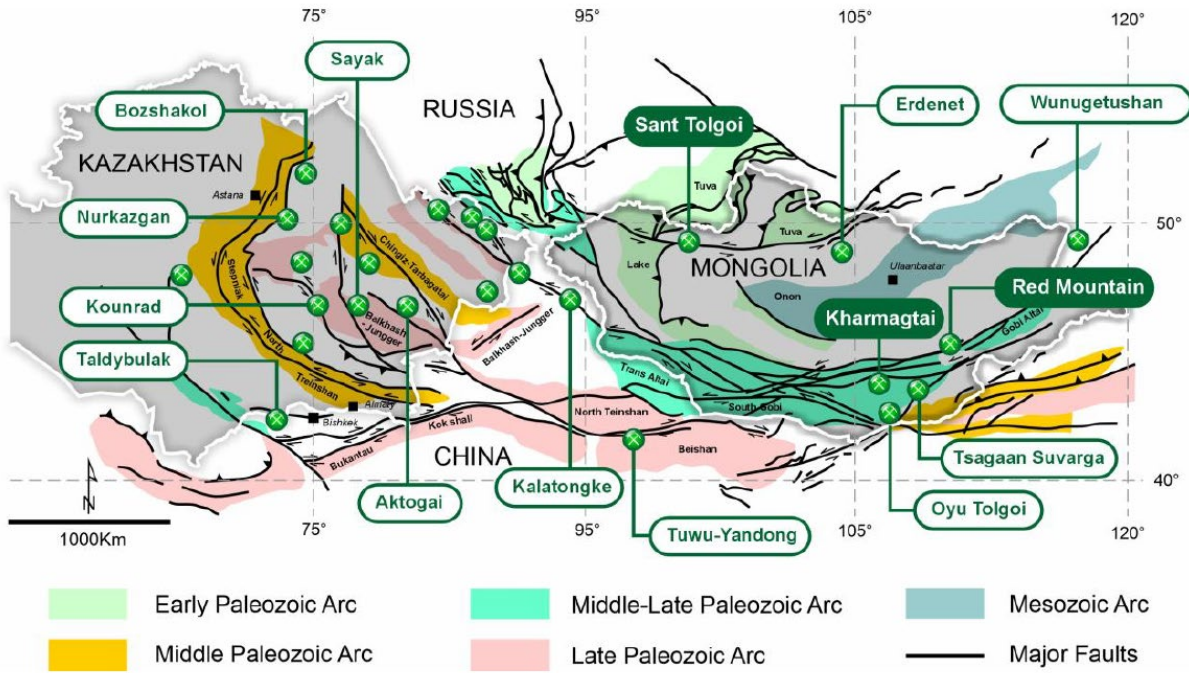

Figure 3-7: Sant Tolgoi regional setting.

Source: (Xanadu Mines Ltd, 2024a)

Mineralisation at Sant Tolgoi consists of copper oxides hosted within coarse grained gabbro (Figure 3-8). Copper is expressed as secondary, remobilised by weathering in fractures and as staining. This is interpreted to have been remobilised from primary disseminated and massive sulphides below the weathering profile.

In November 2024, XAM reported strong surface copper assay results, with geological mapping, surface rock chip sampling and geophysics confirming the presence of several large anomalies associated with outcropping mafic intrusions (Figure 3-8). The objective of the multidiscipline exploration programme is to collect the data required to identify drill targets within the large Sant Tolgoi Intrusive Complex, with four targets currently identified (Figure 3-9). XAM report that a total of 3000m of reconnaissance drilling has been planned to test all targets for high-grade massive sulphide copper and nickel, with follow-up drilling to commence in Q2 2025 (Xanadu Mines Ltd, 2024c).

For personal use only

### Sant Tolgoi Project Interpreted Geological Map

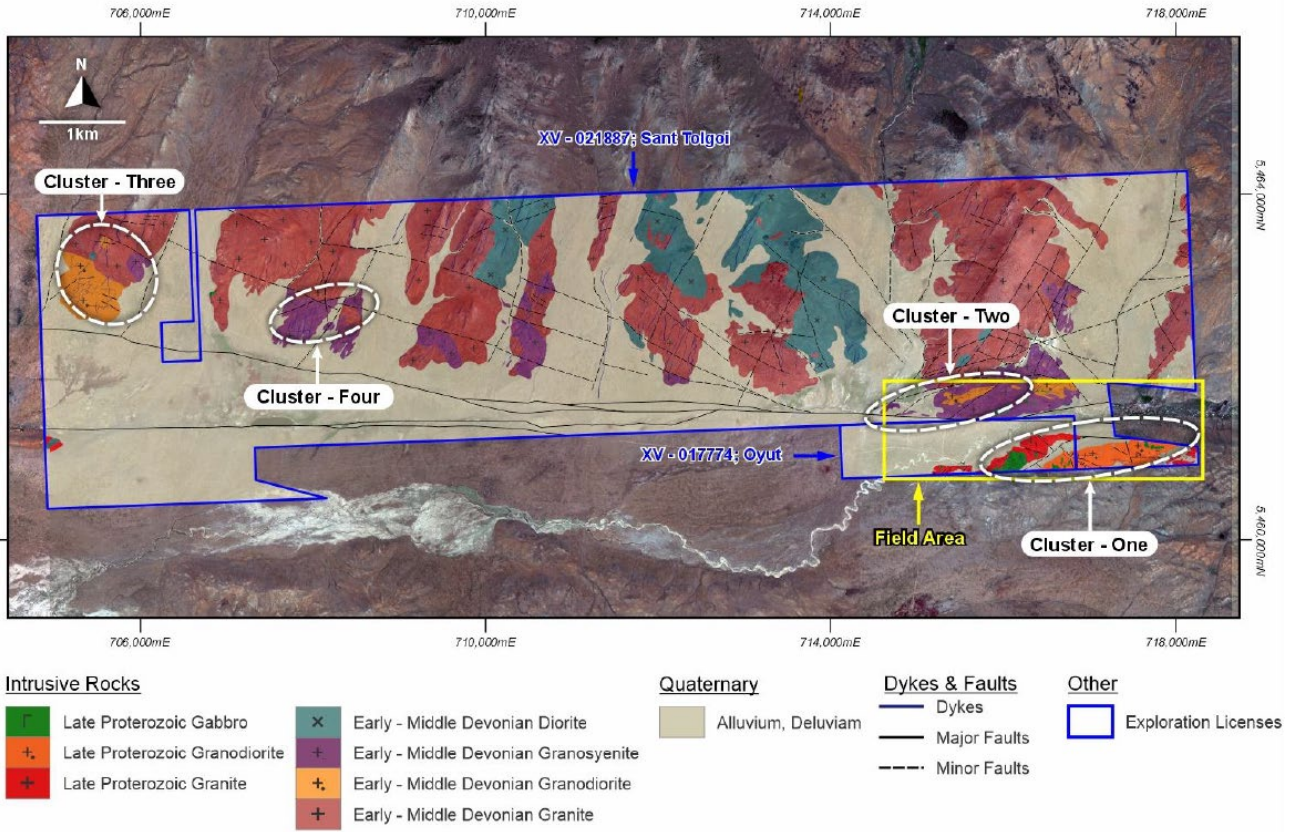

Figure 3-8: Interpreted geology of Sant Tolgoi project area.

Source: (Xanadu Mines Ltd, 2024c)

### Field Area - Geochemistry Image & Rock Chip Locations (Cu ppm)

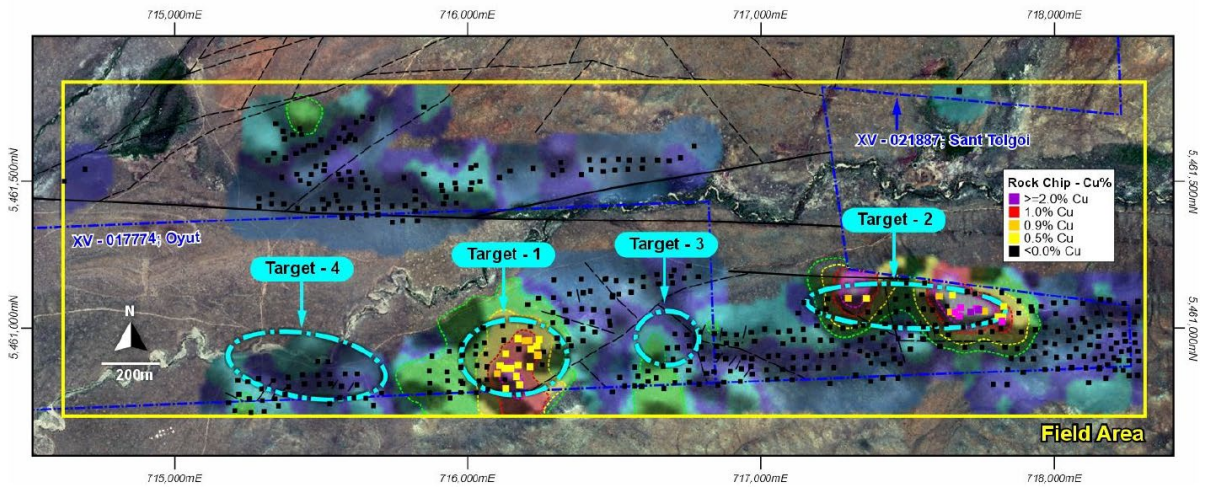

Figure 3-9: Field Area copper rock chip results.

Note: Refer to yellow box in southern portion of Figure 3-8 for location of Field Area.

Source: (Xanadu Mines Ltd, 2024c)

For personal use only

## 4. MINING: KHAMRAGTAI PROJECT

### 4.1 REVIEW SCOPE

ERM reviewed proposed mining options and plans for the Kharmagtai project and validated inputs to the project financial model. This included an assessment of the reasonableness of each of the assumptions used in the cash flow model ('Model'), including the following:

- Mineral Resources and Ore Reserves incorporated into the Model and the treatment of any residual
- mining physicals (including tonnes of ore mined, quality, waste material and mine life)
- mining operating costs (including but not limited to drilling, blasting, mining, haulage, transport, general administration, distribution and marketing, contingencies and royalties or levies)
- mining CAPEX (including but not limited to pre-production costs, project capital costs, sustaining CAPEX, salvage value, rehabilitation and contingency)
- any other relevant mining assumptions not specified above

### 4.2 DOCUMENTS AND DATA PROVIDED FOR REVIEW

ERM reviewed the following documents in developing an understanding of the value of the projects and of the parameters used:

- 01.01.01 2024.06 - Xanadu Teaser.pdf
- investor presentations
- annual Reports
- 02.10.01 XAM and KHJV Cash Flow Forecasts 30Aug24 Consolidated.xlsx

#### **Khuiten (Kharmagtai) Project:**

- block model - 03.03.01.04.08 kh\_090924\_reg\_202010.dm
- Deswik file - 03.03.01.04.05 MP10729\_Khuiten\_Kharmagtai\_OP\_PFS\_Detailed Design File.dcf
- pit shell - 03.03.01.04.06 MP10729 Khuiten - Kharmagtai - Ultimate WH\_SH Pit Shellpt.dxf
- documents:
  - 03.03.01.04.07 DRAFT O2M2301-ADM-PFS 07 Mining Geotechnical Rev B MP.docx,
  - 03.02.04 4.1 Khuiten JV Budget 2024.docx, 03.03.01.01.01 2024.10.14 - Kharmagtai PFS Results Summary.pdf
- Spreadsheets:
  - 03.03.01.02.01 Kharmagtai PFS Fin Model V10 Base Case 15\_Project \_Reviews\_SCV10A - silver.xlsx,
  - 03.03.01.02.02 Kharmagtai PFS Model (Simplified Version).xlsx

- 03.03.01.02.03 Kharmagtai PFS Model (Reserves Only).xlsx
- 03.03.01.04.01 MP10729 Kharmagtai - Mining Cost Model-241003\_V3.1.xlsx
- 03.03.01.04.02 MP10729 Khuiten - Kharmagtai - Schedule Export Data\_V3.1\_06102024.xlsx
- 03.03.01.04.03 MP10729 Khuiten - Kharmagtai - Deswik Mining Data Summary\_26092024.xlsx

### 4.3 ORE RESERVES

The Mineral Resources for the Kharmagtai project have been presented previously in Table 3-1.

#### 4.3.1 ORE RESERVE ESTIMATE

A maiden Ore Reserve for the project was also published on 14 October 2024 (Table 4-1, Table 4-2).

Table 4-1: Kharmagtai project Ore Reserve (Xanadu Mines Ltd, 2024f)

Classification	Tonnes (Mt)	CuEq (%)	Cu (%)	Au (g/t)	CuEq (kt)	Cu (kt)	Au (koz)
<b>Proved</b>							
<b>Probable</b>	730	0.30	0.21	0.17	2179	1,600	4,000

Table 4-2: Kharmagtai project Ore Reserve by Deposit (Xanadu Mines Ltd, 2024f)

Deposit	Tonnes (Mt)	Cu (%)	Au (g/t)	Cu (kt)	Au (koz)
<b>Stockwork Hill</b>	233	0.22	0.21	520	1,600
<b>White Hill</b>	437	0.21	0.14	930	2,000
<b>Copper Hill</b>	22	0.26	0.17	60	200
<b>Golden Eagle</b>	13	0.12	0.31	20	100
<b>Zephyr</b>	16	0.15	0.19	20	100
<b>White Hill West</b>	11	0.16	0.11	20	40
<b>Total</b>	732	0.31	0.21	1570	4040

- figures may not sum due to rounding
- Ore Reserve constrained by Kharmagtai PFS mine plan inventory
- Ore Reserve CuEq equation ( $CuEq=Cu+Au*0.7039Au$ ) where Au at USD\$1900/oz and Cu at USD\$4.0/lb was employed according to the Clients' (XAM) direction
- Au recovery is relative with Cu rec=80% and Au rec=81% according to the Clients' (XAM) direction

To support the Ore Reserve evaluation within the PFS, a Whittle 4X open pit optimisation was completed by XAM's consultants with no value given to the Inferred Resource material.

Following this a PFS level mine design, mine scheduling, mining costing and overall project

For personal use only



economic model evaluation was completed to confirm positive economic outcomes for the Ore Reserve. A marginal breakeven cut-off of 0.13% CuEq was adopted based on economic parameters and recoveries determined as part of the PFS study.

The Probable Ore Reserve reported for the Kharmagtai deposit is based on Indicated Mineral Resources and diluting material within a regularised resource block model. Diluting material is either low-grade Indicated Mineral Resource or material carrying no grade. No Measured Mineral Resource has been publicly reported for the Kharmagtai deposit.

Resource classifications are based on an assessment of geological confidence and geological and mineralisation continuity as outlined in the MRE reported for the project which includes JORC Table 1 summaries for the Mineral Resource and Ore Reserve estimates (Xanadu Mines Ltd, 2024d).

Measured Mineral Resources usually form the basis of Proved Ore Reserves with the application of appropriate modifying factors and work to ensure that the Ore Reserves are economically mineable under the conditions described in the Ore Reserve statement. A portion of a deposit's Measured Mineral Resources may convert to Probable Ore Reserves when mining assumptions, for example minimum mining widths or selective mining units, are applied. Indicated Mineral Resources may form the basis of Probable Ore Reserves following a similar process. Inferred Mineral Resources are classified as not having sufficient confidence to be used as the basis for Ore Reserves.

The PFS production schedule includes a proportion of Inferred Resource mineralisation. This practice is not unusual in scoping studies, and less commonly in prefeasibility studies. The Inferred Mineral Resource mineralisation is estimated to be present at much lower confidence than Indicated and Measured Mineral Resources on which Ore Reserves are based. Production schedules that incorporate Inferred Mineral Resource mineralisation are consequently much less confident predictions of future production potential than schedules based entirely on Probable and Proved Ore Reserves. The practice of including Inferred Mineral Resources in Feasibility Study or production schedules is, however, considered to be acceptable by ERM for long-life mines where project economics are enhanced by not having to undertake extensive infill drilling prior to commencing mining of mineralisation scheduled to be mined later years of the mine's projected life. This enables required Mineral Resource infill drilling to be funded from operating revenue and completed in advance of mining to enable Ore Reserves to be estimated and incorporated in medium to long term planning. In scoping, prefeasibility and feasibility studies, the Inferred Mineral Resource material in schedules is able to be identified and prioritised for further resource evaluation drilling required to increase the confidence of Mineral Resource estimates and corresponding estimation of Ore Reserves in advance of mining.

The PFS mining inventory is primarily in the Indicated Resource classification, however, there is a component of Inferred Resource material in later years of the mine plan (Figure 4-1). All material planned to be mined in the Feasibility Study should comprise Proved and Probable Ore Reserves which will require additional drilling in areas identified to have open pit mining potential by pit optimisations developed for the project's PFS. This work would, ideally, be completed prior to commencement of the project's Feasibility Study

For personal use only



ERM proposes that the Kharmagtai project Ore Reserves have been estimated, classified and reported in an appropriate manner and comply with the requirements of the JORC Code (JORC, 2012).

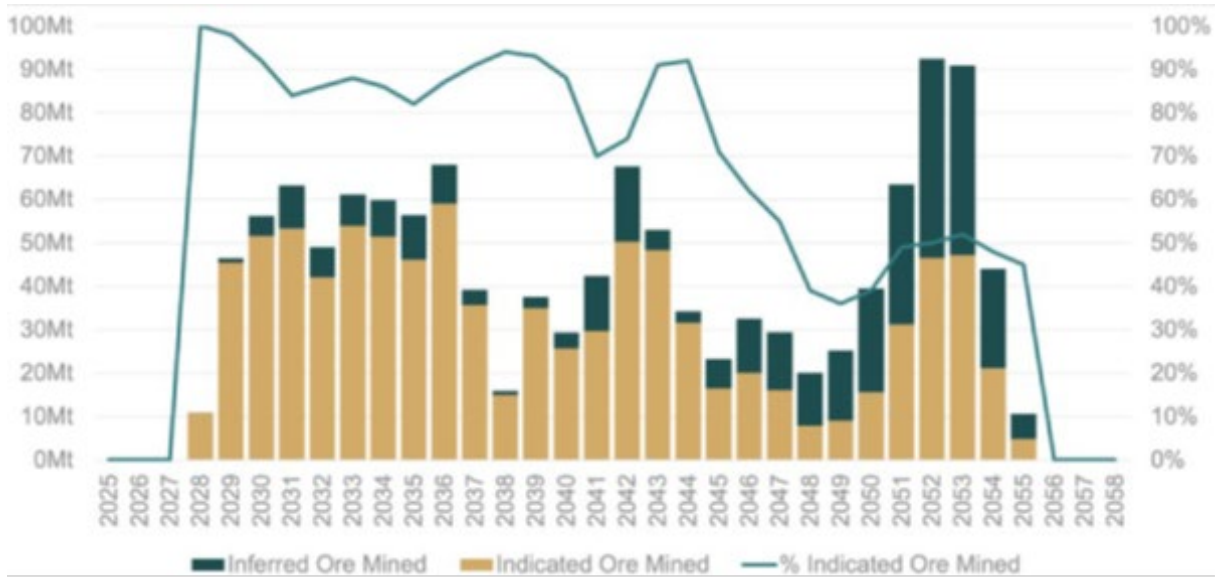

Figure 4-1: Annual ore production by Mineral Resource category.

### 4.3.2 MINERAL RESOURCE ESTIMATE EXCLUSIVE OF ORE RESERVES

ERM used the project’s Mineral Resource and Ore Reserve estimates to estimate Mineral Resources not included in optimal open pit shells developed or the project (Table 4-3). An allowance for 5 per cent ore loss was applied in this calculation.

The distribution of Mineral Resources not included in optimal open pits developed for the project is evident in Figure 3-4.

### 4.4 MINING STUDY KEY FINDINGS

From a mining engineering viewpoint

- The Kharmagtai project is a large copper project suitable for open pit mining. In the first few years, the stripping ratio is around 0.65 tonnes of waste per tonne of ore, lowering the operating costs.
- Contractor Mining is considered to lower the Capital costs.

Some of the key comments are:

- The overall initial CAPEX for the project is significantly lower than that estimated for comparable projects in Mongolia and neighbouring Kazakhstan but has been prepared for the project’s PFS in a rigorous manner consistent with industry best practice.

For personal use only

Table 4-3. Mineral Resources Exclusive of Ore Reserves

Cut-off (% Cu Eq)	Classification	Tonnes (Mt)	Grades			Contained Metal		
			Cu Eq (%)	Cu (%)	Au (g/t)	Cu Eq (kt)	Cu (kt)	Au (koz)
Open Cut (0.13%)	Indicated	5,534	0.29	0.20	0.15	1,520	1,064	2,607
	Inferred	800	0.25	0.18	0.12	1,900	1,400	3,000
	<b>Total</b>	<b>1,334</b>	<b>0.26</b>	<b>0.19</b>	<b>0.13</b>	<b>3,420</b>	<b>2,464</b>	<b>5,607</b>
Underground (0.30%)	Indicated	40	0.45	0.32	0.24	150	100	250
	Inferred	160	0.41	0.31	0.19	650	500	950
	<b>Total</b>	<b>200</b>	<b>0.42</b>	<b>0.31</b>	<b>0.20</b>	<b>800</b>	<b>600</b>	<b>1,200</b>
<b>Kharmagtai Total</b>		<b>1,534</b>	<b>0.28</b>	<b>0.20</b>	<b>0.14</b>	<b>4,220</b>	<b>3,064</b>	<b>6,807</b>

- 5% ore loss applied
- CuEq (lbs and t) accounts for Au (g/t) value and CuEq (t) must not be totalled to Au ounces
- Figures may not sum due to rounding
- Significant figures do not imply an added level of precision
- Resource constrained by 0.1%CuEq reporting solid in line with geological analysis by XAM
- Open Pit Resource constrained by RV1400fpit (coded field equal to 1)
- Open Pit cut-off at 0.13% CuEq, consistent with the PFS marginal cut-off; Underground cut-off at 0.3% CuEq
- Resource CuEq equation (CuEq=Cu+Au\*0.60049\*0.86667) where Au at \$1400/oz and Cu at \$3.4/lb was employed according to the Clients' (XAM) direction.
- Au recovery is relative with Cu rec=90% and Au rec=78% (rel Au rec=78/90=86.667%) with number according to the Clients' (XAM) direction
- Model: KH ALL GLOBAL OKMOD FINAL V3 FORCLIENT 140624 inRV1400fpit

For personal use only



- Royalties were assumed at 8.36% for Cu and 5% for Au. Royalty rates in Mongolia, however, depend on metal prices and can be up to 20% under the current Minerals Law when the copper price exceeds US\$9,000/t, which is the case in the Kharmagtai PFS. The actual royalty rate applicable to the project is able to be set by negotiations between XAM and the Mongolian government to establish the project's investment agreement.
- There is an apparent mismatch between the shovel size selected for the project and the proposed mining bench height of 10m. A higher bench would be more efficient and reduce operating costs with the equipment selected. ERM proposes that adopting a higher bench height with the excavators elected for the project could realise cost reductions in the order of ten to 15 per cent for the rope shovels selected for the project. ERM proposes that this is unlikely to materially influence the project's valuation but does represent an opportunity for future improvement.
- Options for reducing stockpile sizes need to be considered.

There are additional, less significant issues requiring attention in:

- placement of ramp exit points at open pit crests
- removal of sudden changes in ramp direction and
- ensuring that there is adequate working room and access to the deeper benches of all open pits.

These latter issues are unlikely to be material to the overall economics of the project.

#### 4.4.1 MINING APPROACH

The Kharmagtai project is potentially amenable to open pit mining in its early years of development, and has longer term potential for development of an underground, bulk mining operation, recovering ore from the deeper portions of Stockwork Hill, Copper Hill and White Hill, and deeper mineralisation such as Zaraa (Figure 4-2, Figure 4-3).

Mineralisation at Kharmagtai extends beyond the base of the current open pit mining potential identified by the project's PFS, and potential for delineation of extensions to existing deposits and discovery of new mineralised systems also exists.

Ore processing is proposed to be undertaken on-site using a combination of flotation for copper recovery and both gravity and carbon-in-leach (CIL) recovery for gold.

The area in which the project is located has existing road, rail and electricity infrastructure but the ability of the latter to support a new mine development requires confirmation, particularly for water (Figure 4-3). Electricity is available through an existing connection to the Chinese electricity grid in Inner Mongolia. The project's water requirements are expected to be met initially by groundwater from a local aquifer and, longer term, by a planned pipeline project to deliver water to the South Gobi region from northern Mongolia. Confirmation of water availability is an important issue, discussed further below.

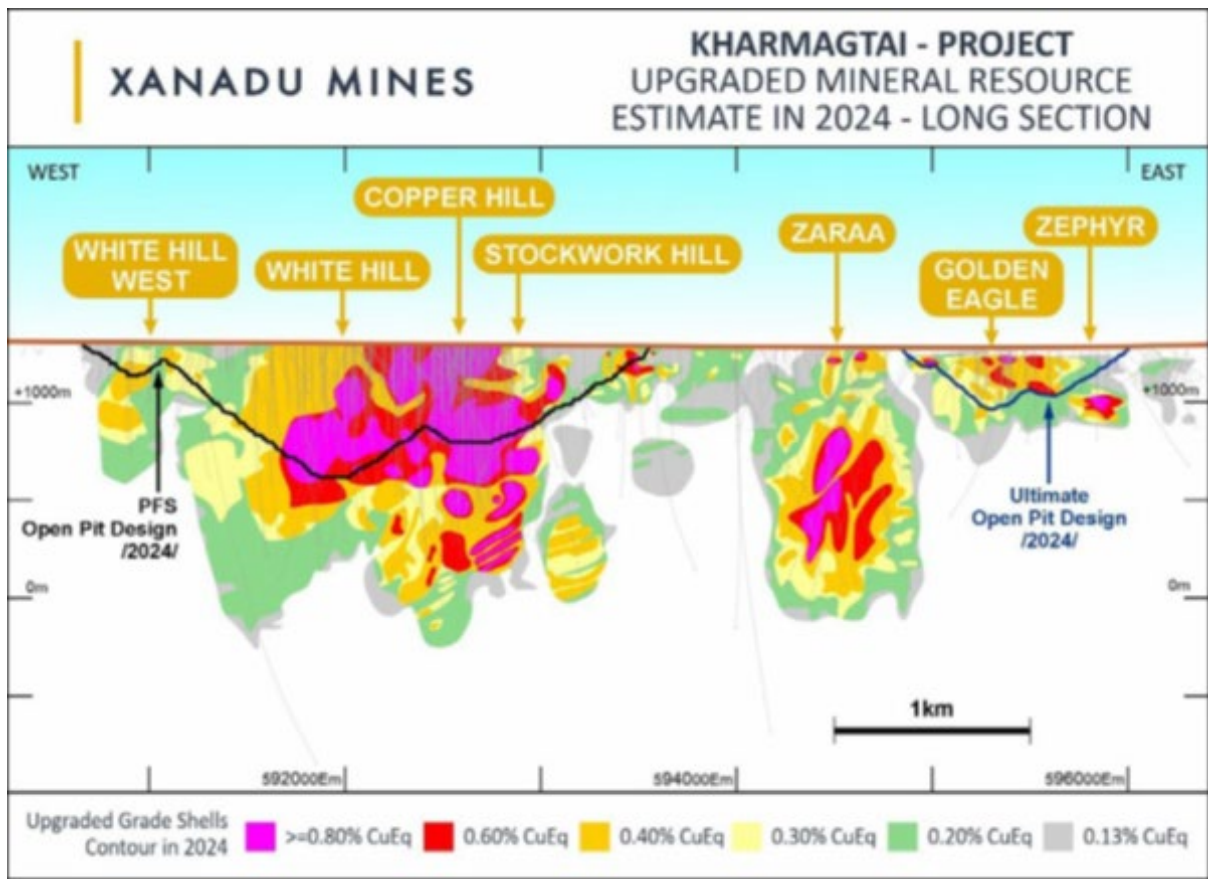

Figure 4-2: Kharmagtai deposit long section showing 2024 open pit designs. Mineralisation at depth beneath and between the open pits represents untested potential for future underground mining.

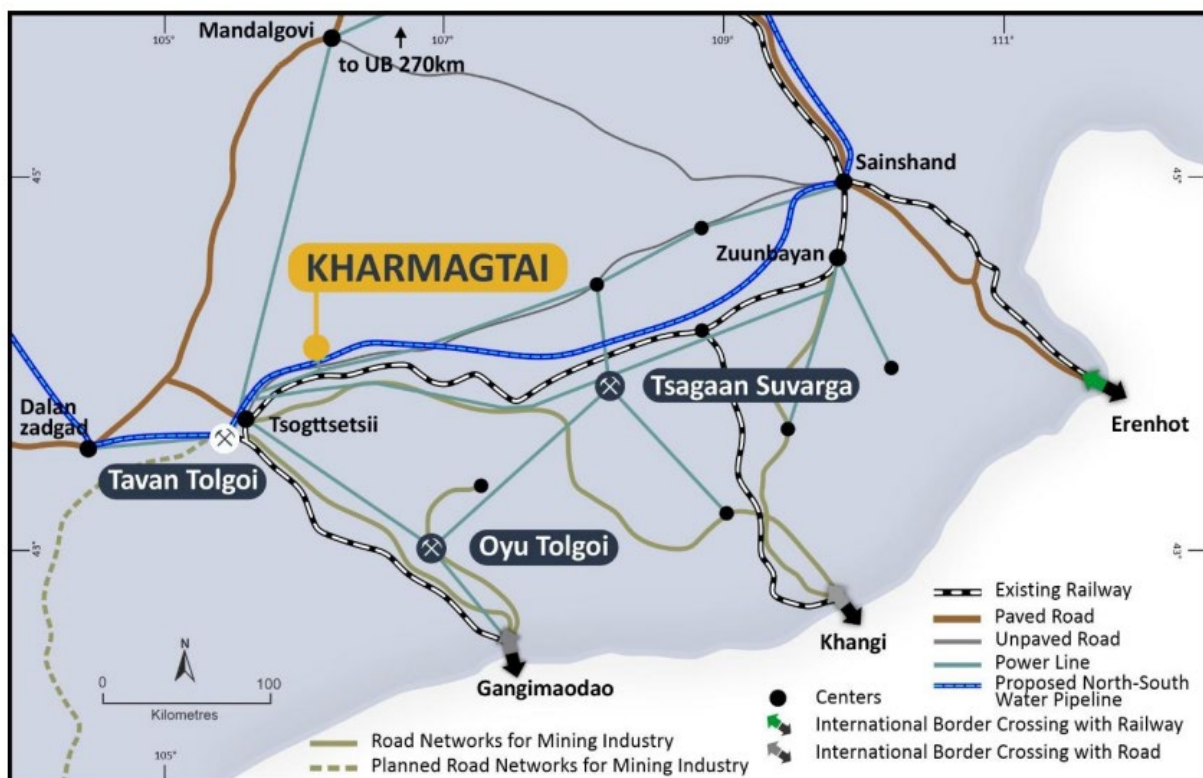

Figure 4-3: Kharmagtai project area infrastructure (Xanadu Mines Ltd, 2024e)

For personal use only

## FEASIBILITY STUDY REVIEW

Key assumptions used in the PFS comprise:

1. copper Price US\$4.1/lb (US\$9,036/t)
2. gold price US\$2,100/ounce
3. initial CAPEX US\$890 million

## BLOCK MODEL

The block model provided appeared to be regularised (from the name 03.03.01.04.08 kh\_090924\_reg\_202010.dm). The block size is appropriate for the size of the deposit and the equipment selected.

As previously mentioned, the project has several zones, some of which have been excluded from the block model at this stage (e.g. Zaraa, Figure 4-2).

A bench height of 10m was selected. The PFS states that the bench height matches the equipment selected, but the main rope shovels selected (P&H 4100 XPC Electric) have a cut height of 17 metres and may be less efficient if they are used to excavate 10m high benches. This requires further review as the project progresses.

Because the model was regularised to 20x20x10m, no additional dilution or loss was added.

### 4.4.1.1 OPEN PIT OPTIMISATION

Pit optimisation was performed using Whittle 4X open pit optimisation software. No value was assigned to the Inferred Mineral Resource material included in the optimum pit shells derived for the project. The selected pit shells guided the pit designs.

No additional information, parameters or inputs were provided for the pit optimisations prepared for the project.

PFS level mine design, mine scheduling, mining costing and overall project economic model evaluation was completed to confirm positive economic outcomes for the Ore Reserve. A marginal breakeven cut-off of 0.13% CuEq was adopted based on economic parameters and recoveries determined as part of the PFS study.

## OPEN PIT, WASTE DUMP AND STOCKPILE DESIGNS

Mining Plus prepared designs for the pits, waste dumps, topsoil and ore stockpiles. The site layout proposed by Mining Plus is presented in Figure 4-4, Figure 4-5.

It must be noted that the Deswik design file (03.03.01.04.05 MP10729\_Khuiten\_Kharmagtai\_OP\_PFS\_Detailed Design File.dcf) contained several sets of pit designs with no explanations. It was assumed that the file (03.03.01.04.06 MP10729 Khuiten - Kharmagtai - Ultimate WH\_SH Pit Shellpt.dxf) that was provided separately contained the final pit design for the Stockwork Hill and White Hill. For the other areas, the layer '03 DESIGN\V8\MP STAGES' from Deswik was used for the review.

ERM also noted that some pit stage designs have sharp turns and discontinued ramps. Although this will not affect the financial result, the final pit designs will need to be improved at the next stage.

For personal use only

For personal use only

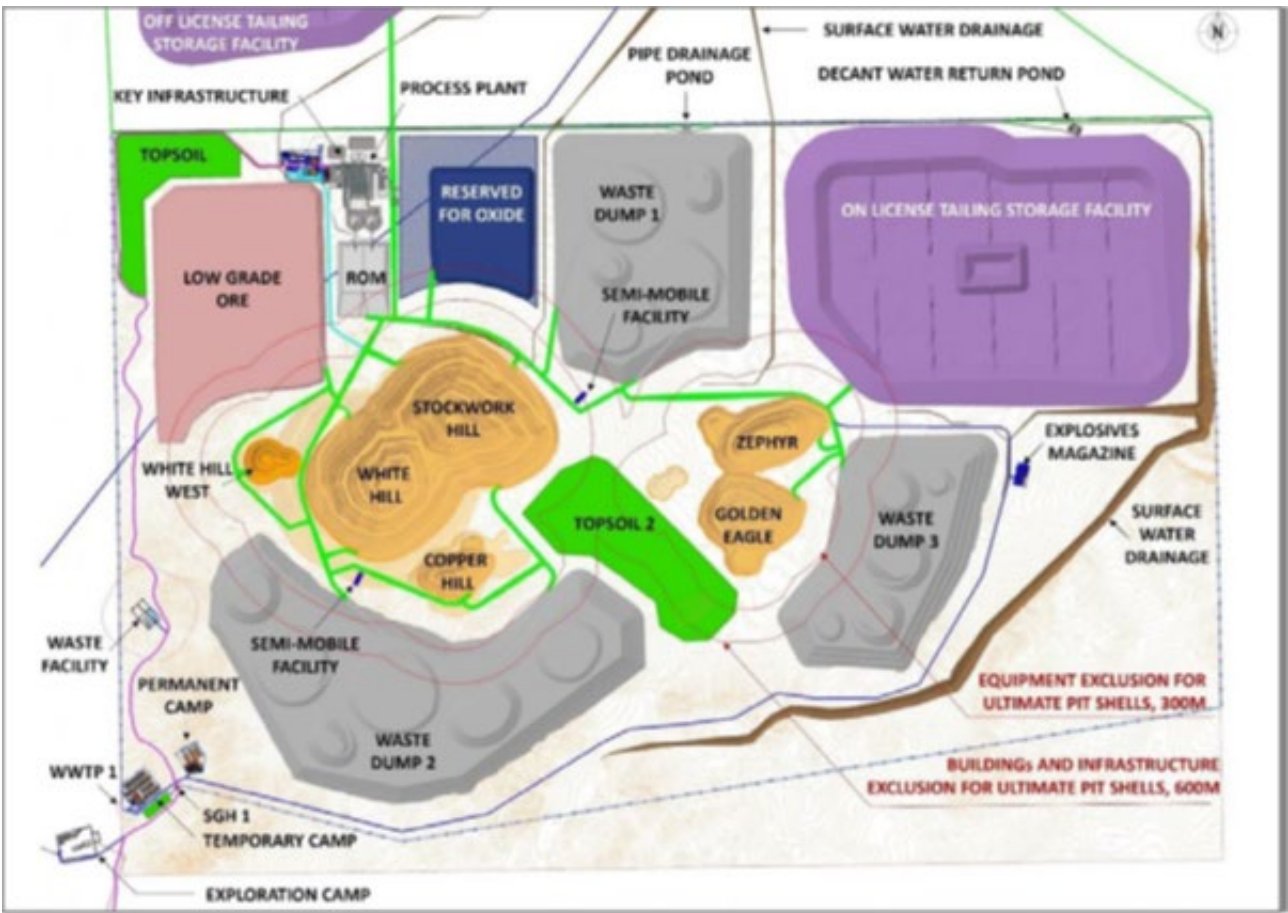

Figure 4-4: Kharmagtai proposed site layout.



Figure 4-5: Kharmagtai project overview looking north (Xanadu Mines Ltd, 2024e)

**PRODUCTION SCHEDULE**

Mine Scheduling was completed by Mining Plus using Deswik software. A base case schedule was developed that uses both Probable Ore Reserves and Inferred Mineral Resources within the open pit designs developed for the project (Figure 4-6). A marginal copper equivalent cut-off grade of 0.13% was used. Only fresh sulphide ore has been considered for processing. A small additional quantity of oxide material may be suitable for CIL gold recovery.

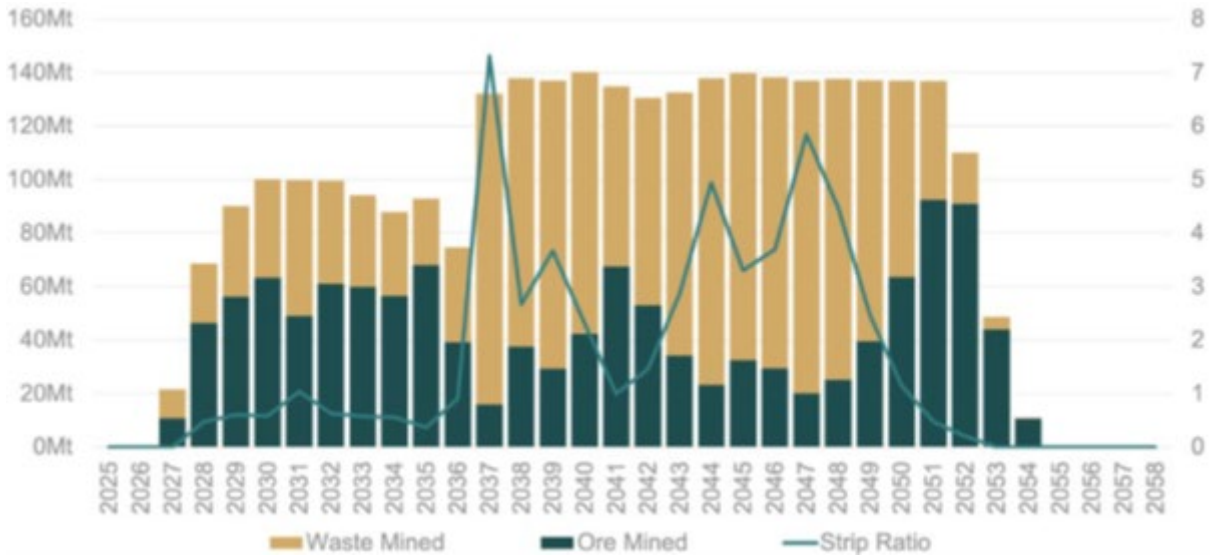

Figure 4-6: Annual production schedule (Probable Ore Reserves plus Inferred Mineral Resources)

A schedule utilising Ore Reserves only is summarised in Figure 4-7.

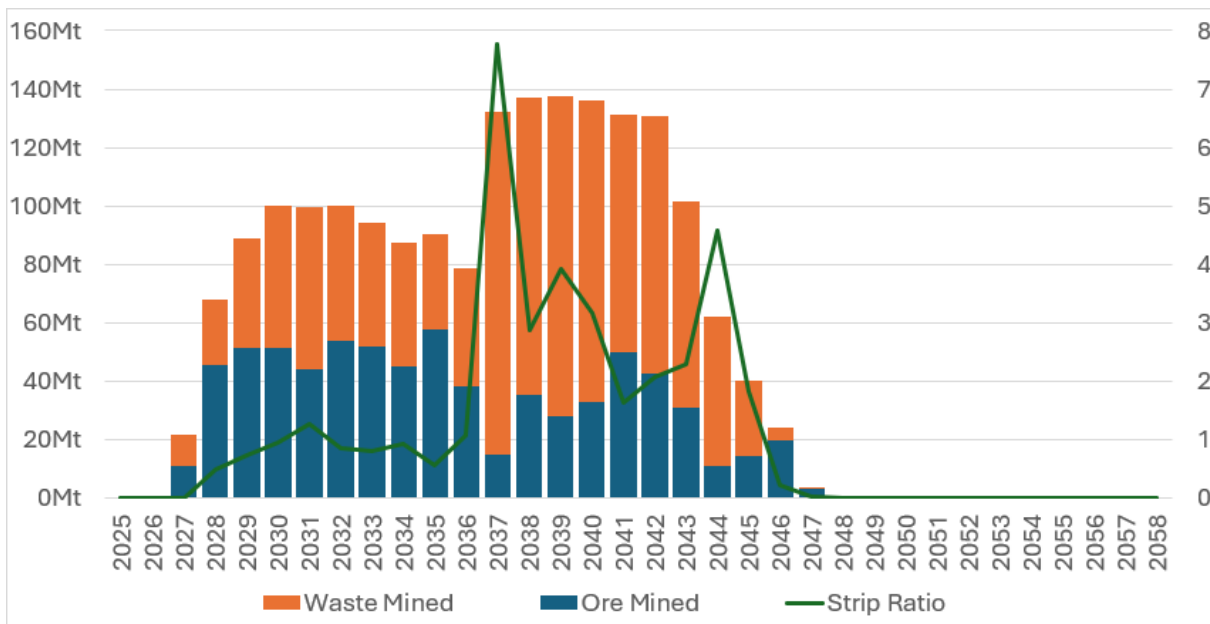

Figure 4-7: Annual production schedule based on Probable Ore Reserves only.

The vertical rate of advance was limited to ten benches per year, and the maximum annual mining rate peaked at 100-140 Mtpa. Depending on the open pit stage, the processing rate was 26-52 Mtpa.

A production schedule for the Kharmagtai project based entirely on Probable Ore Reserves is presented in Figure 4-7. Under a Probable Ore Reserves only case, the project's Ore Reserve is

For personal use only

exhausted in 2047, eight years earlier than the case in which Inferred Mineral Resource material is included in the production schedule. This highlights the potential upside present in further drilling to upgrade confidence in the project’s Mineral Resource Estimate, expand the project’s Ore Reserve and extend the life of the mine.

ERM believes that, for large, long-life mining operations like Kharmagtai, not establishing Ore Reserves for the complete life of mine should be considered to be acceptable. Ore Reserves must be estimated for the payback period of an operation and sufficient confidence established in the project’s Mineral Resource to provide an acceptable level of confidence that Mineral Resources will be able to be converted to Ore Reserves progressively, throughout the life of the mine and in advance of detailed mine plan development for the latter stages of mine development. This approach limits CAPEX on Ore Reserve definition, allows infill drilling required to be funded from revenue and by doing so, improves project economics when technical risk associated with this project is effectively managed.

The strip ratio is low in the first 9 years (around 0.65 tonnes of waste per tonne of ore) and the amount of Indicated material included in the proposed schedule is 88%. In Stage 2 of the plan (the remaining 21 years), the strip ratio increases to 1.9, and the amount of Indicated Mineral Resource included in the mine plan drops to 66%.

Stockpiling has been considered, and different elevated cut-off grades are used to high-grade the material during Stage 1 mining. Around 270Mt of material is stockpiled in the first 8 years before recovery of ore from stockpiles commences during Year 9 (Figure 4-8).

For personal use only



Figure 4-8: Movement of Ore to and from Stockpiles—Probable Ore Reserves and Inferred Mineral Resources model.

The version of the project’s financial model based on production using Ore Reserves relies on stockpiling up to 160 Mt of ore during the first six years of mining (Figure 4-9). This is less than for the Ore Reserves + Inferred Mineral Resources case but still significant.



For personal use only

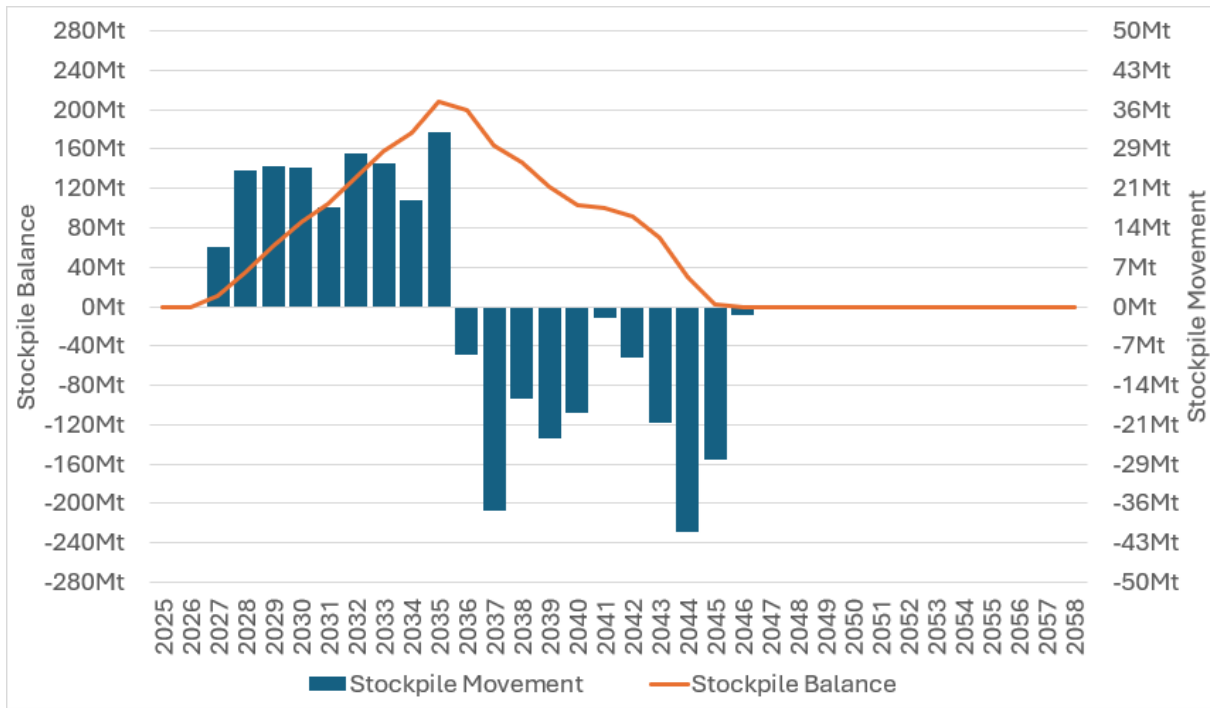

Figure 4-9: Movement of Ore to and from Stockpiles—Probable Ore Reserves only model.

ERM proposes that the project would benefit from implementing options to reduce reliance on stockpiles to maintain plant feed consistency and maintain metallurgical performance, through improved grade control and blending from multiple operating faces. Reliance on large ore stockpiles has an adverse impact on ore oxidation, metallurgical performance, operating costs and working capital requirements.

ERM has identified no other material issues with the proposed production schedule.

**EQUIPMENT**

The primary mining equipment selected is a 600-700 tonne hydraulic excavator, rope shovels and 290 tonne trucks. 32 m<sup>3</sup> wheel loaders will support shovels.

ERM is concerned that the large excavators (rope shovels) selected for the PFS will not be optimal for the 10m bench height used in the PFS pit design. The impact on costs and productivity of this decision is, however, likely to be relatively low (5%-10%). The impact on project valuation may not be material. An opportunity for improvement that could reduce operating costs and improve excavator productivity is considered by ERM to exist.

**WATER**

The South Gobi region has significant potential water resources that could meet all known demand including Kharmagtai projections. These lie in deep aquifers that form non-potable water sources. A large portion of these resources are not yet claimed, and there are also third parties who hold resources but are not utilising them. The identification of water sources for the Kharmagtai project has examined both new and third-party water sources.

Kharmagtai requires approximately 350l/s make-up water supply for Stage 1, which is roughly doubled for Stage 2 (Xanadu Mines Ltd, 2024f).



The Stage 1 water supply is expected to be sourced from deep aquifers in multiple basins near the project. Stage 1 water will be pumped to site via pipelines, with raw water used for ore processing and a water purification plant to provide potable water.

Stage 2 requirements are anticipated to be met through additional water exploration.

XAM completed a hydrogeological drilling programme as part of the PFS. Drilling identified a large aquifer in the vicinity of the proposed mine which will be further evaluated during 2025 to determine its ability to meet project Stage 1 and Stage 2 water requirements. This work will include drilling and pump testing to provide information required to establish groundwater reserves, lodge extraction permit applications and information needed to engage with existing water licence holders in the region.

Risk mitigation for both Stage 1 and Stage 2 requirements will come from the Mongolian government's Kerlen-Toono project (Blue Horse Water Infrastructure Programme) which aims to bring a high-capacity water pipeline from the Kherlen River in northern Mongolia to the Gobi within 6-8 years. The Kherlen Toono project is already in Feasibility Study stage and is designed to support the mining industry in the Gobi region. The project has been identified in a resolution of the Mongolian Parliament to approve the Cabinet's 2024-2028 Action Programme which identified 15 nation-building projects (Xanadu Mines Ltd, 2024f).

### GEOTECHNICAL STUDIES

Geotechnical studies are essential, especially for large open pit operations where maintaining pit wall stability is essential but maximising overall slope angles contributes to reduced strip ratios, the ability to safely place waste rock stockpiles close to the pit rim and lower, overall mining costs. Studies included evaluation of geological, structural and alteration mineral assemblages, material strength, in-situ stress estimation and rock mass classification from 48 specifically drilled geotechnical drill holes. The geotechnical data was analysed and used to undertake bench configuration design. The resultant design was tested for overall slope stability using 3D finite element modelling.

ERM endorses this approach. Collection of basic geotechnical data from all cored drill holes would enhance prediction of variations in rock mass characteristics (e.g. rock quality designation (RQD) and qualitative rock strength characteristics) across the deposit with increased confidence.

ERM considers these estimates low, particularly for a contract mining operation, but they may be achievable. The estimate used was developed by Mining One and validated independently by a Mongolia-based mining contractor. ERM proposes obtaining two or more contractor quotes to support and better inform operating cost estimates used in the project's Feasibility Study but accepts the current estimates for prefeasibility purposes.

### CLOSURE COSTS

Closure costs of US\$106 M is considered in the current financial model. ERM considers this appropriate. Closure costs will, however, require closer consideration in the project's Feasibility Study.

For personal use only

## 5. ORE PROCESSING AND BENEFICIATION—KHARMAGTAI PROJECT

### 5.1 OVERVIEW

The Kharmagtai project is the only one of XAM's three projects in Mongolia with metallurgical testing and development with an associated processing flow sheet. These have been developed within a 2022 Scoping Study and 2024 PFS.

This review is based primarily on the PFS documentation which describes significant developments in metallurgy and processing and contains the most up to date outcomes.

The key documentation used in this review includes:

- PFS Metallurgy Chapter, 02M2301-ADM-PFS-09 A, Metallurgy Rev D
- PFS Processing Chapter, 02M2301-ADM-PFS-09 B, Processing (Including CIL) Rev C
- Appendix 9A-B Final Kharmagtai Metallurgical Test work report Rev4
- Appendix 9A-E ALS Met Report Stage1—A25165 Final Rev1
- Appendix 9A-H2 Part A and Part B, Thickener Report
- Appendix 9A-C Final SMC Report for Kharmagtai project
- Appendix 9B-A1 Comminution
- Kharmagtai PFS Fin Model V10 Base Case15-Project\_reviews\_SCV10A

#### 5.1.1 METALLURGICAL TESTING OVERVIEW - SULPHIDE

The metallurgical test work conducted both by XAM and previous owners has been quite extensive over the period of development from 2008 to 2024. The many ore types identified have been observed to be represented over the years of development.

In particular the 2023-2024 programme showed a good representation of the various ore types with further breakdown into alteration, sulphide speciation and rock type.

The majority of the discussion presented will focus on the 2023-24 work due to its scope, detail and volume in comparison to previous work. A consistent metallurgical test workflow sheet as shown below was utilised through the bulk of the testing. This represents a primary grind of 150µm followed 3-stage flotation progressive copper cleaning circuit that incorporates a regrind of the rougher concentrate at 20µm.

Some 102 composites were selected for this (2023-2024 programme) volume of work representing the following sulphide deposits:

- White Hill, 42 composites.
- Stockwork Hill, 46 composites.
- Copper Hill, 10 composites.
- Golden Eagle, 2 composites.
- Zephyr, 2 composites.

For personal use only

- A breakdown of the expected feed proportions in the flotation concentration pathway is shown below in Figure 5-1. A breakdown of the plant feed in the financial model is discussed in later sections (Section 5.3).

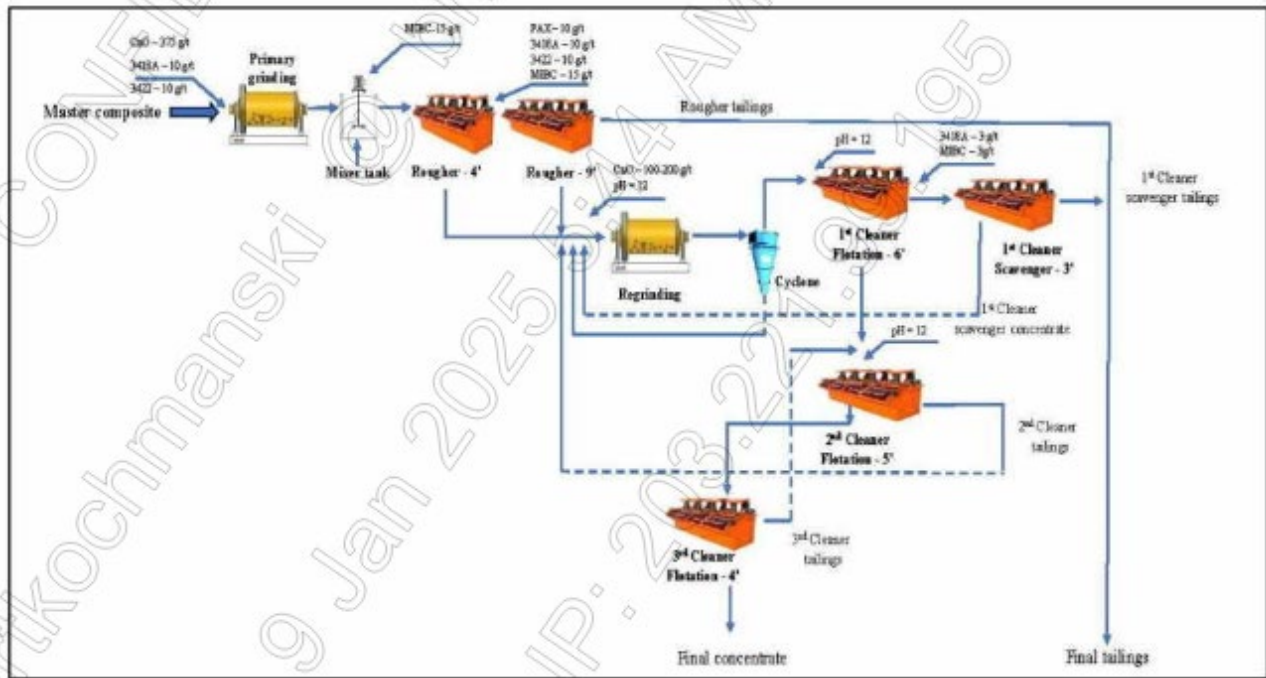

Figure 5-1: Metallurgical Test workflow sheet.

This programme consisted of comminution test work (bond ball and rod work index), gravity and flotation. This incorporated flow sheet development on a master composite (2kg from every sample), that appears above resource average grade (0.43% Cu, 0.63g/t Au, 2.53g/t Ag, 5.5% Fe, 2.11% S) along with locked cycle testing. In addition, baseline rougher flotation and gravity testing on 102 composites across the different orebodies was undertaken with further locked cycle testing. This is the True Technological Research Centre (TTRC) scope of work.

*"From this original 102 composites and reserves of the TTRC master composites, 30 composites were selected and used in further flotation (with a new master composite generated), followed by gravity and comminution work at ALS. The flotation work here also involved parametric (grind size, pH, reagent dosages) variability work as well as locked cycle work on the new master composite."*

### 5.1.2 COMMINUTION TESTING

The volume of comminution testing in the 2023-2024 programme is substantial in this programme alone. A brief summary of this is.

- 102 x Bond Ball work Index across Copper Hill, White Hill, Stock Hill, Golden Eagle, Zephyr
- 30 Crushing work indices across Copper Hill, Stockwork Hill and White Hill
- 30 x SMC tests across Copper Hill, Stockwork Hill and White Hill
- 30 x Abrasion tests across Copper Hill, Stockwork Hill and White Hill
- 30 x Bond Rod Work Indices across Copper Hill, Stockwork Hill and White Hill

- 30 x Bond Ball Work Indices across Copper Hill, Stockwork Hill and White Hill

There is a large and defined dataset allowing for a confident comminution design for a PFS design. Further detailed studies (definitive or bankable feasibility studies) may require additional SMC due to size of the project and breadth of the orebody (contained tonnes), but this is outside of the present scope of this review.

### 5.1.3 FLOTATION TESTING

In respect to PFS study, there were two master composites generated from 102 composites generated which forms the baseline for much of the development work in the PFS test work programme. A summary of the comparison between the composition from multiple ore sources is shown in Table 5-1 (below).

Table 5-1: Flotation Testing Summary

Prospect	Master Composite TTRC <sup>1</sup>	Master Comp ALS <sup>4</sup>	PFS Met Basis <sup>2</sup>	LOM <sup>3</sup>	Stage1 <sup>3</sup>	Stage2 <sup>3</sup>
White Hill	41.2%	47.8%	68%	83.8%	93.6%	81.7%
Stockwork Hill	45.1%	43.4%	21%	11.1%	4.22%	12.9%
Copper Hill	9.8%	8.8%	1%	1.24%	2.21%	1.03%
Golden Eagle	2.0%		6%	2.69%	0.00%	3.13%
Zephyr	2.0%		4%	1.10%	0.00%	1.28%

Source:

1. PFS Appendix 9A-B (Lord, Etheridge, Wilson, Hall, & Uttley, 2001)
2. PFS, Figure 9-1
3. Financial Model, Kharmagtai PFS Fin Model V10 Base Case 15\_Project\_reviews\_SCV10A
4. PFS Appendix 9A-E

While the PFS sets out the plant feed for the project, the ore schedule provided in the financial model shows a significant skew towards White Hill being principal ore source and economic basis of the project. This is a rather large discrepancy from 68% to ~80-90%, however, the metallurgy for the project will be discussed in the context of both scenarios (PFS met basis and the financial model being treated as separate realities) until clarified. Ultimately the bulk of the resource is represented by White Hill under both scenarios.

Locked cycle testing on the master composite was observed to obtain 80.45% Cu recovery with a grade of 23.28% and 70.46% at a 31.6 Au g/t Grade in the TTRC scope. Locked cycle testing would be considered the most representative of performance especially in respect to overall recovery. Potentially grade maybe understated as there are optimisations that are not practical in a laboratory setting dependant on the complexity of the flow sheet.

Locked cycle test work was further conducted at ALS on two composites. One was the reserve from the TTRC scope mentioned above and a newly generated master composite (generated from ~30 composites). Similar results were obtained on the TTRC reserve in the ALS testing, albeit a lower Au grade of 30 g/t. The ALS master composite was able to obtain a similar result of ~22% Cu with 86% recovery and 18.2g/t Au at a 73% recovery for gold.

For personal use only

Within the PFS documentation there is reference to locked cycle testing of individual ore body composites (Copper Hill, Stockwork Hill and White Hill). The test work log sheets / reports were not available for review making it difficult to confirm or assess the outcomes of this work. A summary in Table 5-2 (below) shows that, due to poor concentrate grades, the tests were conducted with cyanide dosage as depressant in the cleaner stage of the locked cycle to reject pyrite and ensure copper mineral separation.

Table 5-2: Locked cycle testing of deposit composites, PFS table 9-41

Prospect	Head Grade	Cleaner Con	Recovery
	% Cu	% Cu	% Cu
Copper Hill A*	0.33	18.3	82.9
Stockwork Hill A*	0.19	14.6	74.4
Stockwork Hill B	0.28	13.1	82.4
Stockwork Hill C*	0.35	20.9	82.9
White Hill A*	0.17	18.3	57.2
White Hill B*	0.27	16.7	78.8
White Hill C	0.33	17.1	80.4
White Hill B+C*	0.27	26.3	79

It is clear that lower concentrate copper grades were achieved when compared to that of the master composite, at comparable recoveries, from the locked cycle testing of individual deposits. The metallurgical performance achieved could be due to low head grades, high S:Cu or insufficient copper mineral liberation in the rougher flotation.

#### 5.1.4 FLOTATION VARIABILITY

Variability in the TTRC scope of work focused primarily on the rougher stage with flotation to the third cleaning stage determined in the ALS test work. A summary of the final concentrates from the ALS work can be seen in Table 5-3 (below).

Table 5-3: ALS Test work Final Concentrate Characteristics

Prospect	Copper Hill		Stockwork Hill		White Hill		Overall	
	Cu Grade (%)	Cu Recovery (%)	Cu Grade (%)	Cu Recovery (%)	Cu Grade (%)	Cu Recovery (%)	Cu Grade (%)	Cu Recovery (%)
Average	20.6	755.9	22.05	80.12	19.21	75.51	20.6	77.5
Maximum	32.7	78	33.22	92.37	27.12	82.3	33.2	92.4
Minimum	12.1	71.8	11.32	66.2	9.68	59.89	9.68	59.9
Count	3	3	11	11	12	12	26	26

A number of the lower final concentrate grades observed appear within White Hill.

Analysis within the reports highlights that a high S:Cu ratio, indicative in this current case of higher pyrite within the feed ( $\text{FeS}_2$ ), corresponding to a poor final concentrate grade. This is shown in the figure below (Figure 5-2).

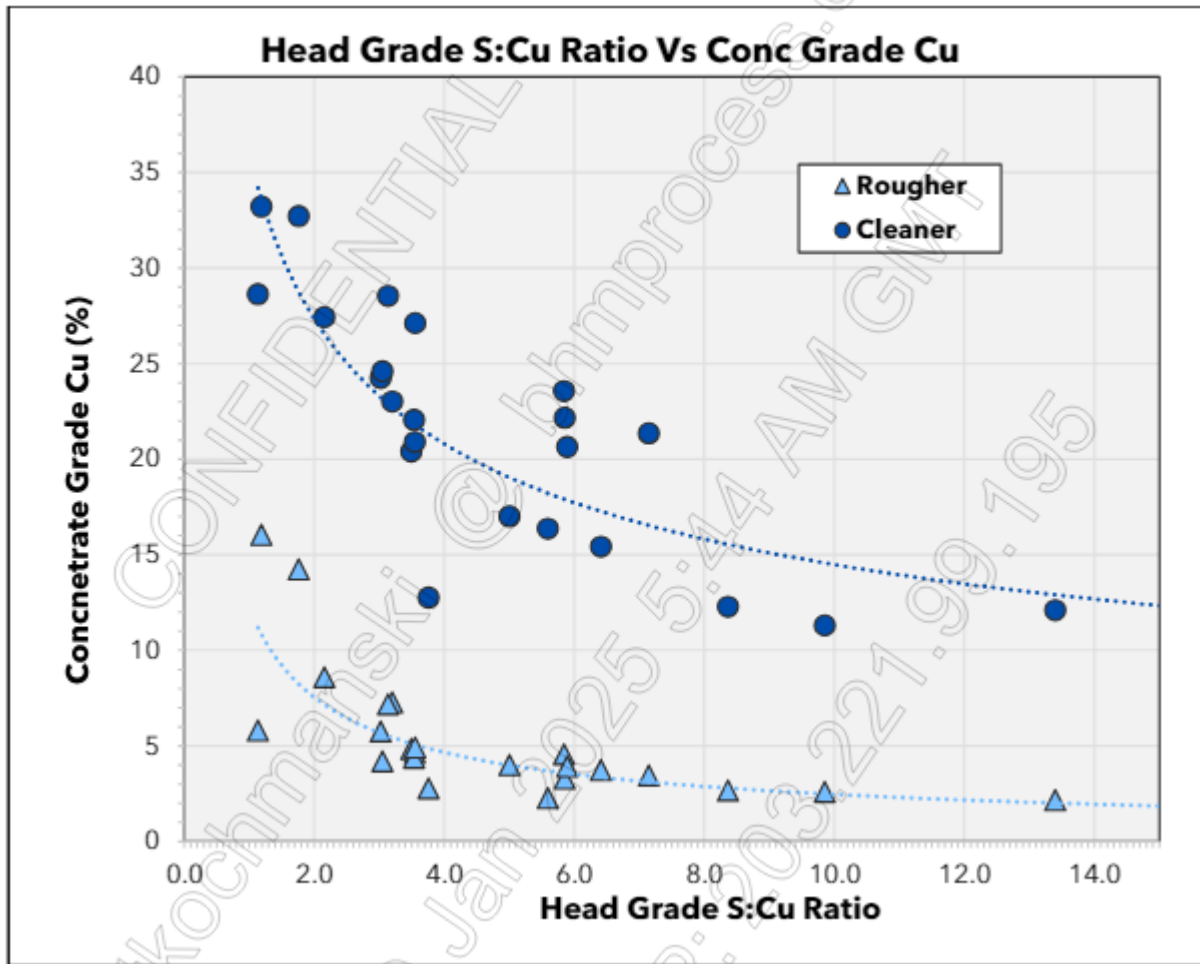

Figure 5-2: Final Concentrate grade vs Head S:Cu ratio, ALS report A25165

Typically this is addressed with either sufficient selectivity in the flotation stages with collectors utilised. The use of 3418A and 3422 are common strategies.

In case of pyrite depression sodium cyanide or other depressants can be added but this may also depress chalcopyrite causing lower recoveries. A depressant within the cleaning stage was added at a pH of 11 (F250) during parametric testing. This visibly reduces the Cu recovery.

As discussed in the section above, in regard to cyanide in the locked cycle, this appears to have had some limited success within the cleaning circuit to increase the product copper grade, however, this is also associated with a reduction in Cu recovery.

An attempt at pyrite depression during the roughing stages was not observed in the test work.

### 5.1.5 MINERALOGY

Mineralogical analysis (QEMSEM) was conducted on the flotation feed for the master composite and then on generated samples of cleaner feed concentrate and tailings in the PFS programme. Of note is that predominately the Cu is present as chalcopyrite and that the bulk of pyrite present in the particular sample, was relatively high (~18% in an unliberated state) with only

11% reporting to the final concentrate. That particular third cleaner concentrate achieved a ~22% Cu grade.

Samples of poor performance (that did not achieve grade) did not have mineralogy conducted so ascertaining if the issues in the high S:Cu head samples is a case of high pyrite content not being rejected in the cleaning circuit due to volume of pyrite or finer grind size (i.e. not liberated) could not be concluded.

### 5.1.6 COARSE ORE FLOTATION

Coarse ore flotation testing (crossflow and hydrofloat) has been conducted during the PFS programme but has yet to be incorporated in the current processing flow sheet.

A separate master composite (58% White Hill, 42% Stockwork Hill) was prepared for this work.

### 5.1.7 JAMESON TESTWORK

The composite generated for the coarse ore flotation work was tested via an industry standard methodology to assess the potential amenability of the Jameson cell before piloting work is considered. A positive result was observed that may indicate an ability to deal with high pyrite feed (high S:Cu ratio in the head) (Table 5-4).

Table 5-4: Jameson Comparison, ALS Report A25165

LOM Master Composite 250 µm CPF Product—Flow sheet Comparison Grind Size P <sub>80</sub> : 75 µm / Re grind P <sub>80</sub> : 18 µm											
Test	Flow sheet	Calculated Head			Third Cleaner Con (Final)						
		Cu %	Au g/t	S <sub>total</sub> %	Mass %	Cu		Au		S <sub>total</sub>	
						Grade %	Rec %	Grade %	Rec %	Grade %	Rec %
JS5897	Baseline Conventional	0.63	0.58	2.98	1.76	23.5	66.0	11.2	34.1	38.4	22.7
JS5909 + JS5959	Rougher + Dilution Cleaner	0.71	0.63	3.19	1.50	30.6	64.9	22.6	54.0	33.8	15.9

### 5.1.8 GRAVITY TESTWORK

Gravity testing was conducted across all the variability samples and while the results are variable, the amount gravity gold appears fine grained and likely in the <20% range.

### 5.1.9 FILTRATION AND THICKENING TESTING

No filtration testing of concentrates was observed. Dynamic thickening test work on the rougher tailings of the master composite was conducted.

### 5.1.10 CONCLUSIONS AND DISCUSSION

The test work conducted, and metallurgical knowledge observed around the project is of a high standard for this stage of study.



The flotation response has been established under a base case flow sheet and though there is some significant variability observed, there is an understanding of where this needs to be tackled.

There are areas that will need further detailed definition around process engineering (i.e. jar test for regrind mill, thickening tests and filtration tests for the concentrate), but this detail is typically addressed in the Feasibility Study.

The ability to be able to deal with high pyrite feed (S%/Cu% of >6) will need to be addressed and rectified dependant on the ore processing schedule and / or ability to blend these zones down.

## 5.2 METALLURGICAL TESTWORK—OXIDE ORE/LEACHING SULPHIDE TAILINGS

Metallurgical test work on treating the oxide components of the orebody and tailings stream from the sulphide flotation plant has focused around predominately Au recovery.

Various tests ranging from coarse bottle rolls and column leaching (looking at heap leaching) with acid and a glycol/cyanide mixture has been investigated along with lixivants (leach reagents) in an agitated leach resembling the standard CIL typical in gold processing.

Recoveries have been observed to be variable with ~60% observed on the cleaner tails from the sulphide ore derived from the master composite from the ALS programme, to achieve recoveries in the range of 50-70% in agitated leaches with a cyanide/glycol mixture.

## 5.3 PROCESSING

### 5.3.1 PFS STUDY DESIGN

The 2024 PFS study design incorporated a two-stage approach of 24 MTPA per stage. The flow sheet can be seen below with a conventional primary crushing circuit followed by a semiautogenous and ball mill comminution circuit.

Stage 1 has a single train of crushing, following by two trains of semiautogenous grinding (SAG) mills and ball mills into a single flotation train. Gravity concentrators on the cyclone underflow of the ball mills generate a gold concentrate for smelting in the gold room. The grinding circuit product proceeds to the flotation circuit which is a rougher circuit with three stages of cleaning post regrind with a cleaner / scavenger incorporated.

This is duplicated in Stage 2 effectively doubling the plant throughput for a total of 52 MTPA. A combined concentrate thickener is used for both stages with duplicate filtration system for the Stage 2. A single tailings thickener is used per stage for discharge into a tailings dam. This is shown below in Figure 5-3. This process flow sheet is representative and suitable in respect to the test work conducted.

For personal use only

For personal use only

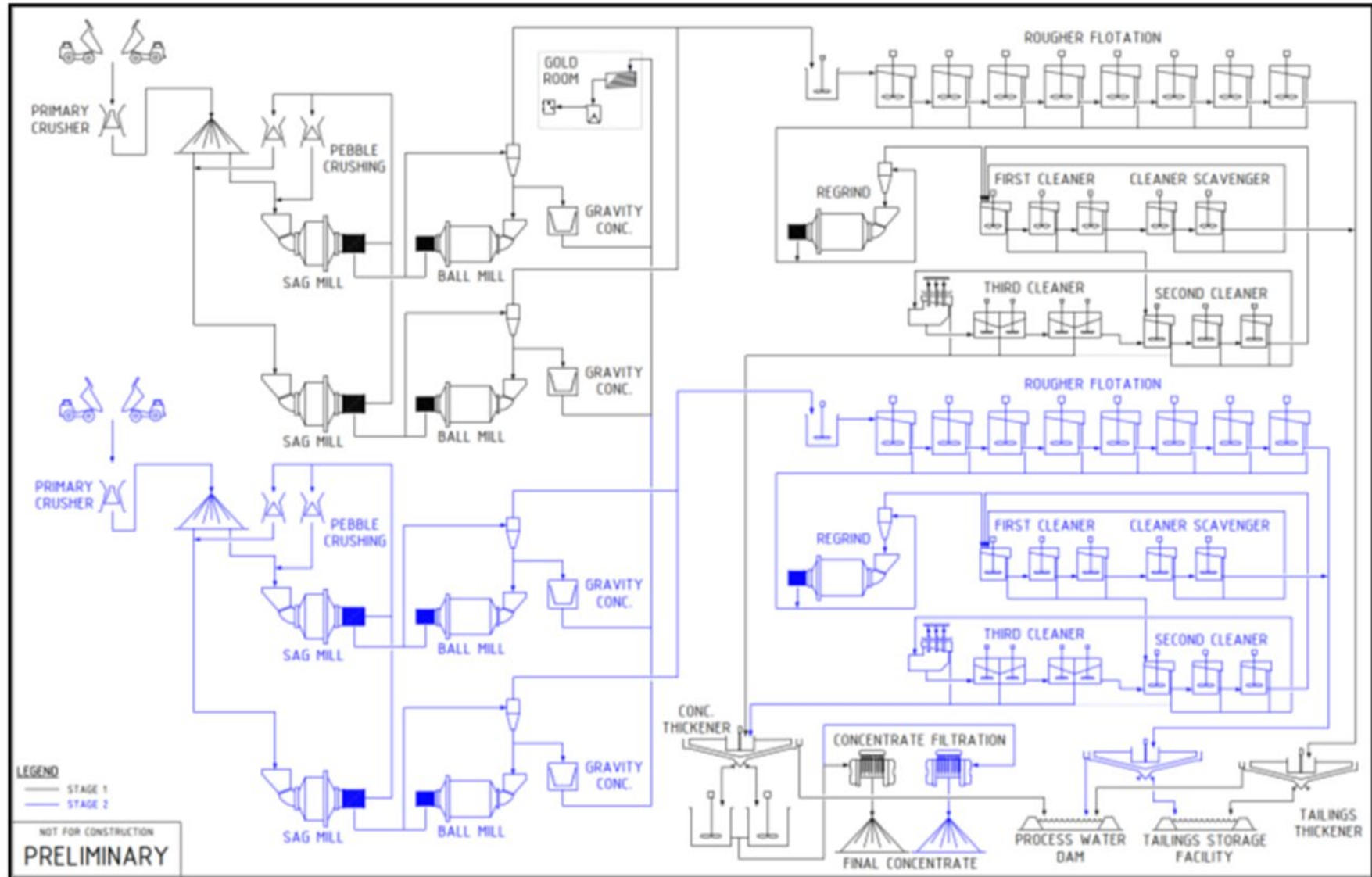

Figure 5-3: Stage 1 and 2 Process Flow sheet. 2024 PFS, Chapter 9, pg12. Stage 2 (Blue)



Higher copper recoveries with a lower copper head grade were used as the design basis (85% Cu recovery to a 20% Cu concentrate grade). This gives some additional contingency for interstage equipment (hoppers, pumps etc.) to ensure the processing facility is not under sized and can manage feed variation, mass flow etc.

A number of studies (comminution, coarse ore flotation, regrind) studies were observed in the PFS along with clear design basis for each of the individual sections of the process plant.

The design basis for unit operations reflects the metallurgical test work conducted. Where there has not been sufficient material to conduct testing (regrind, concentrate thickening, concentrate filtration) reasonable and conservative figures have been utilised.

### 5.3.2 CIL OPERATION

A CIL plant utilising cyanide is planned to treat 0.5mtpa of oxide ore (crush, grind, leach) and 1.5MTPA of the cleaner tails from the Stage 1 (26MTPA) sulphide concentrator. As no SMC data was available the 0.5MTPA uses a three-stage crush and ball mill (Ball bond work index data available). This is a prudent decision.

Leach test work on a CIL process has been observed on the cleaner tailings. Oxide material has also been observed in the PFS documentation (metallurgy and processing chapter). However, the cyanide basis in the processing section is not present in the metallurgy chapter and the test work reports for both chapters were not able to be reviewed at this time. In terms of the samples source, representativity and test work outcomes this leaves ¼ of the CIL design basis difficult to confirm.

### 5.3.3 OPEX—FLOTATION CONCENTRATOR

A summary of the estimated OPEX is presented in Table 5-5 below.

Table 5-5: OPEX Summary, PFS 2024 Chapter 9 Table 9-36

	Stage 1			Stage 2		
	\$US/a	\$US/t Plant Feed	\$US/lb Cu	\$US/a	\$US/t Plant Feed	\$US/lb Cu
Labour	3.08	0.12	0.02	4.1	0.08	0.02
Power	60.16	2.31	0.4	118.52	2.28	0.51
Maintenance Material	12.73	0.49	0.08	234.84	0.48	0.11
Reagents and Consumable	57.33	2.21	0.38	114.62	2.2	0.5
Miscellaneous	2.66	0.1	0.02	3	0.06	0.01
<b>Total</b>	<b>135.96</b>	<b>5.23</b>	<b>0.9</b>	<b>265.08</b>	<b>5.1</b>	<b>1.15</b>

Overall operating figures of \$US5.23/t and \$US5.14/t for phase 1 and phase 2. These are relatively low operating cost figures for a flow sheet of this complexity.

The general philosophy and methodology of the documented estimate is in line with industry standards.

As can be seen, the bulk of the associated costs are around power (predominately crushing and grinding) and reagents.

#### 5.3.4 LABOUR

A summary of the labour estimate is presented in Table 5-6 below.

Table 5-6: Metallurgy and Processing Labour Requirements

	Stage 1	Stage 2
<b>Operations</b>		
Plant Management	3	3
Technical Services	9	11
Processing	62	106
Gold Room	4	4
Laboratory	43	55
Subtotal - Operations	121	179
<b>Maintenance</b>		
Maintenance Management	3	3
Planning	6	7
Mechanical	42	60
Electrical	22	30
Instrumentation	7	9
Subtotal Maintenance	80	109
<b>TOTAL</b>	<b>201</b>	<b>288</b>

ERM find that the manning estimates are in line with expectations of an operation of this size and complexity with experienced operators. It is noted in the PFS that the salary figures are based on in-country labour. It would expect that if the local workforce were not sufficiently experienced an equivalent Australian based workforce would be expected to cost in the order of 3-4 times greater than presented here. With the labours costs contributed ~2.3% of the current operating costs this is relatively insignificant.

#### 5.3.5 POWER

Power was estimated based of the installed equipment and the average daily power draw with an in-country power cost of \$US 0.08/ kWh. This is a sufficient basis for this level of study.

#### 5.3.6 REAGENTS AND CONSUMABLES

Reagent figures were calculated based off test work results and are consistent.

Consumables for the crushing, grinding and filters were calculated, and the unit numbers are in line with industry expectations.

### 5.3.7 MAINTENANCE MATERIALS

The maintenance cost of materials was estimated based off of factoring the direct capital cost against the process plant areas. This can be seen summarised below for stage 1. The same commentary applies to Stage 2 (Table 5-7).

Table 5-7: Maintenance Materials estimate Stage 1, Table 9-43

Area	Direct Costs US\$M	Factor (%)	Cost US\$/y ('000)
Primary Crushing	32.7	3.5	1,144
Stockpile Reclaim & Recycle	15.5	3.5	5411
Grinding	297.08	3.5	10,398
Gravity	3.6	3.5	128
Flotation	97.9	3.5	3,425
Concentrate Thickening & Handling	19.2	3.5	670
Tailings Thickening & Pumping to Storage	44.3	3.5	1,551
Reagents	15.4	3.5	541
Services			
Gold Room			
Offices & Control Room			
Workshop			
Process Plant Boiler House	22.8	1.00	228
Ancillary Buildings Heating Plant			
Decant System			
Laboratory			
Chemical Warehouse			
<b>Total</b>	<b>548.5</b>	<b>3.40</b>	<b>18,626</b>

Some of the factors appear lower than expected, for example crushing and grinding are typically around 7% and 5%. The overall impact of this is well within the stated +/-30% accuracy with the maintenance materials costs contributing ~10% to the OPEX.

### 5.3.8 MISCELLANEOUS

The miscellaneous costs cover laboratory and mobile equipment costs. These have been accounted for and are within expectations.

CIL components have also been incorporated with a 64% Au recovery applied to the sulphide plant cleaner tails and 88% Au for the oxide component. This is reasonable on the basis of the recoveries generated from the met testing conducted to date (stated oxide recoveries unverified vs raw test work data).

ERM is satisfied with the process design, test work completed for the project and both processing CAPEX and OPEX estimates detailed in the project's PFS.

## 5.4 SMELTING AND REFINING COSTS

Smelting and refining costs represent the outcomes of commercial negotiations between miners and smelters that miners have only limited ability to influence. Smelting and refining contract terms negotiated between miners and smelters are influenced by market conditions, logistics and smelting costs which include sustainable management of waste materials produced during the smelting and refining process which may influence the relative attractiveness of concentrates produced by individual mines.

The smelting and refining included in the Kharmagtai financial model are considered by ERM to be generally consistent with terms currently being offered by smelters in China and other Asian countries to which Kharmagtai concentrates could be viably shipped. This is influenced by the modes of transport used for concentrates with corresponding transport costs, in addition to differences between royalty rates levied on concentrates to be processed locally rather than exported.

For personal use only

## 6. PROJECT FINANCIAL MODEL REVIEW

### 6.1 FINANCIAL MODEL INPUTS

ERM has reviewed the mining and processing capital, and operating cost estimates used in the Kharmagtai project financial models prepared in conjunction with the project's PFS.

#### 6.1.1 FINANCIAL MODELS

Several financial models were provided for review.

The financial model (03.03.01.02.02 Kharmagtai PFS Model (Simplified Version).xlsx) considers both Ore Reserves and Inferred Mineral Resource material (27%). An Ore Reserves only case financial model (03.03.01.02.03 Kharmagtai PFS Model (Reserves Only).xlsx) was also provided. Aspects of both models have been discussed in the Mining section of this report, particularly in relation to the proposed production schedule and movement of ore to and from stockpiles throughout the life of the mine (above).

#### 6.1.2 CAPITAL EXPENDITURE

Mining, pre-production capital expenditure, and sustaining capital have been included in the project financial model (03.03.01.02.02 Kharmagtai PFS Model (Simplified Version)) by including them in mining contractor costs presented in the model. A mining contractor reviewed this approach in preparation of the project's PFS and considered it reasonable.

Even with the use of contract mining, the owner will still have initial mining capital expenditure requirements including HME and light vehicle workshops, equipment mobilisation, electrical infrastructure and connections, storage facilities, offices, accommodation village etc., which may vary slightly according to the nature of the mining contract ultimately negotiated for the project.

The project's initial CAPEX estimate is significantly lower than that for comparable projects in central Asia, which required at least double the CAPEX proposed for Kharmagtai. Similar-sized projects that were commissioned both in Mongolia and in nearby countries required CAPEX exceeding US\$2 billion. Examples include Oyu Tolgoi (CAPEX of US\$2.3 B in 2012 for development of an open pit, concentrator and project infrastructure), Bozshakol in Kazakhstan (US\$2.3 B in 2015), and Aktogay in Kazakhstan (US\$2.1B in 2016).

ERM discussed this with Mining Plus Pty Ltd (Mining Plus) and O2 Mining Limited (O2), the companies responsible for the Kharmagtai PFS and was convinced that the process followed in estimating the capital cost for the project was reasonable, robust and adequately reviewed during PFS preparation, even though comparable transactions suggest that the cost estimate is unusually low.

The apparently low capital cost estimate for the project was examined further by ERM through referring to online commercial information services for mining projects in central Asia, ERM's experience in the region and direct discussions with Mining Plus and O2 personnel directly involved in preparation of the project's PFS (Xanadu Mines Ltd, 2024f).

Mining Plus sought heavy mining equipment (HME) quotations from agents for both Komatsu and Caterpillar in Mongolia and from several Chinese HME manufacturers. One Chinese manufacturer and the Komatsu agent in Mongolia responded. The Komatsu proposal was the most detailed and included information regarding servicing costs and spares availability in

For personal use only

Mongolia, which enabled Mining One to develop a detailed HME cost estimate for an owner-operated operation. This enabled a contract mining estimate to be developed by spreading the HME expenditure over several years with no allowance for a contractor margin, assuming the contractor would achieve a margin through attractive equipment pricing and greater efficiencies than could be achieved by an owner-operator. ERM is familiar with and supports this approach.

The cost of Chinese equipment was considerably lower than for comparable Komatsu equipment but the level of information relating to service life, maintenance and spares requirements was lower. Mining Plus concluded that it was likely that there would be little or no overall cost of ownership benefit from using Chinese equipment and elected to base their analysis on the information provided by Komatsu.

Mining One further requested a contract mining estimate from Thiess Mongolia LLC who are the largest mining contractor in Mongolia and have been operating in the country for 18 years. Thiess, in their response, provided cost estimates for Caterpillar equipment in Mongolia. Thiess are one of the largest users of Caterpillar equipment globally. Thiess concluded that the estimate developed by Mining One was reasonable for a project in Mongolia.

ERM was also concerned that sufficient expenditure had been allowed for the development of required infrastructure, able to permit year-round operations at the Kharmagtai site. The site facilities were designed and costed by O2's in-country team to meet all Mongolian building regulations and requirements and make use of locally available building materials and labour. Particular attention was directed towards the design of HME maintenance facilities which have been designed to allow maintenance and repairs to be conducted year-round in both very hot and very cold conditions.

Power for the site will be sourced from the existing, local electricity network that is connected to the Chinese electricity grid. An adequate water allowance has also been secured for the proposed mine.

ERM considers the approaches followed by Mining Plus and O2 to represent sound industry practice as presented in both the PFS and subsequent meetings that would deliver estimates meeting Prefeasibility Study standards. The difference between the estimates prepared for the project and estimates for comparable projects in both Mongolia and surrounding countries remain, but ERM considers reliance on the Mining One and O2 estimates provided for the project to be justifiable in light of the described rigour and use of local experience in preparing them.

Capital cost estimates, and the staging of pre-development expenditure are detailed in the project's financial model prepared for the PFS (Xanadu Mines Ltd, 2024f).

### 6.1.3 PROCESSING CAPITAL EXPENDITURE

CAPEX figures were developed by the engineering firm DRA Global Limited (DRA) based on the design as discussed in the sections above. The CAPEX was prepared utilising a combination of budget quotations, database quotation and factors applied by the engineering firms from their database on similar projects (DRA). The methodology and volume of comparable quotation indicate that there should be high confidence in the figures provided (within the +/- 25% stated). A heating and ventilation system (HVAC) appears to also have been incorporated given the climate of the region the project is located.



Metallurgical plant construction direct costs outside of equipment costs appear to be lower than those observed in western countries, which is interpreted by ERM to reflect lower labour rates for construction.

The estimated capital cost of the 2 Mtpa CIL plant proposed for the project included in the financial model is considered reasonable for a plant that only needs to grind 0.5 Mtpa of ore.

#### 6.1.4 OPERATING COSTS

The project's financial model (03.03.01.02.02 Kharmagtai PFS Model (Simplified Version)) includes all-in operating costs that vary throughout the life of the mine between US\$1.55 and US\$3.33 per pound, with an average of US\$1.90/pound. The corresponding C1 cash cost of mining varies between US\$0.70 per pound and US\$1.50 per pound, with an average of US\$1.30 per pound LOM. This corresponds with a mining cost per tonne of ore between US\$11.50 and US\$16.80 per tonne of ore, with an average of US\$12.50 LOM. By comparison, the C1 cash cost of open pit mining at Oyu Tolgoi was US\$1.37 to US\$1.59 per estimated, which is slightly higher but in ERM's opinion, comparable with estimated Kharmagtai C1 cash costs (MDO, 2025).

ERM considers the estimated operating costs for the project to be reasonable, based on the process by which they have been estimated and comparison with comparable projects in Mongolia.

An overall operating cost of \$12.5/t is relatively low for a gold CIL operation is smaller than expected. This is, however, accounted for by the plant receiving 1.5 Mtpa of already ground feed from the flotation plant in the 2 Mtpa of ore planned for CIL processing annually.

#### 6.1.5 FINANCIAL MODEL METALLURGICAL INPUTS

The financial model has been developed using a yearly schedule. Mine to stockpile, Mine to plant and stockpile to plant have been incorporated. A yearly schedule is considered adequate for a PFS assessment of the financial state of the project.

This does not allow for the inference of the blending strategy into the processing facility and whether this will have a substantial impact. The bulk of the mass being processed is mined from the White Hill orebody (68%).

A summary of the ore schedule derived from the financial model is presented in Figure 6-1 (below). The sequence of mining of each of the orebodies is difficult to track in the financial model.

Broadly speaking the variability testing conducted (74 cleaner tests and seven locked cycle tests) were broken down into material types as BAK (background), POT (potassic), SER (sericitic) and TBX (tourmaline breccia). From these, the data was interpreted to give an overall estimate of recovery based on Cu and S:Cu head grade at a calculated concentrate grade (Table 6-1).

As mentioned, this is quite detailed and verification of the correct figures and application within the financial model is not possible in the current scope of this review. The methodology and intent are appropriate and noteworthy at this stage of study.

For personal use only

Table 6-1: Example of TBX Grade and Recovery estimates, PFS Metallurgy Chapter Table 9-92

TBX: Final Copper Recovery Estimates for a Range of S:Cu Ratios and Head Grades										
S:Cu Ratio	Cleaner Conc.	Head Grade %Cu								
		% Cu	0.10	0.15	0.20	0.25	0.30	0.35	0.40	0.45
2.5	28.2	81.5	82.6	83.9	85.0	86.0	86.8	87.4	88.0	88.5
5.0	23.0	81.8	82.8	84.1	85.3	86.2	87.0	87.7	88.3	88.8
7.5	20.0	81.8	82.9	84.3	85.5	86.5	87.3	88.0	88.6	89.1
10.0	17.9	81.9	83.0	84.5	85.7	86.7	87.5	88.2	88.8	89.4
12.5	16.2	81.9	83.2	84.6	85.9	86.9	87.7	88.5	89.1	89.6

As can be seen in Figure 6-1 the current ore schedule is continually above a S:Cu of six past 2033 (>Yr 5) with a significant drop in concentrate grade expected. This has been acknowledged within the documentation and further development and intention is that incorporation of the Jameson Cleaner, along with cyanide addition, will help rectify this with pyrite rejection (the dataset does not include the Jameson incorporated).

For the PFS, a proposed 25% Cu grade has been adopted for feed with S:Cu up to 7.5 and 22% for feeds with S:Cu greater than 7.5. The financial model has incorporated 23% for <7.5 and 20% for >7.5.

This appears to be an appropriate assumption at this stage of study but as stated within the documentation, further pilot scale testing is required to confirm this.

The various deposits have been incorporated into the financial model (Stockwork Hill, White Hill, Copper Hill, Golden Eagle, Zephyr, Wedge SH/WH, Zaara).

For personal use only

For personal use only

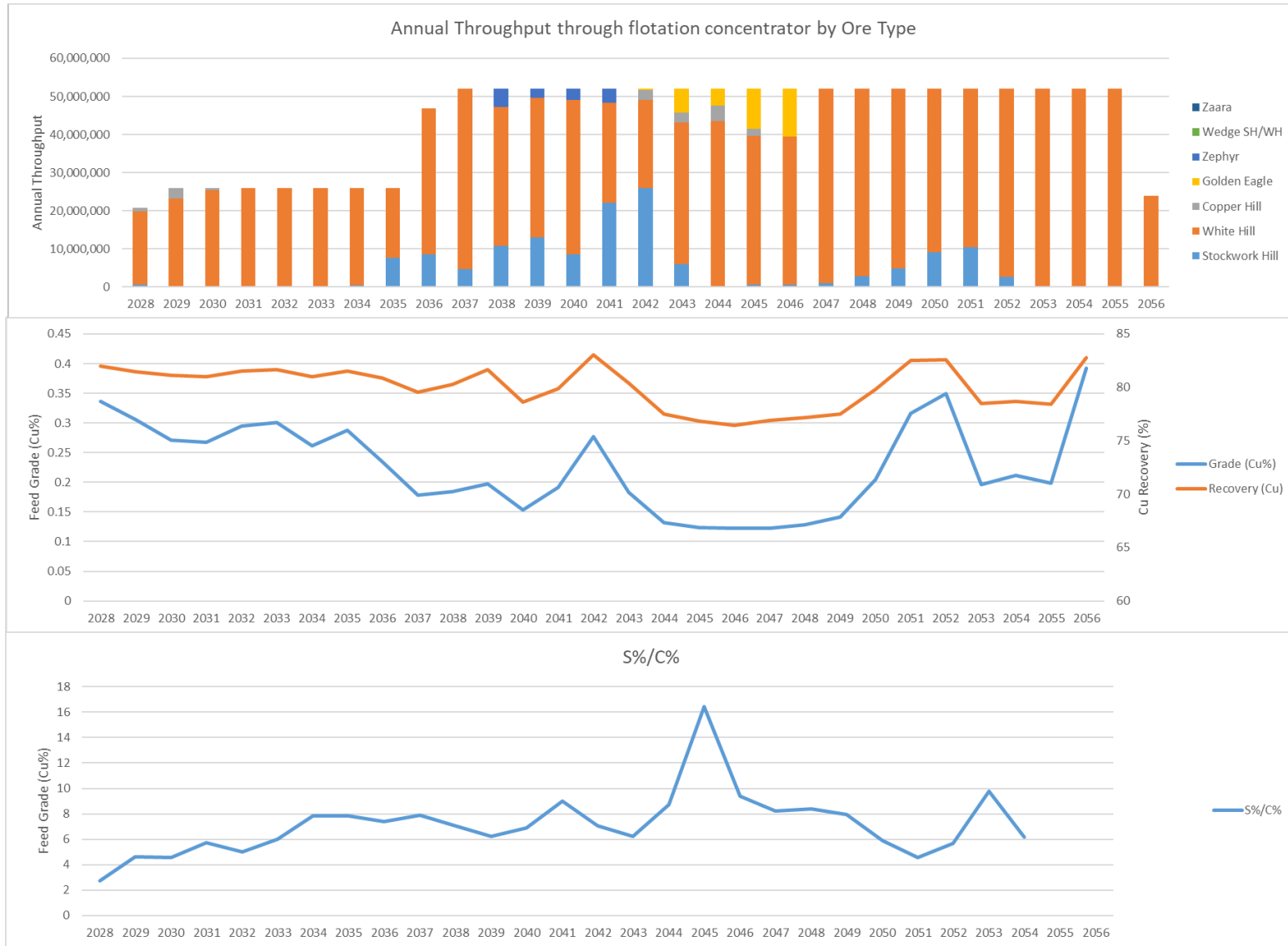

Figure 6-1: Ore Schedule Derived from Project PFS Financial Model



### 6.1.6 PROCESSING PLANT CAPITAL AND OPERATING COST DISCREPANCIES BETWEEN FINANCIAL MODELS AND PFS REPORT

Processing plant CAPEX and OPEX have been incorporated into the financial model. There are some minor variances between the PFS documentation and the financial model in terms of CAPEX and OPEX figures, (i.e. \$2.44/t for power in the model vs \$2.31/t in the documentation) but these are not considered by ERM to be material to the project's valuation.

### 6.1.7 ROYALTIES

Royalties have been assumed to be 8.36 per cent for Cu and 5 per cent for Au.

Royalty rates in Mongolia are linked to commodity prices. In the case of copper in concentrates, a 5 per cent royalty applies when copper prices are US\$5,000 per tonne or less. A 13 per cent royalty applies between US\$7,000 and US\$8000, and 20 per cent if the price exceeds US\$9,000 per tonne. Royalties are also levied on minor elements included in concentrates (Byambajav, 2021).

Royalty rates for copper used in the PFS are considered by ERM to be low. A rate of 20 per cent for copper should be considered with copper prices forecast to exceed US\$9,000 in the medium to long-term (Consensus Economics, 2025). The 5 per cent rate used for gold is supported by ERM.

ERM raised the question of royalties with XAM. The 20% royalty rate is applicable to copper at current and forecast prices, but companies have an ability to negotiate royalty rates in establishing investment agreements for major projects. Rio Tinto's Oyu Tolgoi mine, for example, negotiated a copper royalty of 5% for that mine, in which the Mongolian government has 34% equity (Rio Tinto, 2025). A bill is also currently before the Mongolian Parliament to review royalty rates as part of a revised Mining Law, drafted and initially presented to Parliament during 2024 (GBR, 2024). The Mongolian government is acutely aware of the need to improve the attractiveness of mineral resources industry investment in Mongolia in which taxation and royalty changes are among initiatives receiving consideration (Mongolia Inc., 2023). In discussions with ERM, XAM expressed a high degree of confidence in being able to negotiate an attractive royalty rate with the Mongolian government, which will not be the 5% achieved for Oyu Tolgoi but would still be attractive for a project with Kharmagtai's potential scale and significance to the Mongolian economy.

ERM supports this view and accepts the use of the 8.34% royalty rate proposed in the PFS as reasonable.

### 6.1.8 TAXATION

Mongolia is perceived to have higher than average capital costs due to poor infrastructure in remote areas (including South Gobi province). A benchmarking study by MinEx Consulting in 2019 ranked Mongolia thirteenth of 20 countries surveyed (MinEx Consulting, 2022).

Mongolia has a complex set of tax, royalty and investment rules. The corporate tax rate of 25% is low compared with many countries. Mongolia's effective tax rate (ETR), however, was estimated by MinEx Consulting to be around 53% for copper projects which compares unfavourably with the average ETR of around 41% for copper projects at the decision to build stage in the 17 countries surveyed in the 2022 study (MinEx Consulting, 2022) (Figure 6-2). The ETR estimated by MinEx Consulting includes all sources of government revenue generated

For personal use only

by the project, including royalties, company tax and duties on imported equipment associated with construction and operations. The tax rate for individual projects in Mongolia will vary in response to the negotiation of royalties in project investment agreements. The ETR for open pit copper projects of around 53% estimated for Mongolia by MinEx Consulting corresponds with a rate that maximises government revenue (MinEx Consulting, 2022) which considers both direct government revenue via taxes and indirect value to government from expansion of the national economy (Figure 6-3).

The Hurdle Rate in Figure 6-3 is the minimum acceptable return required by the company for it to advance the project to the next stage (and ultimately to production). It is typically set at 1-5 percentage points above the Company’s risk adjusted cost of capital.

MinEx Consulting proposes that the tax rate for copper projects in Mongolia is currently set at a level that is too high to grow the country’s mining industry.

ERM’s discussions with XAM revealed that the Mongolian government is aware of this issue, which is driving regulatory reform incorporated in cost of capital and royalty estimates used in the Kharmagtai PFS.

Lowering the perceived business risk for a country has been shown to have the greatest impact in maximising the economic contribution of a country’s mining industry (MinEx Consulting, 2022).

The actual ETR that will be paid by XAM for the Kharmagtai project will be determined by the investment agreement negotiated between XAM and the Mongolian government, which could include reductions in royalties paid on mineral production and tariffs and sales taxes levied on construction materials and equipment used in both developing and operating the Kharmagtai mine. The ETR estimated by MinEx Consulting should be considered to be a maximum tax rate based on current legislation which the government is in the process of revising and can vary with companies by negotiations and parliamentary approval.

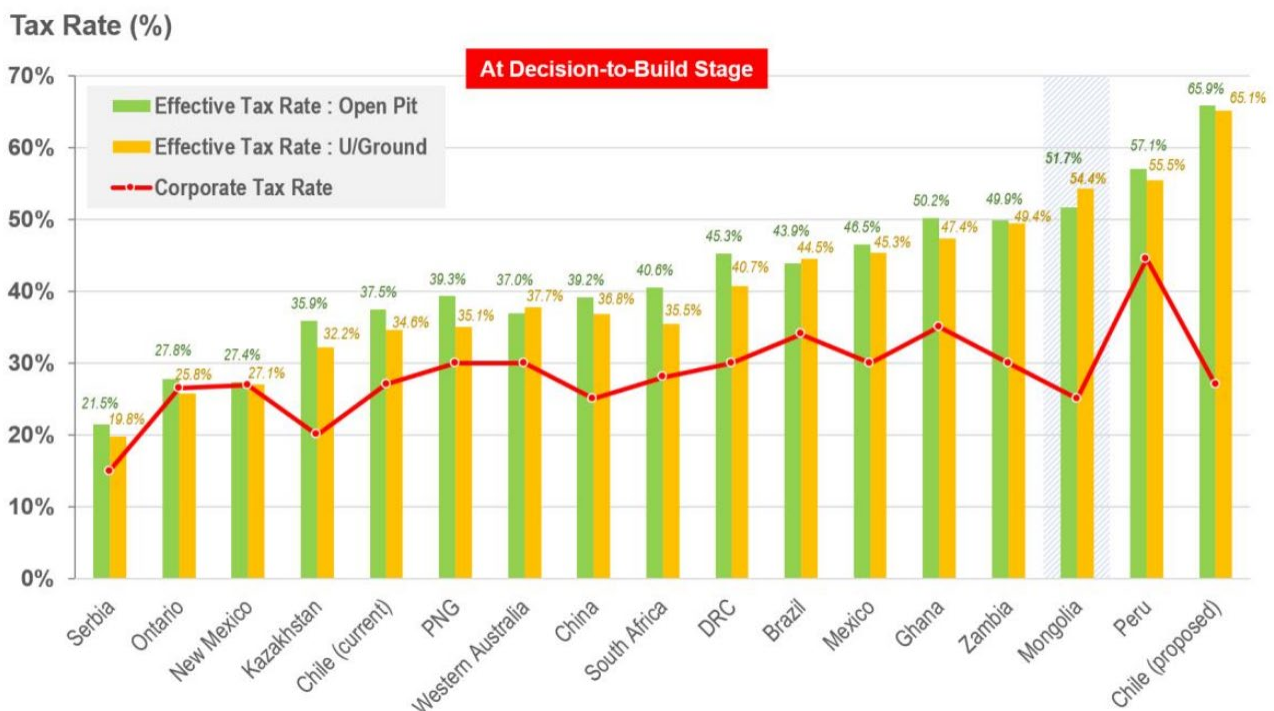

For personal use only



Figure 6-2: Tax rates for copper projects in selected countries

Source: MinEx Consulting, April 2022

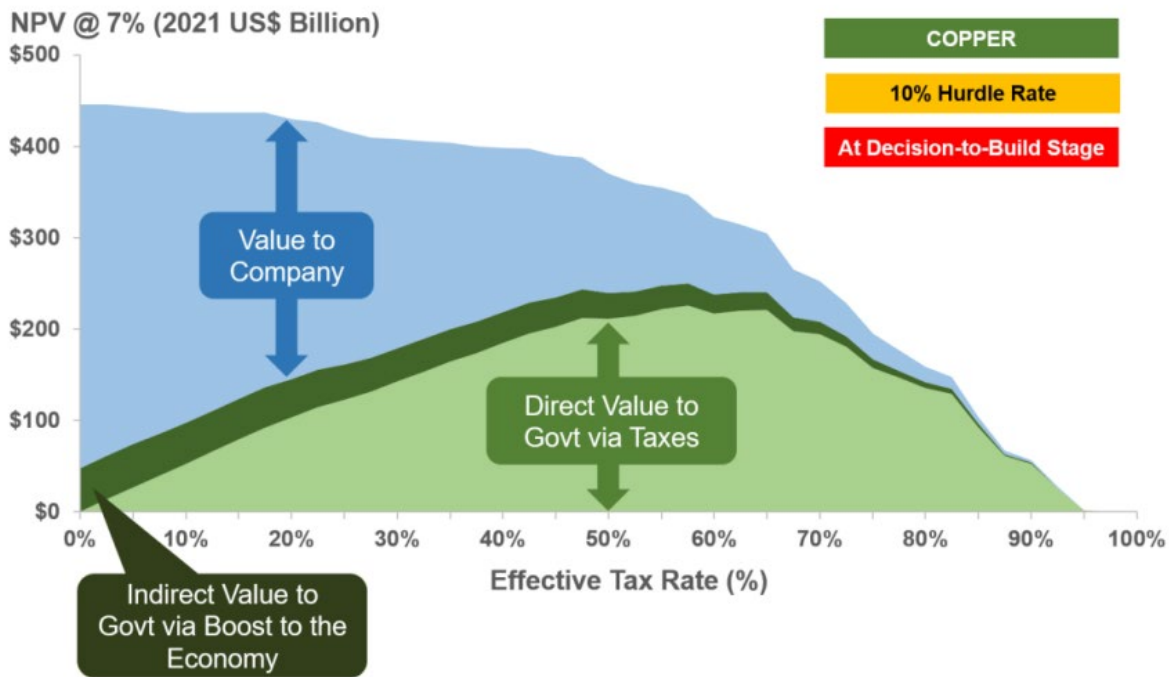

Note: Effective Tax Rate includes Corporate Tax + DWT + Royalties etc  
 Analysis based on 292 copper deposits found between 1995-2019 and US\$3.00/lb Cu price

Source: MinEx Consulting © April 2022

Figure 6-3: Effect of tax rate on the distribution of wealth for global copper projects 1995-2019

Source: MinEx Consulting, April 2022

The rate of taxation to which the project will be subjected may not be known until an investment agreement is established for the project. ERM proposes that reliance on taxation estimates incorporated in the project’s financial model is appropriate at this point in the project’s development.

For personal use only

## 7. IMPROVEMENT OPPORTUNITIES

The Kharmagtai PFS examined upside opportunities identified in the 2022 Scoping Study for the project (Xanadu Mines Ltd, 2022). These primarily comprise exploration, geotechnical, mining equipment and metallurgical opportunities, detailed in Table 7-1. ERM endorses each of these initiatives.

Table 7-1. Kharmagtai Project Improvement Opportunities

Opportunity	Description	Revenue Uplift	Unit Cost Reduction	Inventory Expansion
Pit Slopes	Steeper pit slopes through analysis of improved geotechnical engineering data.		✓	✓
Silver	Include silver in the Mineral Resource model to enable quantification of production. Silver is already recovered in the copper concentrate, and provides a no-cost revenue uplift	✓		
Copper Flotation	Copper recovery improvement through rougher and cleaner circuit improvement	✓		
Copper Recovery From Tails	11% of copper is lost through rougher tails and 8% through cleaner tails. Examine enhanced recovery options	✓		
Oxide Heap Leach	Approximately 20m of oxide material is treated as waste, with the exception of some high gold grade material. Heap leaching may recover additional copper and gold, cold weather performance and economics to be determined	✓		
Ore Sorting, Particle Separation	Examine coarse particle separation potential to reduce waste milled and processed.	✓	✓	
Mine Fleet	Examine options for trolley-assist and use of electric HME to reduce carbon emissions. In-pit crushing and conveying for ore and /or waste haulage, not addressed in the scoping study should also be examined.		✓	✓
Mineral Resource enhancement	Upgrade confidence in the existing mineral Resource and identify additional mineralisation associated with known deposits			✓
New Mineral Resource Discovery	The Kharmagtai project Mineral Resource remains open both laterally and at depth			✓

For personal use only

In particular, in-pit crushing and conveying (IPCC) warrants close investigation in ERM's opinion. Electric HME potential may be limited by extremely cold weather during winter and on very hot days experienced during summer.

For personal use only





## 8. PROJECT VALUATION DISCUSSION

### 8.1 OVERVIEW

At the effective date of this report (31<sup>st</sup> December 2024):

- The US-Australian dollar exchange rate was 0.6351 (Reserve Bank of Australia, 2025)
- The London Metals Exchange official copper bid price was US\$9,494.50 per tonne (LME, 2025) (Figure 8-1).

LME Copper Closing Prices graph



Figure 8-1: LME Copper Price 25 Feb 2024—24 Feb 2025

Source: (LME, 2025)

Monthly average copper prices exhibited considerable variability during the twelve months prior to February 2025, trading between US\$8,309.4 per tonne in February 2024 to US\$10,127.8 in May 2024. The average annual price during the 12 months prior to the effective date of this report was US\$9,195.7 per tonne.

### 8.2 MARKET CAPITALISATION

XAM’s ASX share price on the effective date of this report closed at A\$0.05 per share, which represented a market capitalisation of A\$86.05 million. XAM’s share price history between February 2024 and February 2025 is presented in Figure 8-2.

### 8.3 PROJECT EQUITY

Two of the three projects in which XAM is involved in Mongolia (Kharmagtai and Sant Tolgoi) are joint ventures. The Red Mountain project licence is held by Vantage LLC, a Mongolian registered 100% owned subsidiary of XAM. XAM’s equity in each project is presented in Table 8-1.

For personal use only

**XAM ASX Chart**



Figure 8-2: XAM share price history for the 12 months to 25 February 2025

Table 8-1: XAM Project Equity

Project	XAM Equity (%)	Other Major Participants
Kharmagtai	38.25	Zijin Mining Group Co. Ltd (38.25%) Ganbayar Lkhagvasuren (10.0%) QGX Ltd (10.0%)
Red Mountain	100.0	The licence is held by Vantage LLC, a Mongolian registered subsidiary of XAM
Sant Tolgoi	0.0	STSM LLC (100.0%). XAM is in the first stage of earning an interest of up to 80% in the project. The initial stage will enable XAM to earn 51% of the project by spending US\$1 million on exploration over 24 months (by January 2026)

**8.4 COMPARABLE TRANSACTIONS**

A summary of comparable transactions identified by ERM is presented in Table 8-2, Table 8-3 and Table 8-4. ERM elected to confine the search for comparable transactions for which the primary commodity was copper present in porphyry-style mineralised systems in Mongolia and Kazakhstan, and between 2000 and 2024. The search employed the S&P Capital IQ database This represents the period for which ERM has data available and which coincided with these countries’ transition to market economies from centrally planned, Soviet-style systems.

For personal use only

Table 8-2: Comparable Transactions

Project	Commodities	Seller	Buyer	Country	Date Announced	Reserves / Resources	Deal Value	Equity	R&R Cu Equiv.	
							US\$M	%	kt	\$/t
Bronze Fox	Cu, Au, Ag, Mo	Kincore Copper Ltd	Woomera Mining Ltd	Mongolia	30-Sep-24	Resources	404.0	80.0	440.8	0.79
Sharga <sup>1</sup>	Cu, Au, Ag, Zn	Undisclosed Seller	Aranjin Resources Ltd	Mongolia	19-May-21		2.46	100.0		
Bayan Undur <sup>1</sup>	Cu	Undisclosed Seller	Aranjin Resources Ltd	Mongolia	4-Nov-19			100.0		
Koksay <sup>2</sup>	Cu, Au, Ag, Mo	Kaz Minerals Plc	China Nonferrous Metal Industry's Foreign Engineering and Construction Limited	Kazakhstan	6-Nov-18		0.07	19.4		
Karchiga	Cu, Au	Orsu Metals Corporation	CMSS Global Supply and Trading FZC	Kazakhstan	3-Oct-17	Reserves	5.98	94.75	964.5	35.7
						Resources + Reserves			1089.1	31.6
Shuak <sup>3</sup>	Cu, Au, Ag, Mo	GRK Aksu	Central Asia Metals Plc	Kazakhstan	22-Nov-16		1984.0	80.0		
Erdenet Mining Corp	Cu, Mo, Ag, Sb, Bi	Russian Technologies State Corporation	Mongolian Copper Corporation LLC	Mongolia	28-Jun-16	Reserves	500.0	49.0	2099.9	238.1
						Resources + Reserves			4140.7	120.8
Kogodai	Cu, Ag	Orau Metals Corp.	Karasat Trading FZE	Kazakhstan	11-Apr-16		0.01	51.0		

For personal use only

Project	Commodities	Seller	Buyer	Country	Date Announced	Reserves / Resources	Deal Value	Equity	R&R Cu Equiv.	
							US\$M	%	kt	\$/t
Mongolian Assets <sup>1</sup>	Cu, Ag	Carajas Copper Co. Ltd	Rare Elements LLC	Mongolia	2-Mar-16		32.0	80.0		
Koksay	Cu, Au, Ag, Mo	CCC Mining Construction BV	Kazakhmya Plc	Kazakhstan	27-Feb-14		260.0	100.0		
FML Kazakhstan LLP	Cu, Au, Ag	Frontier Mining Ltd	Union Transnationale Miniere SA	Kazakhstan	26-Feb-14	Resources + Reserves	30.0	100.0	21319.3	8.5
Kharmagtai	Cu, Au	Turquoise Hill Resources Ltd	Mongol Metals LLC	Mongolia	3-Feb-14	Reserves	14.0	90.0	4120.7	20.6
Karchiga	Cu, Au	Unnamed	Orsu Metals Corp	Kazakhstan	20-May-10					
Nergui	Cu, Au, Ag	Winner Progress Ltd	Solartech International Holdings Ltd	Mongolia	4-Dec-09	Reserves	193.6	100.0	18963.6	102.1
Benkala	Cu	Coville Intercorp Ltd	Frontier Mining Ltd	Kazakhstan	6-Sep-07	Resources	21.0	50.0	1396.5	15.0
Oyu Tolgoi	Cu, Au	Ivanhoe Mines Ltd	Rio Tinto Plc	Mongolia	16-Oct-06	Reserves	691.5	19.9	13024.0	530.9
						Resources + Reserves			7897348.0	87.6

### Notes

1. early-stage (pre-resource) exploration project sale
2. 19.4% equity in exchange for US\$70,000 capital equipment
3. 80% equity in return for \$1.98 capital investment



Table 8-3: Comparable Transactions Adjusted to 31 Dec 2024

Project	Commodities	Seller	Buyer	Country	Date Announced	Reserves / Resources	Deal Value	Equity	R&R Cu Equiv.	
							US\$M	%	kt	\$/t
Bronze Fox	Cu, Au, Ag, Mo	Kincore Copper Ltd	Woomera Mining Ltd	Mongolia	30-Sep-24	Resources	441.1	80.0	440.8	0.86
Sharga <sup>1</sup>	Cu, Au, Ag, Zn	Undisclosed Seller	Aranjin Resources Ltd	Mongolia	19-May-21		2.31	100.0		
Bayan Undur <sup>1</sup>	Cu	Undisclosed Seller	Aranjin Resources Ltd	Mongolia	4-Nov-19			100.0		
Koksay <sup>2</sup>	Cu, Au, Ag, Mo	Kaz Minerals Plc	China Nonferrous Metal Industry's Foreign Engineering and Construction Limited	Kazakhstan	6-Nov-18		0.11	19.4		
Karchiga	Cu, Au	Orsu Metals Corporation	CMSS Global Supply and Trading FZC	Kazakhstan	3-Oct-17	Reserves	9.7	94.75	964.5	57.6
						Resources + Reserves			1089.1	51.0
Shuak <sup>3</sup>	Cu, Au, Ag, Mo	GRK Aksu	Central Asia Metals Plc	Kazakhstan	22-Nov-16		3194.4	80.0		
Erdenet Mining Corp	Cu, Mo, Ag, Sb, Bi	Russian Technologies State Corporation	Mongolian Copper Corporation LLC	Mongolia	28-Jun-16	Reserves	856.6	49.0	2099.9	407.9
						Resources + Reserves			4140.7	206.9
Kogodai	Cu, Ag	Orau Metals Corp.	Karasat Trading FZE	Kazakhstan	11-Apr-16		0.02	51.0		
Mongolian Assets <sup>1</sup>	Cu, Ag	Carajas Copper Co. Ltd	Rare Elements LLC	Mongolia	2-Mar-16		49.0	80.0		

Project	Commodities	Seller	Buyer	Country	Date Announced	Reserves / Resources	Deal Value	Equity	R&R Cu Equiv.	
							US\$M	%	kt	\$/t
Koksay	Cu, Au, Ag, Mo	CCC Mining Construction BV	Kazakhmya Plc	Kazakhstan	27-Feb-14		364.0	100.0		
FML Kazakhstan LLP	Cu, Au, Ag	Frontier Mining Ltd	Union Transnationale Miniere SA	Kazakhstan	26-Feb-14	Resources + Reserves	46.0	100.0	21319.3	13.1
Kharmagtai	Cu, Au	Turquoise Hill Resources Ltd	Mongol Metals LLC	Mongolia	3-Feb-14	Reserves	21.5	90.0	4120.7	31.6
Karchiga	Cu, Au	Unnamed	Orsu Metals Corp	Kazakhstan	20-May-10		8.4	24.75		
Nergui	Cu, Au, Ag	Winner Progress Ltd	Solartech International Holdings Ltd	Mongolia	4-Dec-09	Reserves	245.2	100.0	18963.6	129.3
Benkala	Cu	Coville Intercorp Ltd	Frontier Mining Ltd	Kazakhstan	6-Sep-07	Resources	13.9	50.0	1396.5	17.5
Oyu Tolgoi	Cu, Au	Ivanhoe Mines Ltd	Rio Tinto Plc	Mongolia	16-Oct-06	Reserves	873.5	19.9	13024.0	670.7
						Resources + Reserves			7897348.0	110.6

### Notes

4. early-stage (pre-resource) exploration project sale
5. 19.4% equity in exchange for US\$70,000 capital equipment
6. 80% equity in return for \$1.98 capital investment



Table 8-4: Comparable Transactions Adjusted to 31 Dec 2024 and 100% Equity

Project	Commodities	Seller	Buyer	Country	Date Announced	Reserves / Resources	Deal Value	Equity	R&R Cu Equiv.	
							US\$M	%	kt	\$/t
Bronze Fox	Cu, Au, Ag, Mo	Kincore Copper Ltd	Woomera Mining Ltd	Mongolia	30-Sep-24	Resources	551.4	100.0	551.0	0.9
Sharga <sup>1</sup>	Cu, Au, Ag, Zn	Undisclosed Seller	Aranjin Resources Ltd	Mongolia	19-May-21		2.3	100.0		
Bayan Undur <sup>1</sup>		Undisclosed Seller	Aranjin Resources Ltd	Mongolia	4-Nov-19			100.0		
Koksay <sup>2</sup>	Cu, Au, Ag, Mo	Kaz Minerals Plc	China Nonferrous Metal Industry's Foreign Engineering and Construction Limited	Kazakhstan	6-Nov-18		0.6	100.0		
Karchiga	Cu, Au	Orsu Metals Corporation	CMSS Global Supply and Trading FZC	Kazakhstan	3-Oct-17	Reserves	10.2	100.0	1018.0	57.6
						Resources + Reserves			1149.4	51.0
Shuak <sup>3</sup>	Cu, Au, Ag, Mo	GRK Aksu	Central Asia Metals Plc	Kazakhstan	22-Nov-16		3992.9	100.0		
Erdenet Mining Corp	Cu, Mo, Ag, Sb, Bi	Russian Technologies State Corporation	Mongolian Copper Corporation LLC	Mongolia	28-Jun-16	Reserves	1748.1	100.0	4285.4	407.9
						Resources + Reserves			8450.4	206.9
Kogodai	Cu, Ag	Orau Metals Corp.	Karasat Trading FZE	Kazakhstan	11-Apr-16		0.04	100.0		
Mongolian Assets <sup>1</sup>	Cu, Ag	Carajas Copper Co. Ltd	Rare Elements LLC	Mongolia	2-Mar-16		61.3	100.0		

Project	Commodities	Seller	Buyer	Country	Date Announced	Reserves / Resources	Deal Value	Equity	R&R Cu Equiv.	
							US\$M	%	kt	\$/t
Koksay	Cu, Au, Ag, Mo	CCC Mining Construction BV	Kazakhmya Plc	Kazakhstan	27-Feb-14		364.0	100.0		
FML Kazakhstan LLP	Cu, Au, Ag	Frontier Mining Ltd	Union Transnationale Miniere SA	Kazakhstan	26-Feb-14	Resources + Reserves	46.0	100.0	21319.3	13.1
Kharmagtai	Cu, Au	Turquoise Hill Resources Ltd	Mongol Metals LLC	Mongolia	3-Feb-14	Reserves	23.8	100.0	4578.5	31.6
Karchiga		Unnamed	Orsu Metals Corp	Kazakhstan	20-May-10		34.0	100.0		
Nergui	Cu, Au, Ag	Winner Progress Ltd	Solartech International Holdings Ltd	Mongolia	4-Dec-09	Reserves	245.2	100.0	18963.6	129.3
Benkala	Cu	Coville Intercorp Ltd	Frontier Mining Ltd	Kazakhstan	6-Sep-07	Resources	27.9	100.0	1396.5	17.5
Oyu Tolgoi	Cu, Au	Ivanhoe Mines Ltd	Rio Tinto Plc	Mongolia	16-Oct-06	Reserves	4389.6	100.0	6544.7	670.7
						Resources + Reserves			39685.2	110.6

### Notes

7. early-stage (pre-resource) exploration project sale
8. 19.4% equity in exchange for US\$70,000 capital equipment
9. 80% equity in return for \$1.98 capital investment





Only 16 relevant transactions were identified. Of these, ten projects had identified Mineral Resources and/or Ore Reserves while six were early (pre-Resource) projects. ERM's search for projects was limited to Kazakhstan and Mongolia to ensure consistency in exploration and mining investment attractiveness, regulatory systems and logistics associated with developing new mining projects.

The identified transactions are concentrated between 2014 and 2017 which represented a period of intense interest in mining investment in central Asia which has declined noticeably in subsequent years due to changes in royalty and company taxation regimes in Mongolia and investment conditions in Kazakhstan (Meja & Aliakbari, 2024). Mongolia was ranked 63 and Kazakhstan 79 for mining investment attractiveness, and 82 and 69 for government policy perception of 86 countries covered by the 2023 Fraser Institute survey. This is despite both countries being ranked favourably in terms of mineral potential (31 and 58 for Mongolia and Kazakhstan respectively of 58 countries for which survey submissions were received).

The comparable transactions information was adjusted to bring all results to the effective date of this report (25 February 2025) (Table 8-3, Table 8-4). These results were also recalculated to provide a 100% equity basis for comparison purposes (Table 8-4).

Transactions were considered to be comparable by comparing a range of factors including:

- mineralisation style (porphyry copper and porphyry copper-gold silver mineralisation).
- similar geography (central Asian projects received closest attention).
- transactions involved acquisition of a similar level of equity in the projects being compared with XAM's assets.
- excluding extreme outlier transactions values, interpreted to represent both discounted and enhanced asset valuations influenced by factors other than the key geological attributes of the deposit (mineralisation tonnes and grade, development potential and mineability, taking account of factors including permitting and perception of other non-technical factors influencing project development).
- where the range of values provided by transactions considered to involve assets comparable with XAM's projects provide a broad spread of values, ERM has calculated the mean or geometric mean of the values of those transactions considered comparable and used  $\pm 25\%$  of this value to represent lower and upper bounds for expected market values.
- The values used for projects with publicly estimated Ore Reserves and Mineral Resources are based on the value realised per tonne of contained metal represented by the reported Mineral Resource and Ore Reserve estimates. The use of contained metal negates consideration of different average grades evident between the deposits involved in comparable transactions.
- Deposits for which Mineral Resources and Ore Reserves have not been reported are valued using assessments of geological prospectivity and enhancement of value achieved by exploration to the date of each comparable transaction. This approach is somewhat empirical but is conducted according to widely applied and broadly accepted criteria established for valuation techniques developed for pre-resource stage projects.

For personal use only

Adjusting the value of comparable transactions between the actual date of the transaction and the effective date of this report is achieved by multiplying the transactions value by the ratio of the copper price at the transaction date and the report date. This approach is considered to account for both changes in the value of contained metal and exploration potential and market sentiment towards investment in the commodity of interest. The LME cash copper price was used as the basis for the adjustments performed in analysing transactions examined in this report.

The recent history of copper project transactions in Mongolia point to difficult conditions in which to realise value from existing, non-producing projects due to concerns relating to the legal and commercial framework affecting mineral resource development projects outweighing prospectivity and mineral resource discovery potential. This environment, however, can create opportunities for companies willing to attempt to manage the inherent risks.

## 8.5 VALUATION OPINION: KHARMAGTAI DEPOSIT

### 8.5.1 INCOME-BASED VALUATION

ERM agrees that the preferred approach to valuing the Kharmagtai deposit is using the project's financial model, which will require consideration of issues associated with:

- Reassessment of royalties payable in Mongolia, with continued buoyancy of the copper market will result in royalty rates of 20% for copper in Mongolia, coupled with the levying of royalties on minor and trace metals exported from Mongolia in concentrates that may not be a source of revenue for producers, but will impose additional costs. ERM proposes that the royalty rate of 8.36 per cent proposed by XAM needs to be 20 per cent to align with the current Mongolian Mining Law.
- Obtaining a contract mining cost estimate from at least two contractors is considered essential by ERM during the project's Feasibility Study. ERM agrees that the current mining cost may be achievable by a mining contractor in Mongolia and has been estimated by consultants who prepared the Kharmagtai PFS in a rigorous manner.

### 8.5.2 MINERAL RESOURCES EXCLUSIVE OF ORE RESERVES

The Ore Reserve for the Kharmagtai project does not include all mineralisation included in the deposit's MRE. The additional mineralisation largely occurs outside optimum pit shells generated for sections of the deposit using parameters included in the project's current financial model. An estimate of the project's Mineral Resource exclusive of the Ore Reserve is presented in Ore loss is an adjustment that accounts for less than 100% effective grade control which results in some mineralisation classified as ore being accidentally dispatched to waste dumps during mining or inappropriately classified as waste during production planning. Dilution represents mining of unmineralised material with ore, which may be both accidental or deliberate when the economic impact of ore loss exceeds that of minimising ore loss by mining slightly beyond estimated ore-waste boundaries. The impact of dilution is that run of mine ore grades will be slightly lower, and the tonnes mined slightly higher than the mineral resources estimated in the area being mined. Both ore loss and dilution result in a somewhat indirect relationship between Mineral Resources and Ore Reserves.

Table 8-5. Mining dilution and ore loss of five per cent has been used in estimating the residual Mineral Resource.

Ore loss is an adjustment that accounts for less than 100% effective grade control which results in some mineralisation classified as ore being accidentally dispatched to waste dumps during mining or inappropriately classified as waste during production planning. Dilution represents mining of unmineralised material with ore, which may be both accidental or deliberate when the economic impact of ore loss exceeds that of minimising ore loss by mining slightly beyond estimated ore-waste boundaries. The impact of dilution is that run of mine ore grades will be slightly lower, and the tonnes mined slightly higher than the mineral resources estimated in the area being mined. Both ore loss and dilution result in a somewhat indirect relationship between Mineral Resources and Ore Reserves.

Table 8-5: Kharmagtai Project - Mineral Resources Exclusive of Ore Reserves (allowing 5% Dilution and Ore Loss)

Cut-off (% Cu Eq)	Classification	Tonnes		Grades		Contained Metal		
		(Mt)	Cu Eq (%)	Cu (%)	Au (g/t)	Cu Eq (kt)	Cu (kt)	Au (koz)
Open Cut 0.13%	Indicated	534	0.29	0.20	0.15	1,520	1,064	2,607
	Inferred	800	0.25	0.18	0.12	1,900	1,400	3,000
	Total	1,334	0.26	0.19	0.13	3,420	2,464	5,607
Underground 0.30%	Indicated	40	0.45	0.32	0.24	150	100	250
	Inferred	160	0.41	0.31	0.19	650	500	950
	Total	200	0.42	0.31	0.2	800	600	1,200
<b>Kharmagtai Total</b>		<b>1,534</b>	<b>0.28</b>	<b>0.20</b>	<b>0.14</b>	<b>4,220</b>	<b>3,064</b>	<b>6,807</b>

Both open cut and underground mines employ production reconciliation to recognise when ore loss is occurring and minimise its impact on operations.

Indicated Resources reported as potentially amenable to open cut mining occur outside optimum pits generated for the project from the Mineral Resource model. This mineralisation may be unable to be mined economically and, therefore, should be considered unlikely to represent a source of future value for the project under prevailing mining cost and ore value relationships. These relationships are subject to change in time due to both price and mining cost changes over time.

### 8.5.3 ANALYSIS OF COMPARABLE TRANSACTIONS

Projects with comparable contained metal contents to Kharmagtai, with both Ore Reserves and Mineral Resources, in Mongolia and Kazakhstan since 2007 have changed ownership for between US\$10.2 million and US\$245.2 million in 2024-dollar terms (Table 8-4). This represents a value of between US\$13.1 and US\$57.6 per tonne (average of US\$17.9 per tonne) of contained metal on a copper equivalent basis. The Kharmagtai project is estimated to have a Mineral Resource, inclusive of Ore Reserves, of 6.5 Mt of contained metal on a copper equivalent basis, which would correspond with a value of between US\$85 and US\$374 million, with a preferred value of US\$116 using the weighted average copper equivalent value per tonne of contained metal. The range of values obtained from the comparable transactions is quite broad. ERM proposes the use of  $\pm 25\%$  of the preferred value to estimate lower and upper valuation estimates of US\$87 million and US\$145 million, respectively.

In ERM's opinion, using the available comparable transaction information, the Kharmagtai project has a market value of between US\$87 million and US\$145 million, with a preferred value of US\$116 million, based on the in-situ Mineral Resource reported for the project.

For the Mineral Resource exclusive of Ore Reserves, the estimated value would be US\$55 to US\$242 million, with a preferred value of US\$75 million. Using  $\pm 25\%$  of the preferred value to estimate lower and upper valuation estimates of US\$56 million and US\$94 million, respectively.

#### 8.5.4 RULE OF THUMB VALUATION OPINION

A Rule of Thumb approach is frequently applied to value Mineral Resources not included in a project's Ore Reserve. ERM is reluctant to ascribe significant value to this mineralisation in this case due to a combination of factors:

- Indicated Mineral Resource reported as having prospects for open pit mining should have been included in the optimum pit shells developed for the deposit if it met the requirement of having reasonable prospects for economic extraction
- Inferred mineralisation reported as having prospects for open pit mining was not considered during open pit optimisation and may contribute to an increased Ore Reserve if further drilling justifies increasing confidence in this mineralisation following future drilling
- the Mineral Resource considered potentially amenable to underground mining at Kharmagtai is relatively small and would need to be extracted using underground bulk mining techniques that typically require a large resource to justify the cost of establishing the necessary underground development and infrastructure required to viably undertake this form of mining
- no work has been completed to identify coherent mineralised volumes with demonstrated potential to be recovered by underground bulk mining
- there are few mining contractors with the experience and equipment required to operate an underground bulk mining operation

ERM proposes that mineralisation not included in the project's Ore Reserve should be considered to represent an exploration target rather than a Mineral Resource that could be meaningfully assessed using a Rule of Thumb valuation approach. There appears to be few opportunities for this additional value to be realised at the current stage of the project, requiring application of a different valuation approach.

#### 8.5.5 PROSPECTIVITY ENHANCEMENT MULTIPLIER

Exploration expenditure by XAM provides a basis for recognising the value of Kharmagtai mineralisation not included in the project's Ore Reserve.

XAM have spent approximately US\$11.4 million (A\$17.5 million) on exploration and mineral resource evaluation on the Kharmagtai project between 2022 and 2024 (Table 8-6). More than half of the total expenditure was related to open pit resource evaluation drilling during 2023.

Table 8-6: Kharmagtai Project Exploration Expenditure 2022-2024 (US\$)

	2022	2023	2024	Total
Kharmagtai Exploration, PEA (US\$)	1.4	2.5	1.3	
Kharmagtai Resource Delineation, PFS (US\$)		6.1		
XAM Total Exploration Expenditure (US\$)	1.4	8.7	1.3	
Prospectivity Enhancement Multiplier	1.0–1.5	2.5	2.5	
Valuation (Expenditure x PEM) (US\$)	1.4–2.1	21.7	3.3	26.4–27.1

The figures reported in Table 8-6 are based on XAM's records but were not audited for the purposes of this project.

Exploration during 2022 involved evaluation of the project and securing participation in the project with QGX Ltd, which contributed to confirmation of the project's potential recognised by previous explorers. This resulted in confirmation of several targets that were intensively drilled during 2023 resulting in definition of a resource, able to be used as the basis of an Ore Reserve estimate with further studies completed during 2024. The highest value mineralisation, now contributing to the project's Ore Reserve estimate is surrounded by a number of additional targets that are candidates for further drilling to increase the quantity of mineralisation present and improve confidence in, and the classification of identified Mineral Resources

ERM proposes a PEM of 2.5 for the project, consistent with drilling outside the area where an Ore Reserve has been identified leading to delineation of areas where additional drilling is expected to result in recognition of additional mineral resources able to form the basis of additional Ore Reserves.

This provides a valuation opinion of US\$28.5 million in which XAM has 38.25% equity following the recent acquisition of a 38.25% interest in the project by Zijin Mining by diluting XAM's equity, equivalent to US\$10.9 million.

## 8.6 VALUATION OPINION: RED MOUNTAIN DEPOSIT

### 8.6.1 OVERVIEW

Red Mountain is an advanced but pre-resource exploration project, in which a 90% interest was acquired by XAM in 2017 (Xanadu Mines Ltd, 2018). The project is held under a 57 square kilometre mining licence in a geologically prospective region valid for 30 years. Details of the project's acquisition were not available for review in preparing this report. ERM believes that Vantage LLC secured title to vacant land available for exploration with an unnamed local partner.

A MRE has not been published for the project, but positive results have been received from ongoing exploration. Epithermal gold and porphyry copper-gold mineralisation targets have been identified within the Red Mountain licence.

For personal use only

## 8.6.2 ANALYSIS OF COMPARABLE TRANSACTIONS

The comparable transactions identified for XAM's Mongolia projects include five projects at pre-resource stage that were the subjects of outright sales or joint ventures in which the purchaser secured either 51% or 80% equity in the projects. These transactions occurred mainly between 2016 and 2021, which covers the period of greatest commercial activity and interest in copper-gold projects in Mongolia.

Available data permits only an empirical assessment of the transactions, which ranged in value, mainly, between US\$40,000 and US\$2.2 million on a 100% equity, 2024-dollar basis with two exceptions, where an 80% interest in a portfolio of tenements in Mongolia sold in 2016 for US\$32 million, or US\$46 million in 2024-dollar terms and a pre-resource project in Kazakhstan sold in 2014 for US\$341 million in 2024-dollar terms. The purchasers in these cases were local (Mongolian and Kazakh) groups respectively.

ERM proposes an empirical value of US\$2.0 million for Red Mountain, which is at the top of the comparable transactions range (adjusted for XAM's 90% equity) but is considered to reflect the advanced status of the Red Mountain project. This valuation would be superseded by valuations based on exploration results and identified Mineral Resources when a MRE is released for the project by XAM.

## 8.6.3 PROSPECTIVITY ENHANCEMENT MULTIPLIER

Exploration expenditure by XAM provides a basis for recognising value of mineralisation identified at Red Mountain. A PEM valuation opinion for Red Mountain is presented in Table 8-7 (below). No information was available for expenditure between 2017 and 2022 which is interpreted to have comprised low-cost, early-stage project generation that contributed to both securing the licence, reviewing previous work and generating targets for subsequent drill testing.

Table 8-7: Red Mountain Project Exploration Expenditure 2022-2024 (US\$)

	2022	2023	2024	Total
<b>Red Mountain Exploration (US\$)</b>	1.1	0.2	1.4	
<b>Prospectivity Enhancement Multiplier</b>	1.5 - 2.0	1.5 - 2.0	2.5	
<b>Valuation (Expenditure x PEM) (US\$)</b>	1.7 - 2.2	0.3 - 0.4	3.5	<b>5.5 - 6.1</b>

A high PEM has been proposed for the project due to the interpreted ability of limited additional drilling to result in public reporting of a maiden Mineral Resource for one or more prospects within the Red Mountain licence.

## 8.7 VALUATION OPINION—SANT TOLGOI

### 8.7.1 JV STATUS

Sant Tolgoi is subject to a newly formed JV between XAM and STSM in January 2024 (Xanadu Mines Ltd, 2024a) to earn up to 80 per cent of the project by meeting the requirements of several agreed stages (Philipps, 2024). XAM is, essentially, in the first stage of the agreement which will entitle it to a 51% interest in the project upon expenditure of US\$2 million on

For personal use only

exploration within two years (by January 2026). Initial exploration results were released by XAM to the ASX in November 2024 (Xanadu Mines Ltd, 2024c).

At the date of this report, although XAM is progressing towards securing a 51% interest in the Sant Tolgoi project, the Company has no interest that can be preserved and traded with third parties until the initial JV milestone is achieved. A copy of the Farm in Agreement between XAM and STSM, executed in July 2024, was provided to ERM for review by XAM during preparation of this report. ERM is, however, unable to attribute value to the project until the requirements of the first stage of the JV are achieved.

For personal use only

## 9. VALUATION OPINION AND CONCLUSIONS

### 9.1 VALUATION OPINION

The valuation opinion presented here comprises:

1. Kharmagtai project valuation based on Mineral Resources exclusive of Ore Reserves. The project's Ore Reserves have been valued using an income-based approach by BDO.
2. The value of Red Mountain as an advanced exploration project.

The Sant Tolgoi project has been assigned no value. XAM has entered into an agreement to acquire an interest in the project through investment in ongoing exploration but has yet to satisfy the trigger for XAM earning equity in the project.

In relation to Red Mountain and Sant Tolgoi, the valuations of these projects will increase with the release of a maiden MRE for Red Mountain and XAM meeting the initial commitment required to earn equity in the project.

#### 9.1.1 COMPARABLE TRANSACTIONS

ERM conducted a search for comparable transactions using S&P's Capital IQ database. It focused on copper-gold projects in Mongolia and Kazakhstan to confine results to broadly comparable geological settings and geopolitical regimes with implications for exploration investment attractiveness. This limited the number of comparable transactions identified, especially in recent years. Transactions more than 10 years prior to the effective date of this report were considered cautiously due to the influence of geopolitical changes in both Mongolia and Kazakhstan over the past decade in particular but extending back to the lessening of Russian influence in Mongolia that commenced during the late 1990s and has led to several paths being followed to minerals industry regulation in Mongolia in particular since.

The transactions considered comparable by ERM presented in Table 8-2 to Table 8-4 comprise:

1. Sale of 94.75% of the Karchiga deposit in Kazakhstan by Orsu Metals Corporation to CMSS Global Supply and Trading FZC in October 2017
2. Sale of FML Kazakhstan LLP by Frontier Mining Ltd to Union Transnationale Miniere SA in February 2014
3. Sale of 90% of the Kharmagtai project in Mongolia by Turquoise Hill Resources Ltd to Mongol Metals LLC in February 2014
4. Sale of a 50% interest in the Bankala project in Kazakhstan by Coville Intercorp Ltd to Frontier Mining Ltd September 2007.

A further five transactions presented in Table 8-2 to Table 8-4 could be considered to be comparable but have been excluded from further analysis due to the very high dollar per tonne of Ore Reserves and Mineral Resources implied by the transaction values, which ERM considers may reflect factors that result in the transaction not reflecting market value, and would imply a very high multiplier for Mineral Resources and Ore Reserves that exceed industry accepted conventions. ERM has exercised discretion in excluding these from further consideration.

For personal use only



### 9.1.2 KHARMAGTAI PROJECT ORE RESERVE

The principal source of value for XAM's three exploration projects in Mongolia is the Ore Reserve estimated for the Kharmagtai project, the value of which is derived using the financial model for the project for which ERM has reviewed the inputs and identified several key concerns:

- ERM was concerned that the CAPEX estimated to be required by the project was low. ERM met with the consultants responsible for the CAPEX estimate presented in the PFS and is satisfied that the estimate was prepared in a manner consistent with industry best practice and satisfies PFS requirements. The difference between the CAPEX estimate for the Kharmagtai project and comparable projects globally may be attributed to the limited number of comparable projects in Mongolia available for comparison.
- The mining cost estimate for the project is considered by ERM to have been developed for the Kharmagtai PFS using a process that follows sound industry practice.

### 9.1.3 KHARMAGTAI MINERAL RESOURCE

ERM is concerned that a large proportion of the Indicated Mineral Resource reported for Kharmagtai as being potentially amenable to open cut mining has not been incorporated in the project's Ore Reserve which leverages open pit optimisation results based on the project's Mineral Resource model. Any Indicated Mineral Resource with reasonable prospects for open cut mining should report to the project's Ore Reserve but this has not occurred.

The underground Mineral Resource reported for the project is relatively small. ERM recommends that prospects for underground bulk mining need to be assessed to determine whether sufficient mineralisation is concentrated in coherent volumes that have potential to support the development of mining development and infrastructure required. The capital cost of block cave mining needs to be assessed, and the availability of suitable contractors confirmed if contract underground mining is to be considered as an option.

### 9.1.4 KHARMAGTAI VALUATION APPROACH

ERM has elected to use analysis of comparable transactions and exploration multiple approaches for developing a valuation opinion for the project. A Rule of Thumb valuation opinion was considered but discontinued due to concerns relating to the reporting of mineral resources discussed above.

### 9.1.5 RED MOUNTAIN

Red Mountain is a pre-resource exploration project where exploration is expected to result in public reporting of a MRE in the near future, which will provide additional valuation options for the project. This is also expected to contribute to significant enhancement of project value.

The project has been valued using analysis of comparable transactions and project exploration multiplier approaches.

### 9.1.6 SANT TOLGOI

ERM has not developed a valuation opinion for Sant Tolgoi. The JV between XAM and STSM has not reached a point where XAM has earned equity in the project, which ERM considers a trigger point for attribution of project value. Early exploration results are, however, clearly

For personal use only

encouraging and will represent a source of project value when the requirements of Stage 1 agreement between XAM and STSM are achieved.

## 9.2 VALUATION OPINION

A valuation opinion for XAM's Mongolia exploration projects is summarised in Table 9-1. The opinions listed in the table do not include the value of the Kharmagtai Ore Reserve.

Table 9-1: XAM Mongolian Projects Valuation Opinion

Value Source	Equity	Low	Preferred	High	Notes
	(%)	(US\$M)	(US\$M)	(US\$M)	
Kharmagtai comparable transactions	100.0	56	75	94	XAM has entered a JV with Zijun Mining that distributed XAM's former 76.5% equity in the project between the two groups. Shareholdings of other JV participants were not affected. The value quoted is based on the project's Mineral Resource exclusive of Ore Reserves.
	38.25	21	29	36	
Kharmagtai Prospectivity Enhancement Multiplier	100.0	26.4	26.8	27.1	XAM were contributing all exploration funds prior to the Zijin Mining agreement.
	38.25	10.1	10.3	10.4	
Red Mountain comparable transactions	100.0	1.5	2.0	3.2	Pre-resource exploration project, opinion based on limited suitable transactions.
Red Mountain Prospectivity Enhancement Multiplier	100.0	5.5	5.8	6.1	XAM is contributing all exploration funds.

Project valuation opinions based on comparable transactions are considered to represent market values. These are considerably lower than the technical values obtained using the Exploration Prospectivity Enhancement Approach, interpreted to reflect negative sentiment towards exploration and mining investment in Mongolia. The surveys that provide evidence of this are surveys of exploration and mining managers and investors in western countries, especially Canada, USA and Australia, which may express different sentiment to their counterparts in Mongolia, Kazakhstan and China. Companies based in western countries, however, are major sources of capital for investment in exploration and mining projects. Investment attractiveness has an undeniable influence on the market value of projects.

There is upside in the valuation opinions expressed in Table 9-1 that will be realised on the public reporting of Mineral Resources for the Red Mountain project and successful completion of the initial stage of the Sant Tolgoi JV.

### 9.3 CONCLUSIONS

ERM considers the PFS prepared for the Kharmagtai project to be an effective and accurate description of development options for the Kharmagtai project. Inputs to the financial models prepared for the project are also considered to be defensible and a suitable basis for further studies. Uncertainty exists regarding several important factors, including royalties and the project's cost of capital. The assumptions made in the PFS are considered to be well considered by ERM and able to be revised as necessary prior to completion of the project's FS.

Red Mountain is able to be valued as an exploration using market value and expenditure approaches. ERM expects that modest additional exploration will provide a basis for public reporting of a MRE for the project which will provide additional valuation options and enhance project value.

XAM have yet to reach a stage in the Sant Tolgoi JV agreement to secure equity in the project. Reaching this milestone will enable value to be ascribed to the project.

For personal use only

## 10. REFERENCES

- Byambajav, L. (2021, November 6). *Mongolia is Unique in levying the royalty on minor elements*. Retrieved from Australia Mongolia Extractives Programme: [https://amep.mn/news-detail/36?lang\\_id=2](https://amep.mn/news-detail/36?lang_id=2)
- Consensus Economics. (2024). *Energy, Metals & Agriculture Consensus Forecasts. Survey Date December 16, 2024*. London: Consensus Economics Inc.
- GBR. (2024, Aug 2). *Mining Regulations in Mongolia*. Retrieved from Global Business Reports: <https://www.gbreports.com/article/mining-regulations-in-mongolia>
- Goulevitch, J., & Eupene, G. (1994). Geoscience Rating for Valuation of Exploration Properties – Applicability of the Kilburn Method in Australia and Examples of its Use in the NT. *Mineral Valuation Methodologies Conference (VALMIN 94)* (pp. 175-189). Sydney: Australasian Institute of Mining and Metallurgy (AusIMM).
- JORC. (2012). *Australasian Code for Reporting of Exploration Results, Mineral Resources and Ore Reserves (The JORC Code, 2012 edition)*. Melbourne: Joint Ore Reserves Committee of The Australasian Institute of Mining and Metallurgy, Australian Institute of Geoscientists and Minerals Council of Australia (JORC).
- Kilburn, L. C. (1990, January 1). Valuation of Mineral Properties which do not contain Exploitable Reserves. *CIM Bulletin*, p. 4 pp.
- Lawrence, M. J. (2001). An Outline of Market-based Approaches for Mineral Asset Valuation Best Practice. *Mineral Asset Valuation Issues for the Next Millennium (VALMIN 2001)* (pp. 115-137). Perth: Australasian Institute of Mining and Metallurgy (AusIMM).
- Lawrence, M. J. (2011). Considerations in Valuing Inferred Resources. *VALMIN Seminar Series 2011-12* (pp. 93-102). Perth: Australasian Institute of Mining and Metallurgy (AusIMM).
- LME. (2025, January 10). *LME Copper*. Retrieved from LME An HKEX Company: <https://www.lme.com/en/metals/non-ferrous/lme-copper#Price+graphs>
- Lord, D., Etheridge, M., Wilson, M., Hall, G., & Uttley, P. (2001, April). Measuring Exploration Success: An alternate to the discovery-cost-per-ounce method of quantifying exploration effectiveness. *Society of Economic Geologists Newsletter 45*, pp. 1-16.
- McKibben, J. (2019). *Independent Specialist Report on the mineral assets held by Avenira Limited. Report for RSM Corporate Australia Pty Ltd, August 2019*. Perth: SRK Consulting (Australasia) Pty Ltd.
- MDO. (2025, February 7). *Oyu Tolgoi Mine*. Retrieved from MDO Mining Intelligence and News: <https://miningdataonline.com/property/1031/Oyu-Tolgoi-Mine.aspx>
- Meja, J., & Aliakbari, E. (2024). *Fraser Institute Annualk Survey of Mining Companies 2023*. Vancouver: Fraser Institute.
- MinEx Consulting. (2022). *Effective Tax Rate for Mining 2022*. Melbourne: Australian Aid - Australia Mongolia Extractives Programme.
- Mining Associates. (2018). *Independent Technical Report on the Red Mountain Property, Mongolia. Prepared by Mining Associates Ltd for Xanadu Mines Ltd. Effective Date 26 June 2018*. Brisbane: Mining Associated Pty Ltd.

- Mongolia Inc. (2023, Sep 28). *Exchange*. Retrieved from Mongolia Inc: <https://mongoliainc.com/8751/>
- O2 Mining Limited. (2024). *National Instrument 43-101 Amended and Restated Preliminary Economic Assessment Technical Report. Draft. Prepared for Xanadu Mines Limited. Effective Date of Technical Report: 4 April 2022. Project number: XML005. Issued 7 May 2024.*
- Onley, P. G. (2004). Multiples of Exploration Expenditure as a Basis for Mineral Property Valuation. *Mineral Valuation Methodologies Conference (VALMIN 94)* (pp. 191-197). Sydney: Australasian Institute of Mining and Metallurgy (AusIMM).
- Philipps, M. (2024, January 22). *Xanadu adds copper-nickel project to Mongolian operations*. Retrieved from Business News: <https://www.businessnews.com.au/article/Xanadu-adds-copper-nickel-project-to-Mongolian-operations>
- Reserve Bank of Australia. (2025, January 10). *Exchange Rates*. Retrieved from Reserve Bank of Australia: <https://www.rba.gov.au/statistics/tables/xls-hist/2023-current.xls>
- Rio Tinto. (2025, Feb 3). *Oyu Tolgoi*. Retrieved from Rio Tinto: <https://www.riotinto.com/en/operations/mongolia/oyu-tolgoi#:~:text=Oyu%20Tolgoi%20is%20jointly%20owned,on%20behalf%20of%20the%20owners.>
- Roscoe, W. E. (2002). Valuation of Mineral Exploration Properties Using the Cost Approach. *CIM Bulletin 95*, 105-109.
- S&P. (2024, December 13). *Transactions*. Retrieved from S&P Capital IQ Pro: [https://www.capitaliq.spglobal.com/web/client?auth=inherit#office/screener?perspective=275259&screenKey=ScreeenerScreen\\_46307738-3c2d-4216-882c-f667b8563a46](https://www.capitaliq.spglobal.com/web/client?auth=inherit#office/screener?perspective=275259&screenKey=ScreeenerScreen_46307738-3c2d-4216-882c-f667b8563a46)
- VALMIN. (2015). *Australasian Code for Public Reporting of Technical Assessments and Valuations of Mineral Assets*. Melbourne: The VALMIN Committee is a joint committee of The Australasian Institute of Mining and Metallurgy (AusIMM) and the Australian Institute of Geoscientists.
- Xanadu Mines Ltd. (2018, May 14). *Red Mountain - Drilling Commences*.
- Xanadu Mines Ltd. (2022). *Kharmagtai Project Scoping Study*. Sydney: Xanadu Mines Ltd.
- Xanadu Mines Ltd. (2024a). *Xanadu Enters Into New Magmatic Copper and Nickel Sulphide Project. ASX Release dated 22 January 2024.*
- Xanadu Mines Ltd. (2024b). *Encouraging Near Surface Copper and Gold Results Returned at Red Mountain. ASX Release dated 21 June 2024.*
- Xanadu Mines Ltd. (2024c). *High Priority Drill Targets Defined at Sant Tolgoi. ASX Announcement dated 20 November 2024.*
- Xanadu Mines Ltd. (2024d). *Kharmagtai Maiden Ore Reserve, Updated Mineral Resource. ASX Announcement dated 14 October 2024.*
- Xanadu Mines Ltd (2024e, December 2). *Mongolia's Next Major Copper Mine. Mines and Money London Presentation*. Retrieved from Xanadu Mines: <https://api.investi.com.au/api/announcements/xam/64a26fcc-7a3.pdf>

Xanadu Mines Ltd. (2024f). *Kharmagtai Prefeasibility Study 2024*. Sydney: Xanadu Mines Ltd.  
Retrieved from <https://api.investi.com.au/api/announcements/xam/f97d05ab-f06.pdf>

Xanadu Mines Ltd (2024g, September 10). *Copper-nickel focused exploration advancing at Sant Tolgoi Project*. Retrieved from ASX Announcements:  
<https://announcements.asx.com.au/asxpdf/20240910/pdf/067qmttxpv8zlh.pdf>

For personal use only



# ERM

## ERM HAS OVER 160 OFFICES ACROSS THE FOLLOWING COUNTRIES AND TERRITORIES WORLDWIDE

- Argentina
- Australia
- Belgium
- Brazil
- Canada
- China
- Colombia
- France
- Germany
- Ghana
- Guyana
- Hong Kong
- India
- Indonesia
- Ireland
- Italy
- Japan
- Kazakhstan
- Kenya
- Malaysia
- Mexico
- Mozambique
- The Netherlands
- New Zealand
- Peru
- Poland
- Portugal
- Romania
- Senegal
- Singapore
- South Africa
- South Korea
- Spain
- Switzerland
- Taiwan
- Tanzania
- Thailand
- UAE
- UK
- US
- Vietnam

### **ERM's [Office name]**

Level 9  
 260 Queen Street  
 Brisbane Qld 4506  
 Australia  
 T +61 (0) 7 3007 8414

**[www.erm.com](http://www.erm.com)**

For personal use only



For personal use only

1300 138 991

[www.bdo.com.au](http://www.bdo.com.au)

**AUDIT • TAX • ADVISORY**

**NEW SOUTH WALES  
NORTHERN TERRITORY  
QUEENSLAND  
SOUTH AUSTRALIA  
TASMANIA  
VICTORIA  
WESTERN AUSTRALIA**

BDO Corporate Finance Australia Pty Ltd ABN 70 050 038 170 AFS Licence No 247420 is a member of a national association of independent entities which are all members of BDO Australia Ltd ABN 77 050 110 275, an Australian company limited by guarantee. BDO Corporate Finance Australia Pty Ltd and BDO Australia Ltd are members of BDO International Ltd, a UK company limited by guarantee, and form part of the international BDO network of independent member firms. Liability limited by a scheme approved under Professional Standards Legislation.





# XANADU MINES

XANADU MINES LTD  
ABN 92 114 249 026

## Need assistance?



**Phone:**

1300 855 080 (within Australia)  
+61 3 9415 4000 (outside Australia)



**Online:**

[www.investorcentre.com/contact](http://www.investorcentre.com/contact)

XAM

MR SAM SAMPLE  
FLAT 123  
123 SAMPLE STREET  
THE SAMPLE HILL  
SAMPLE ESTATE  
SAMPLEVILLE VIC 3030



For personal use only

## Xanadu Mines Ltd Extraordinary General Meeting

The Xanadu Mines Ltd Extraordinary General Meeting will be held on Friday, 11 April 2025 at 11:00am (AEST). You are encouraged to participate in the meeting using the following options:



### MAKE YOUR VOTE COUNT

To lodge a proxy, access the Notice of Meeting and other meeting documentation visit [www.investorvote.com.au](http://www.investorvote.com.au) and use the below information:



**Control Number: 999999**

**SRN/HIN: I9999999999**

**PIN: 99999**

For Intermediary Online subscribers (custodians) go to [www.intermediaryonline.com](http://www.intermediaryonline.com)

For your proxy appointment to be effective it must be received by 11:00am (AEST) on Wednesday, 9 April 2025.



### ATTENDING THE MEETING IN PERSON

The meeting will be held at:  
Royal Automotive Club of Victoria,  
Level 1, 501 Bourke Street, Melbourne VIC 3000

You may elect to receive meeting-related documents, or request a particular one, in electronic or physical form and may elect not to receive annual reports. To do so, contact Computershare.

# XANADU MINES

XANADU MINES LTD  
ABN 92 114 249 026

XAM

MR SAM SAMPLE  
FLAT 123  
123 SAMPLE STREET  
THE SAMPLE HILL  
SAMPLE ESTATE  
SAMPLEVILLE VIC 3030

## Need assistance?



**Phone:**

1300 855 080 (within Australia)  
+61 3 9415 4000 (outside Australia)



**Online:**

[www.investorcentre.com/contact](http://www.investorcentre.com/contact)



## YOUR VOTE IS IMPORTANT

For your proxy appointment to be effective it must be received by **11:00am (AEST) on Wednesday, 9 April 2025.**

# Proxy Form

## How to Vote on Items of Business

All your securities will be voted in accordance with your directions.

### APPOINTMENT OF PROXY

**Voting 100% of your holding:** Direct your proxy how to vote by marking one of the boxes opposite each item of business. If you do not mark a box your proxy may vote or abstain as they choose (to the extent permitted by law). If you mark more than one box on an item your vote will be invalid on that item.

**Voting a portion of your holding:** Indicate a portion of your voting rights by inserting the percentage or number of securities you wish to vote in the For, Against or Abstain box or boxes. The sum of the votes cast must not exceed your voting entitlement or 100%.

**Appointing a second proxy:** You are entitled to appoint up to two proxies to attend the meeting and vote on a poll. If you appoint two proxies you must specify the percentage of votes or number of securities for each proxy, otherwise each proxy may exercise half of the votes. When appointing a second proxy write both names and the percentage of votes or number of securities for each in Step 1 overleaf.

**A proxy need not be a securityholder of the Company.**

### SIGNING INSTRUCTIONS FOR POSTAL FORMS

**Individual:** Where the holding is in one name, the securityholder must sign.

**Joint Holding:** Where the holding is in more than one name, all of the securityholders should sign.

**Power of Attorney:** If you have not already lodged the Power of Attorney with the registry, please attach a certified photocopy of the Power of Attorney to this form when you return it.

**Companies:** Where the company has a Sole Director who is also the Sole Company Secretary, this form must be signed by that person. If the company (pursuant to section 204A of the Corporations Act 2001) does not have a Company Secretary, a Sole Director can also sign alone. Otherwise this form must be signed by a Director jointly with either another Director or a Company Secretary. Please sign in the appropriate place to indicate the office held. Delete titles as applicable.

### PARTICIPATING IN THE MEETING

#### Corporate Representative

If a representative of a corporate securityholder or proxy is to participate in the meeting you will need to provide the appropriate "Appointment of Corporate Representative". A form may be obtained from Computershare or online at [www.investorcentre.com/au](http://www.investorcentre.com/au) and select "Printable Forms".

## Lodge your Proxy Form:

**XX**

### Online:

Lodge your vote online at [www.investorvote.com.au](http://www.investorvote.com.au) using your secure access information or use your mobile device to scan the personalised QR code.

Your secure access information is



**Control Number: 999999**

**SRN/HIN: I999999999**

**PIN: 99999**

For Intermediary Online subscribers (custodians) go to [www.intermediaryonline.com](http://www.intermediaryonline.com)

### By Mail:

Computershare Investor Services Pty Limited  
GPO Box 242  
Melbourne VIC 3001  
Australia

### By Fax:

1800 783 447 within Australia or  
+61 3 9473 2555 outside Australia



**PLEASE NOTE:** For security reasons it is important that you keep your SRN/HIN confidential.

You may elect to receive meeting-related documents, or request a particular one, in electronic or physical form and may elect not to receive annual reports. To do so, contact Computershare.

MR SAM SAMPLE  
FLAT 123  
123 SAMPLE STREET  
THE SAMPLE HILL  
SAMPLE ESTATE  
SAMPLEVILLE VIC 3030

**Change of address.** If incorrect, mark this box and make the correction in the space to the left. Securityholders sponsored by a broker (reference number commences with 'X') should advise your broker of any changes.



I 9999999999

I ND

# Proxy Form

Please mark  to indicate your directions

## Step 1 Appoint a Proxy to Vote on Your Behalf

XX

I/We being a member/s of Xanadu Mines Ltd hereby appoint

the Chairman of the Meeting **OR**

**PLEASE NOTE:** Leave this box blank if you have selected the Chairman of the Meeting. Do not insert your own name(s).

or failing the individual or body corporate named, or if no individual or body corporate is named, the Chairman of the Meeting, as my/our proxy to act generally at the meeting on my/our behalf and to vote in accordance with the following directions (or if no directions have been given, and to the extent permitted by law, as the proxy sees fit) at the Extraordinary General Meeting of Xanadu Mines Ltd to be held at the Royal Automotive Club of Victoria, Level 1, 501 Bourke Street, Melbourne VIC 3000 on Friday, 11 April 2025 at 11:00am (AEST) and at any adjournment or postponement of that meeting.

## Step 2 Items of Business

**PLEASE NOTE:** If you mark the **Abstain** box for an item, you are directing your proxy not to vote on your behalf on a show of hands or a poll and your votes will not be counted in computing the required majority.

		For	Against	Abstain
Resolution 1	Approval to exercise 25% Put Option in respect of Khuiten Metals Pte Ltd	<input type="checkbox"/>	<input type="checkbox"/>	<input type="checkbox"/>
Resolution 2	Ratification of prior issue of 110,000,004 shares	<input type="checkbox"/>	<input type="checkbox"/>	<input type="checkbox"/>

For personal use only

The Chairman of the Meeting intends to vote undirected proxies in favour of each item of business. In exceptional circumstances, the Chairman of the Meeting may change his/her voting intention on any resolution, in which case an ASX announcement will be made.

## Step 3 Signature of Securityholder(s) *This section must be completed.*

Individual or Securityholder 1 <input type="text"/>	Securityholder 2 <input type="text"/>	Securityholder 3 <input type="text"/>	/ /
Sole Director & Sole Company Secretary	Director	Director/Company Secretary	Date

**Update your communication details** (Optional)

By providing your email address, you consent to receive future Notice of Meeting & Proxy communications electronically

Mobile Number <input type="text"/>	Email Address <input type="text"/>
---------------------------------------	---------------------------------------

