

For personal use only

# Green helium for a hi-tech world.



Ready to drill  
in Q3 2023.

Justyn Wood  
Co-founder and CEO

9 May  
2023

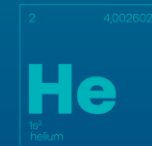

# Disclaimer

This presentation has been prepared by Noble Helium Limited (ACN 603 664 268) (**Noble Helium** or **Company**) and contains background information about Noble Helium's current situation at the date of this presentation. The presentation is in summary form and does not purport to be all inclusive or complete.

Noble Helium has issued a prospectus dated 18 February 2022 in connection with its proposed initial public offering of shares and listing on the Australian Securities Exchange (**Prospectus**). Accordingly, this presentation should be read in conjunction with the Prospectus. Any person who wishes to apply for shares in Noble Helium will need to apply under the Prospectus by completing an application form accompanying the Prospectus. Comprehensive details regarding Noble Helium and its projects are set out in the Prospectus.

Recipients should conduct their own investigations and perform their own analysis in order to satisfy themselves as to the accuracy and completeness of the information, statements and opinions contained in this presentation. This presentation is for information purposes only. Neither this presentation nor the information contained in it constitutes an offer, invitation, solicitation or recommendation in relation to the purchase or sales of shares or other securities in any jurisdiction. This presentation is not a prospectus, product disclosure statement or other offering document under Australian law (and will not be lodged with the Australian Securities and Investments Commission) or any other law.

This presentation does not constitute investment or financial product advice (nor tax, accounting or legal advice) and has been prepared without taking into account the recipient's investment objectives, financial circumstances or particular needs and the opinions and recommendations in this presentation are not intended to represent recommendations of particular investments to particular persons. Recipients should seek professional advice when deciding if an investment is appropriate. All securities involve risks which include (among others) the risk of adverse or unanticipated market, financial or political developments. Details regarding the risks associated with an investment in the Company are set out in the Prospectus.

This presentation may include forward-looking statements. Forward-looking statements are only predictions and are subject to risks, uncertainties and assumptions which are outside the control of Noble Helium. Actual values, results or events may be materially different to those expressed or implied in this presentation. Given these uncertainties, recipients are cautioned not to place reliance on forward looking statements.

No reserves have been assigned in connection with the Company's property interests to date, given their early stage of development. Unrisked Prospective Helium Volumes have been defined. However, estimating helium volumes is subject to significant uncertainties associated with technical data and the interpretation of that data, future commodity prices, and development and operating costs. There can be no guarantee that Noble Helium will successfully convert its helium resource to reserves and produce that estimated volume.

## Competent Person's Statement

The prospective volumes are for helium, which are not hydrocarbons. However, Netherland, Sewell & Associates, Inc. have used the definitions and guidelines set forth in the 2018 Petroleum Resources Management System (**SPE-PRMS**) approved by the Society of Petroleum Engineers as the framework to classify these helium volumes as "prospective". The SPE-PRMS is specifically designed for hydrocarbons, which helium is not, however the principles and methods for hydrocarbon gas resource estimation are directly applicable to helium gas volume estimation.

The prospective helium volumes included in this presentation should not be construed as petroleum reserves, petroleum contingent resources, or petroleum prospective resources. They represent exploration opportunities and quantify the development potential in the event a helium discovery is made. The information in this presentation which relates to prospective helium volumes is based on, and fairly represents, in the form and context in which it appears, information and supporting documents prepared by, or under the supervision of, Alexander Karpov and Zachary Long.

Alexander Karpov is an employee of Netherland, Sewell & Associates, Inc. Alexander Karpov attended Texas A&M University and graduated in 2001 with a Master of Science Degree in Petroleum Engineering, and attended the Moscow Institute of Oil and Gas and graduated in 1992 with a Bachelor of Science Degree in Petroleum Geology. Alexander Karpov is a Licensed Professional Engineer in the State of Texas, United States of America and has in excess of 26 years of experience in petroleum engineering studies and evaluations. Alexander Karpov has sufficient experience to qualify as a qualified petroleum reserves and resources evaluator as defined in the ASX Listing Rules.

Zachary Long is an employee of Netherland, Sewell & Associates, Inc. Zachary Long attended Texas A&M University and graduated in 2005 with a Master of Science Degree in Geophysics, and attended the University of Louisiana at Lafayette and graduated in 2003 with a Bachelor of Science Degree in Geology. Zachary Long is a Licensed Professional Geoscientist in the State of Texas, United States of America and has in excess of 16 years of experience in geological and geophysical studies and evaluations. Zachary Long has sufficient experience to qualify as a qualified petroleum reserves and resources evaluator as defined in the ASX Listing Rules.

Alexander Karpov, Zachary Long and Netherland, Sewell & Associates, Inc. have each consented to the inclusion in this presentation of the matters based on this information in the form and context in which they appear.

For personal use only

# The pitch

A ground-floor investment in the potential discovery and development of the world's largest **green helium** reserve.



# More than balloons and blimps.

There's no technology without helium. It's an irreplaceable input for many important technologies with significant demand growth from manufacturers of semiconductors used in computers, mobile phones, cars, (even kids' toys).

For personal use only

- 01 Favourable market
- 02 Experienced team
- 03 World class assets
- 04 Green helium

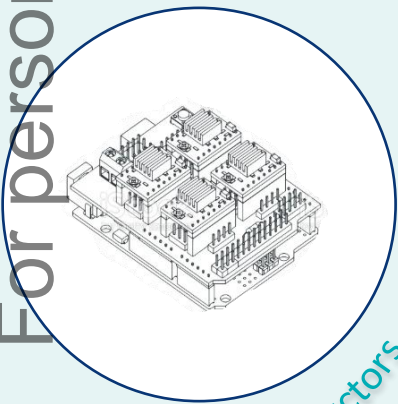

Semi-conductors

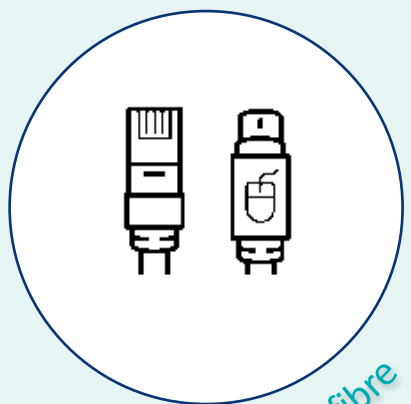

Optical fibre

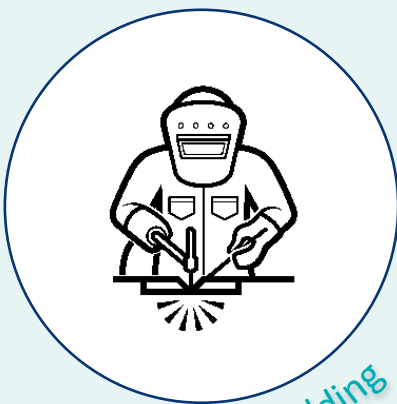

Welding

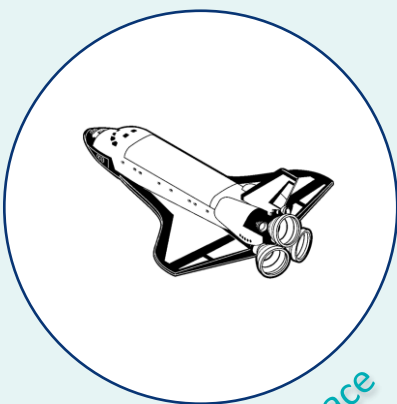

Aerospace

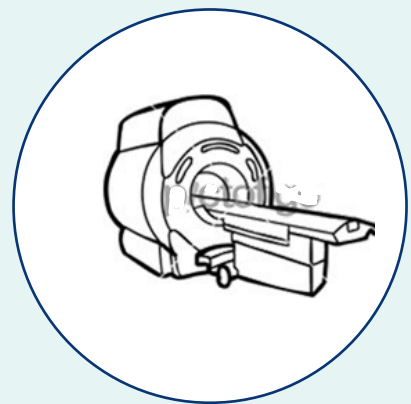

MRI



Cryogenics



# The value of the global helium market is growing.

For personal use only

The global helium market size is expected to grow from an estimated \$5 billion in 2023 to over

# \$8.00 billion in 2030

at a CAGR of 6.6%.

Estimated global helium market  
US\$ billions

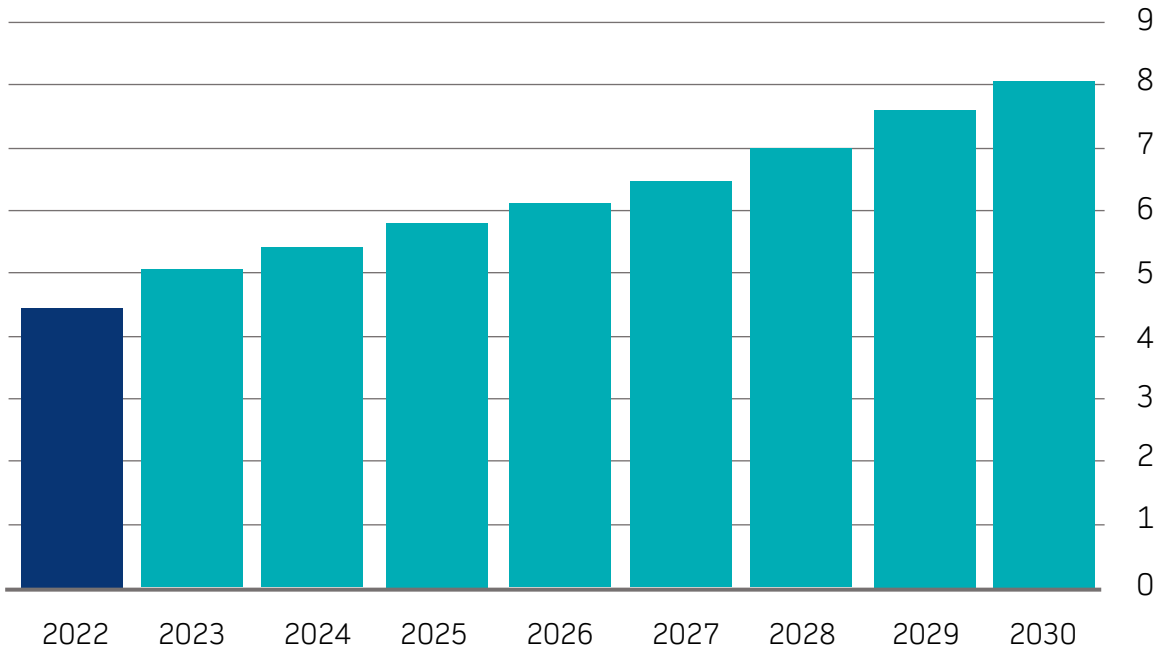

Actual  
Forecast



Source: The Business Research Company, Helium Global Market Report 2023  
Published January 2023

# Helium supply is fragile. Very fragile.

Currently experiencing the fourth worldwide helium shortage since 2006.

-  USA - BLM federal reserve depleted
-  Russia – around one third of world supply by 2027 but troubled by Amur plant startup fires coupled with growing geopolitical tensions.
-  Qatar – 30% of world supply. Embargoed for six weeks in June 2017
-  Algeria – normally 8% of world supply; Skikda LNG feed redirected to Europe.

## Decoupling from gas production, and geopolitical diversification is the best solution for a secure global helium supply chain.

For personal use only

The helium price is surging with transition to market pricing and fragile supply.

March 2023 Long-term contract bulk liquid helium pricing

US\$450/Mscf

That's 50 times the price of LNG!

Historical price of bulk liquid helium  
US\$/thousand standard cubic feet (Mscf)

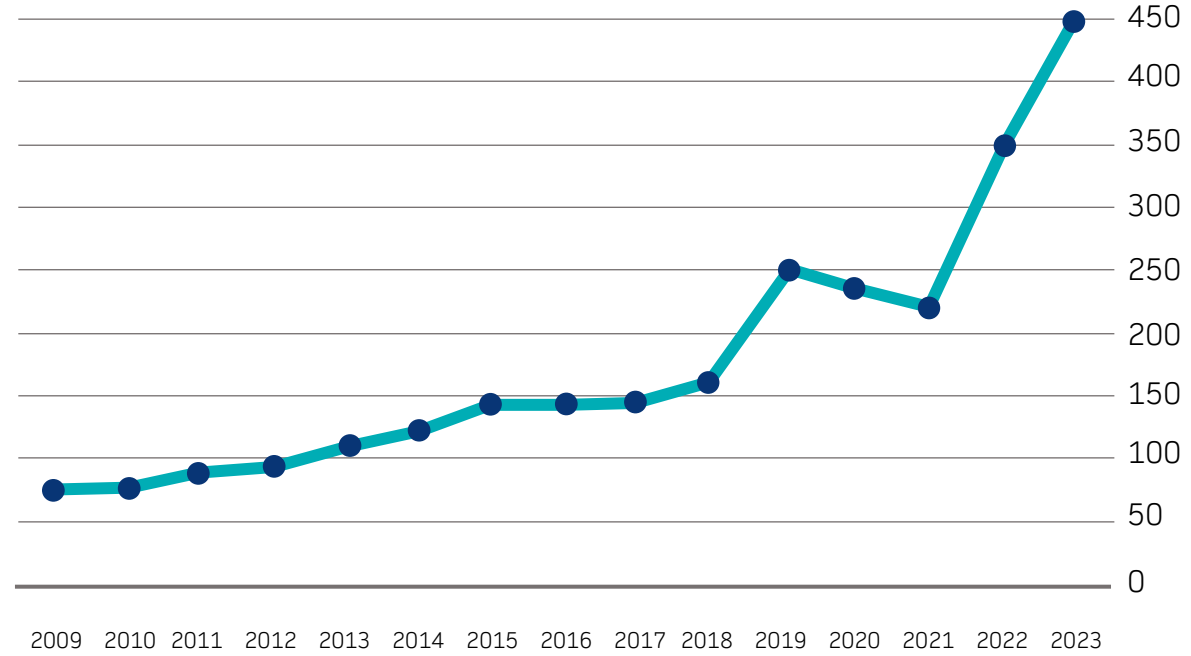

Source: Kornbluth Consulting LLC



# Noble Helium is owner operated and led by two oil and gas pioneers.

For personal use only



**Justyn Wood, Chief Executive Officer**

The Exploration Geophysicist who helped put the East African Rift System on the world oil and gas map.

Built Noble Helium over many years and holds more than a third of the company’s shares, so is heavily incentivised to deliver value for shareholders.

He knows the ground the company is working on.

Justyn has nearly 30 years of E&P industry experience in both technical and management roles at Hardman Resources, Chevron Australia, Repsol Australia and Oil Company of Australia.

Made key contributions to the first oil discoveries in South America’s Guyana margin as well.



**Shaun Scott, Chairman**

Helped pioneer Queensland coal seam gas industry from “novelty” status to a \$20 billion per year export industry.

As CEO of Arrow Energy Ltd, Shaun led the growth of that business from a \$20m coal seam gas explorer until its \$3.5 billion acquisition by Shell and Petro-China.

Highly experienced independent non-executive director on publicly listed and private company boards. Currently a non-executive director of ASX listed Comet Ridge Ltd.



For personal use only

# Plus we have a wealth of global resources experience in our team.



**Kent Masters, Anchor Investor**

A core early investor in Noble Helium, Kent is Chairman, CEO and President of Albermarle, one of the world's largest lithium companies.

As former Executive Director of Linde, the world's largest industrial gas company by market share and revenue (capped at ~US\$160B), Kent held responsibility for the Americas, Africa, East Asia, South Pacific. And helium.

He knows his industrial gases and has a network that stretches across the world and includes project developers and off-takers.



**Professor Andrew Garnett, Non-Exec Director**

Prof. Garnett is currently the Director of the University of Queensland's research Centre for Natural Gas (CNG), working closely with the main LNG project proponents in Queensland, Australia. Has over 25 years of international experience in senior technical, management and executive roles in the upstream oil and gas sector including with Shell and Schlumberger.



**Eddie King, Non-Executive Director**

Executive and non-executive board member of a number of ASX-listed resources companies., including Bindi Metals, Queensland Pacific Metals, Six Sigma Metals, Pure Minerals, and European Cobalt. Serves as a director of CPS Capital, a corporate finance and stockbroking firm with offices in Perth and Melbourne.

## We're also working with two of the world's foremost helium geoscientists.

Noble Helium commissioned, and has exclusively licensed, the world's first 'Helium Atlas' from Global Helium Resources, who's two foremost helium experts – Dr. Jon Gluyas of Durham University and Dr. Chris Ballentine of Oxford – were key in its development.

- A detailed global study of helium potential.
- The Atlas has confirmed Tanzania as the most prospective, untested helium system in the world.
- Access to Drs Gluyas and Ballantine and the 'Helium Atlas' will also help Noble Helium in selecting future helium project acquisitions.

We're writing the book on helium. Literally.



For personal use only

For personal use only

# Four primary helium projects along Tanzania's East African Rift System.

If Noble's resource can be proven, it has the potential to be the world's third largest helium resource behind the USA and Qatar, and the largest ever helium reserve not associated with hydrocarbons.

- 01 Favourable market
- 02 Experienced team
- 03 World class assets
- 04 Green helium

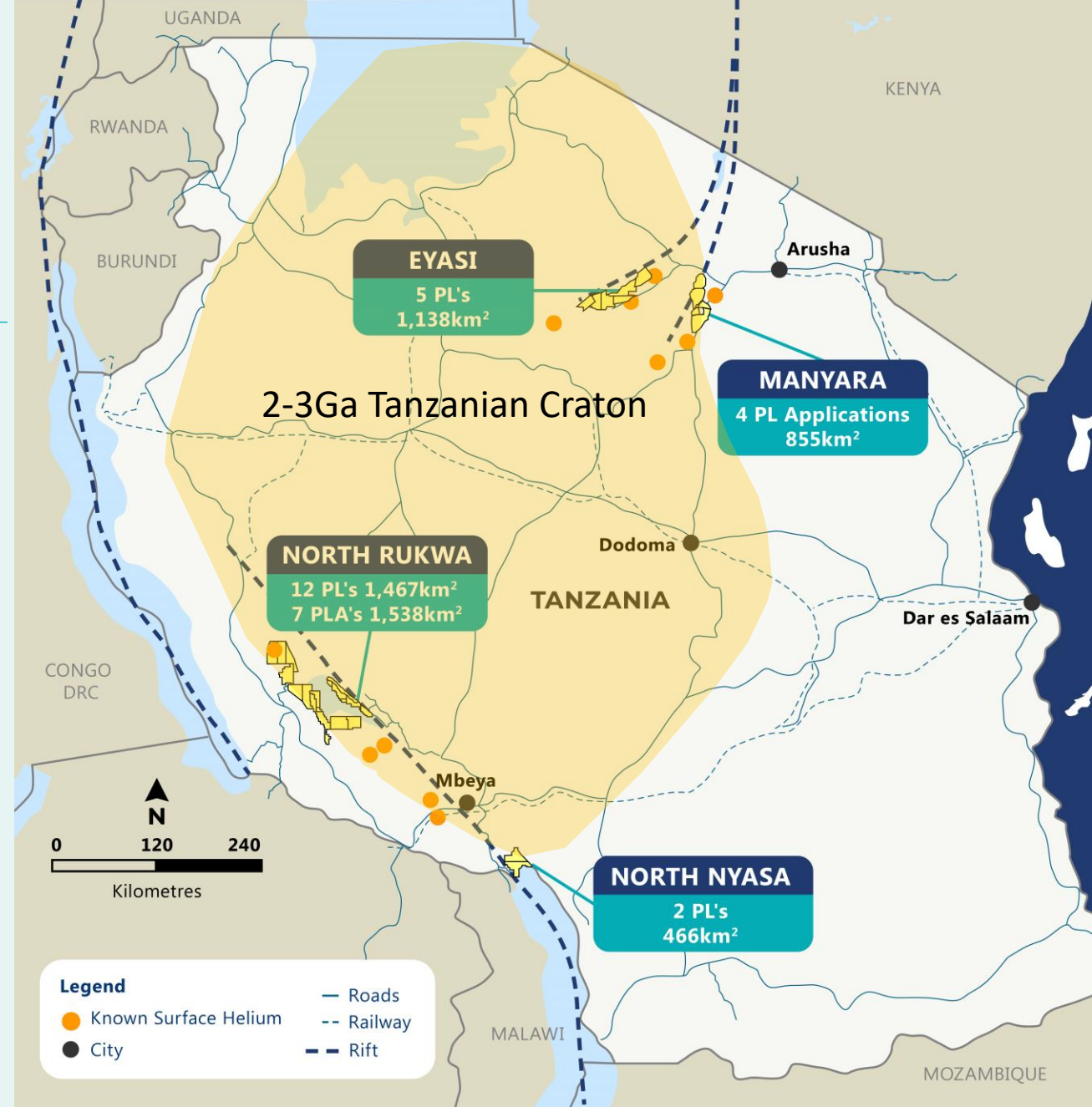



# We're drilling our first two holes next quarter.

The two targets, Mbelele-1 and Pegere-1, host a combined unrisks mean recoverable helium volume of **16.5 billion cubic feet**, representing less than 10% of the North Rukwa Project's helium resource.



For personal use only

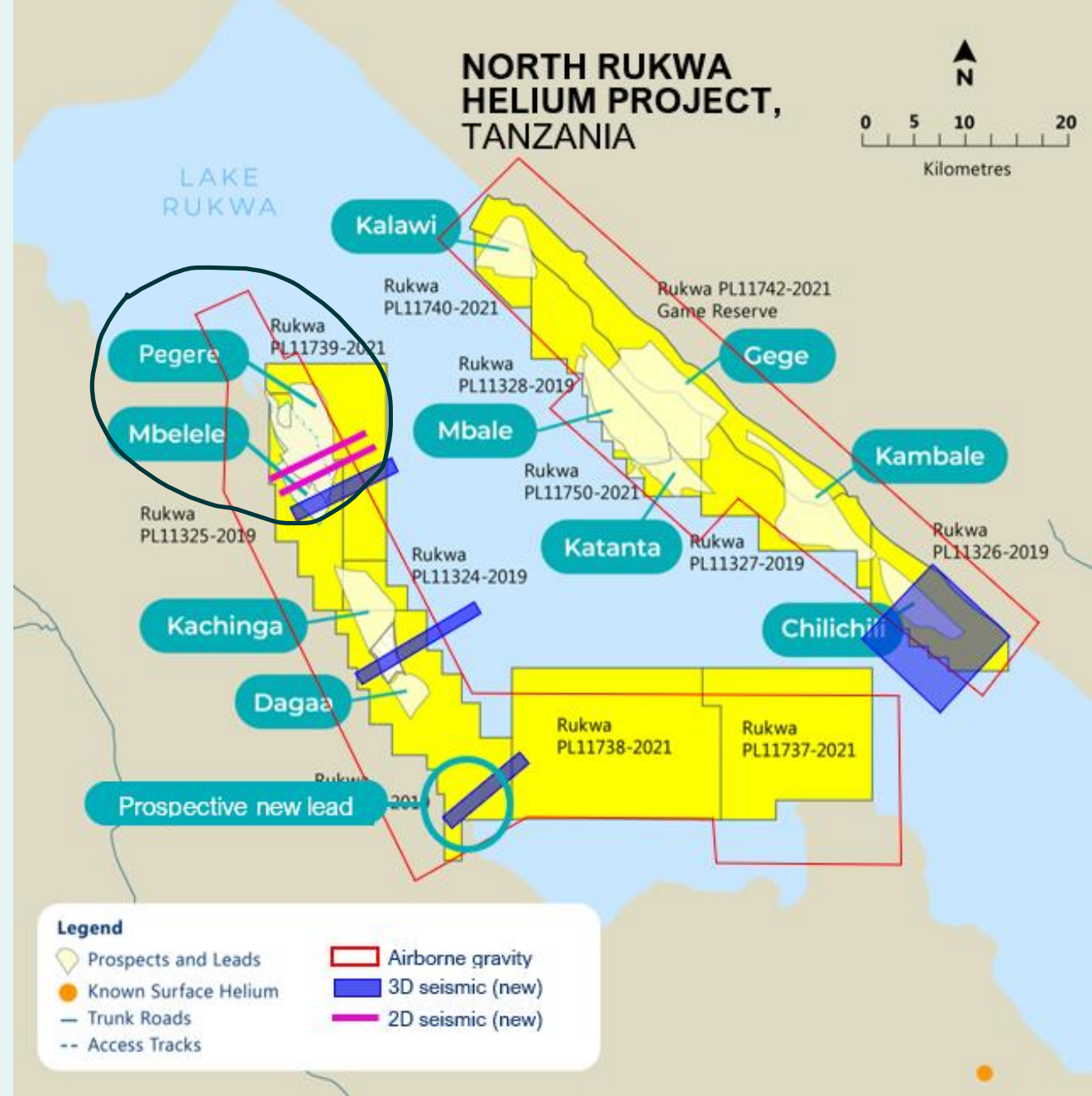



# We've spent seven years pinpointing these wells.

- Selected for their high probability of discovering gas-phase helium.
- Pegere-1 will offer the opportunity to also be an appraisal well for Mbelele-1.
- Rig secured.

16.5 billion cubic feet value  
**US\$7.5 billion**  
 @US\$450/Mscf of liquid helium

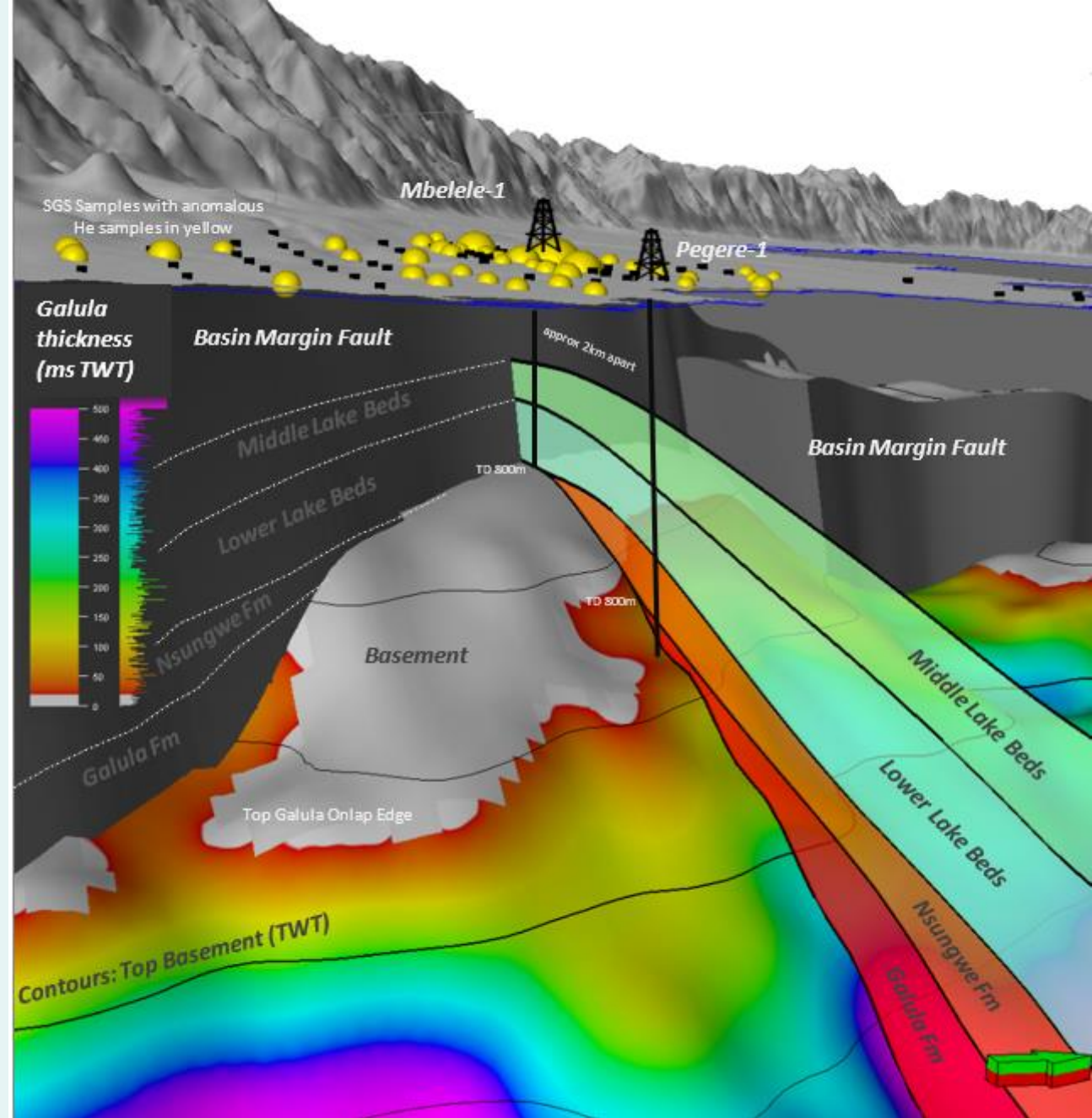





## Preferred bidder selected for North Rukwa farmout.

A non-binding Heads of Agreement signed with Prime Energy of Dubai as a nominee of the preferred bidder.

- Successful completion will result in Noble Helium being fully carried through two exploration wells to a cap of US\$20 million.
- 50% of back costs to be reimbursed, equating to approximately US\$5 million to the Company.
- Farminee will earn a 50% interest in the North Rukwa licences once the full amount of the consideration has been paid.
- Noble Helium will now progress to completion of definitive documents with preferred bidder.

For personal use only



Seismic survey being completed at North Rukwa Project in February 2023 ahead of planned drilling in Q3.

# We're confident we have a "String of Pearls" play.

For personal use only

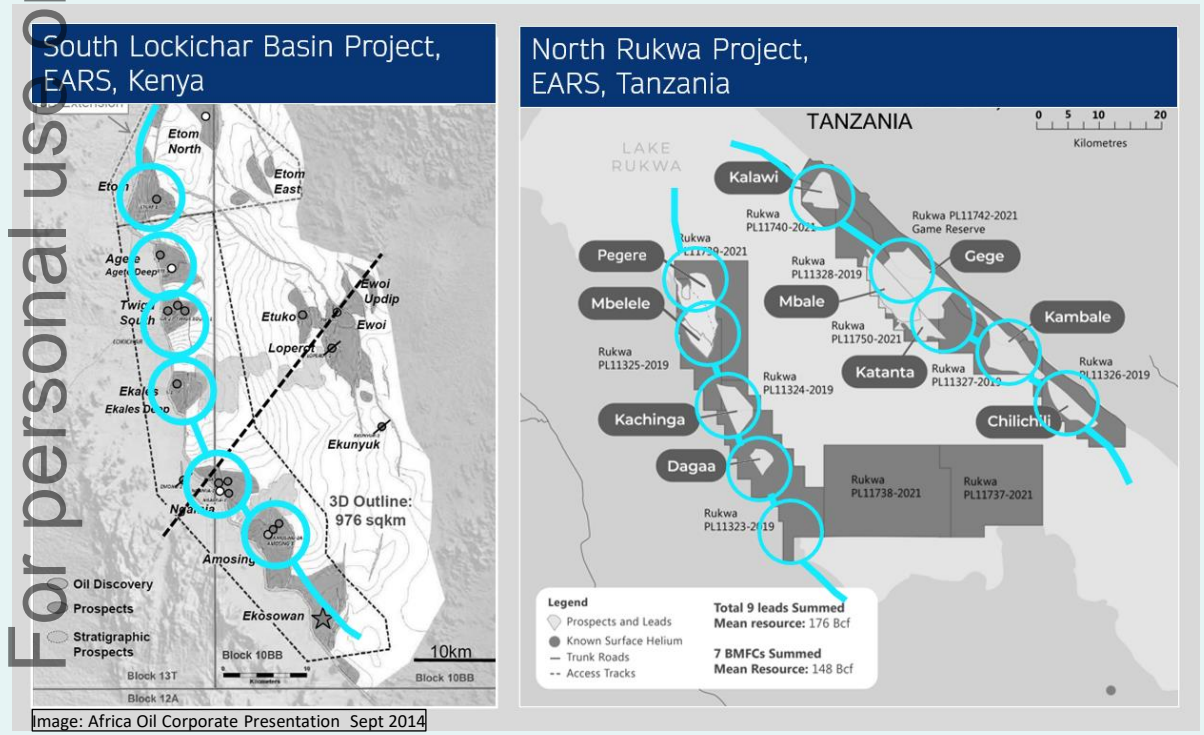

A little geology lesson won't hurt you.

- Tanzania's Rukwa Basin, which hosts the North Rukwa Project's potentially world-scale helium resource, lies within the East African Rift System (EARS). In Uganda and Kenya, the EARS has a 80% success rate from nearly 40 exploration wells, including a 100% success rate in Basin Margin Fault Closures for oil and gas wells (14 from 14) since first oil in 2006.
- EARS discoveries often present as a "String of Pearls" play made up of multiple successful wells along a trend.
- Another EARS company, Africa Oil Corp, hit a "String of Pearls" in 2012 when a successful result from its first lead was replicated along a string of leads (See Figure 3 Below).
- Noble Helium's exploration to date has discovered up to 10 leads along two strings, one on each side of the North Rukwa Project where there are Basin Margin Fault Closures. Our thesis is that if a successful result can be delivered on the first "pearl"/drillhole, there is a higher likelihood the other geologically similar pearls will deliver as well.



For personal use only

## Easy path to market.

- Helium liquefaction plant on site.
- Truck midstream liquid helium iso-containers on black-top road to Port of Dar es Salaam for global distribution.
- Direct access to national power grid and water (Lake Rukwa)

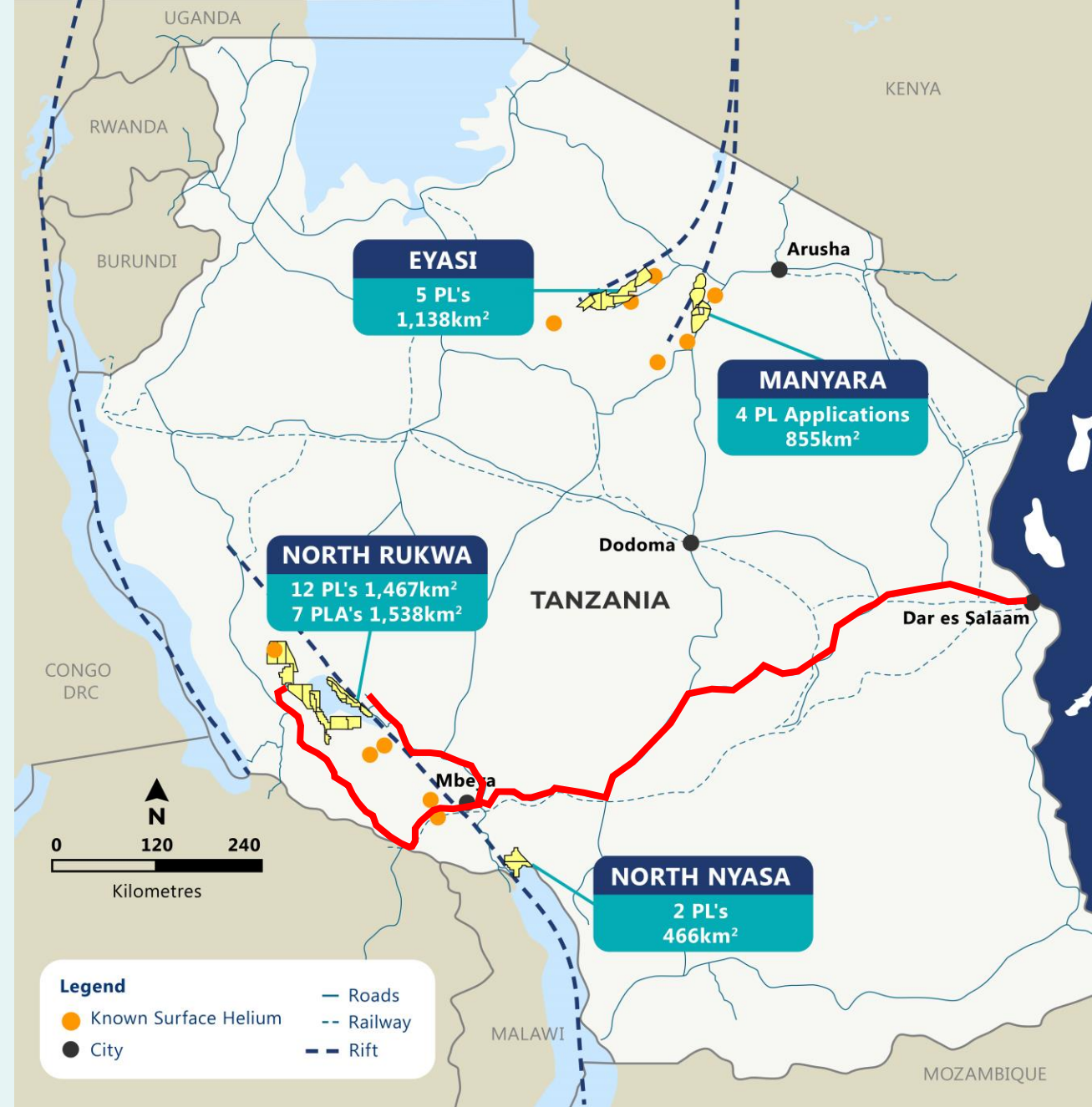



## The maths.

As a gas, helium has similar exploration/production costs per Mscf as traditional oil and gas but requires significantly less capital as much smaller volumes are required for a highly profitable project.

Discovering a 6Bcf recoverable helium resource is a company maker!

## Worked example

To achieve an annual production of

**850,000**

Mscf of liquid helium

The estimated total CAPEX 2023-2027 would be

**US\$305m**

And the estimated total OPEX (2027) would be

**US\$25m**

Estimated ultimate recovery

**12Bcf**

Over 20 years  
33% year 13 to depletion

Pricing

**US\$450**

Mscf of liquid helium

First full year production

	US\$M
Revenue	\$382.50
OPEX	\$25.00
Depreciation	\$15.25
Gross Margin	\$342.25

# Corporate snapshot.

For personal use only

Share price  
**A\$0.235c**  
 5 May 2023  
 52 week high \$0.34, low \$0.135

Market capitalisation  
**A\$52.6m**  
 5 May 2023

Debt  
**Zero**  
 31 March 2023

Shares on issue  
**223m**  
 5 May 2023

Cash  
**A\$3.0m**  
 31 March 2023

Total options  
**104m**  
 31 March 2023

ASX Share price performance (\$A)  
 12 months to 5 May 2023

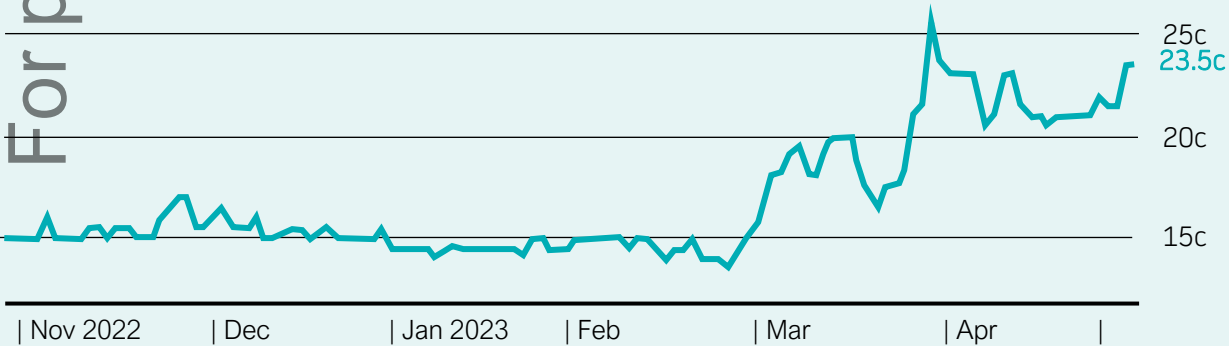

## Share register

Figures shown are approximate as at 3 February 2023

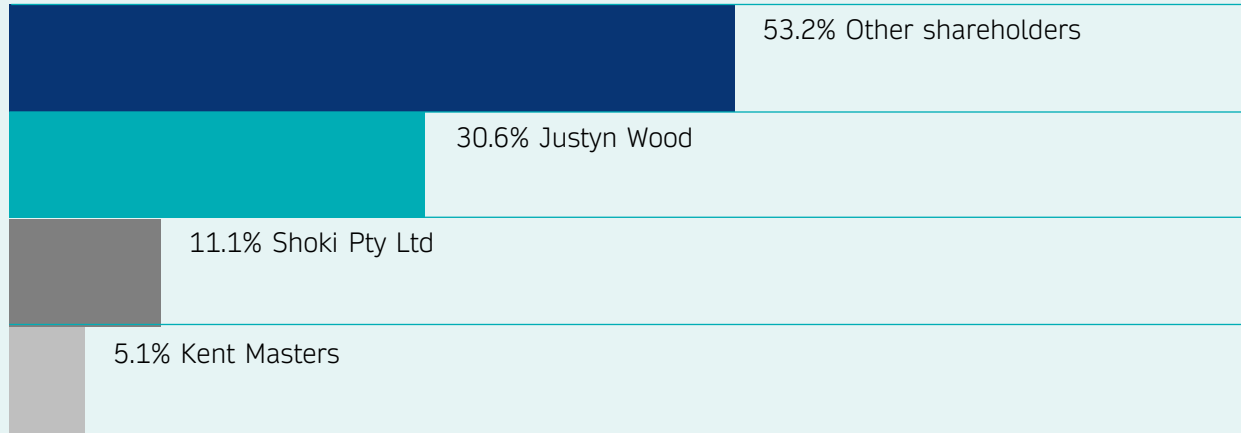

For personal use only

# Invest in the future of helium.

A ground-floor investment in the potential discovery and development of the world's largest **green helium** reserve.

Drilling in Q3.





---

## Contact

T: + 61 (0)8 9481 0389

E: [info@noblehelium.com.au](mailto:info@noblehelium.com.au)

### Registered Office

Noble Helium Limited  
Level 8, London House  
216 St. Georges Terrace, Perth  
Western Australia 6000

For personal use only